

Very intense and uniform illuminated area
 Optimized cooling system
 Full range of colors: from UV to IR, white
 Long lifetime and few maintenance
 Available from 0.1 to 6 meters

Electronics	Connectors	Standard: RD24 - 4 pins	Power: Jaeger - 3 pins
	Power supply	24V DC	
	Illumination mode	Continuous with DIM process [0-24V] – Analog voltage	
	Power consumption	Depends on the amount of LEDs	
Optics	Wavelength	Various wavelengths (from UV to IR, white)	
	Illuminance	Up to 400KLux at 10mm	
Mechanics	Weight	Depends on the amount of LEDs	
	Width x height	76.5 mm x 123 mm	
	Fastener	3 fastening profiles (1 T-nut 8 on the back aligned with optical axis and 2 additional nut M6 profiles on both sides)	
	Material	Device body: Aluminum alloy; Window: Acrylic	
Environment	Working temperature	0°C to 50°C	
	IP code	IP5X	

Application

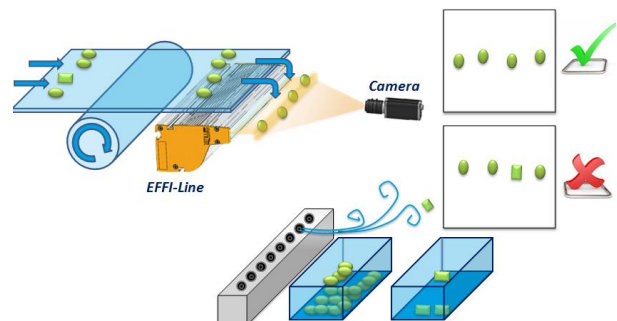
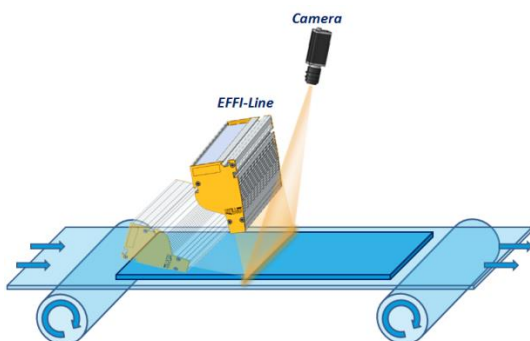

Front light and backlight for web inspection / Quality control / Surface inspection (wood, plastic, tires, cold steel, aluminum, mirror, solar panel) / Inspection of documents, prints and printing boards / Road inspection

Part Number



Reference:

EFFI-LINE-**VVV**-**XXX**-**ZZZ**-PP

XXX: Optical length (mm)

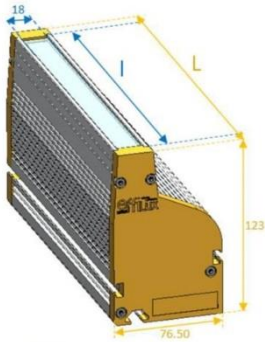

WWW:	100	200	300	400	500	...	1000	...	1500	2000	2500	...	6000
Optical length	100	200	300	400	500	...	1000	...	1500	2000	2500	...	6000
Window length: l (mm)	114	214	314	414	514	...	1014	...	1514	2014	2514	...	6014
Mechanical length: L (mm)	132	232	332	432	532	...	1032	...	1532	2032	2532	...	6032

ZZZ: Color / Wavelength (nm)

●●● RGB RGB* * Optional	● UV 405 ±10nm	● Blue 465 ±10nm	● Green 525 ±10nm	● Red 625 ±10nm	● IR 850 ±10nm	○ White 000 (T° = 5500 K ± 500 K)
----------------------------	-------------------	---------------------	----------------------	--------------------	-------------------	--------------------------------------

VVV: Version power

	EFFI-Line	EFFI-Line Power (PWR)
Cooling system	 Passive cooling	 Passive cooling + fan
Illumination at a working distance = 100mm (white)	200 000 Lux	400 000 Lux

PP: Lens Position (if not specified, default position: P1)

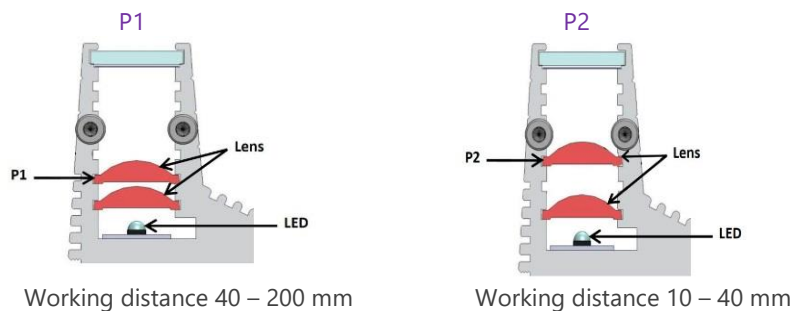

Optical considerations



Illumination versus working distance

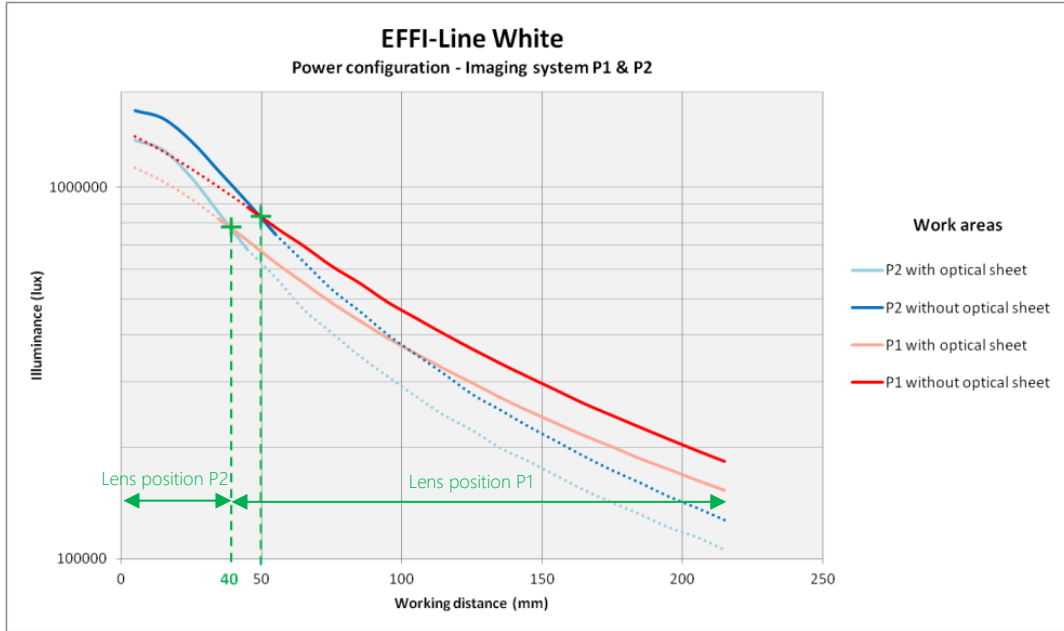

From 20% to 30% more light without optical sheet

Profile description

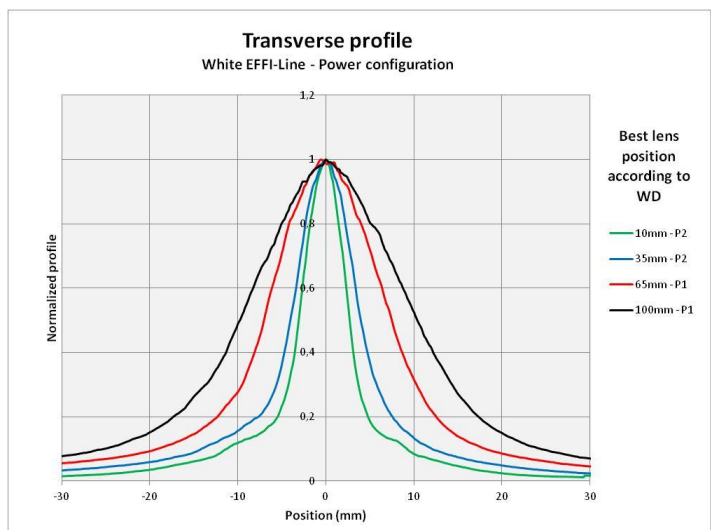
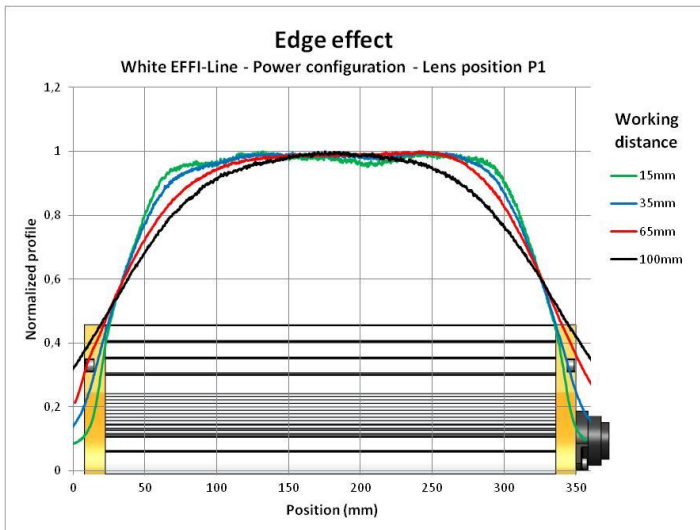
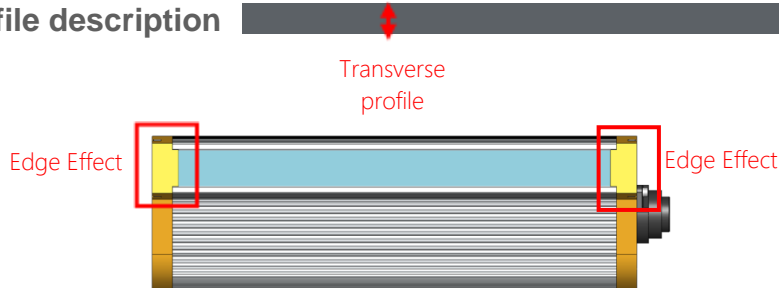



Electronical considerations

Contact arrangement

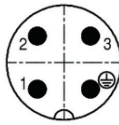
Standard Connector		
Contact arrangement	Number	Designation
 <p>RD24 Male connector</p>	1	+24V
	2	DIM – max 24V Analog Voltage
	3	GND
	4	n.a.

The EFFI-Line-2.0 is supplied with a 24V constant voltage source.

Using the DIM pin, the light intensity can be linearly increased:

- 0V - OFF
- 24V - Full ON

Power Connector		
Contact arrangement	Number	Designation
 <p>Jaeger Male connector</p>	1	+24V
	2	GND
	3	DIM – max 24V Analog Voltage

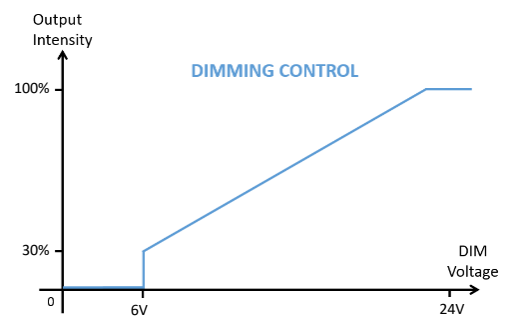

Only for version with several TRIGGER

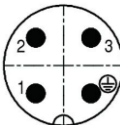
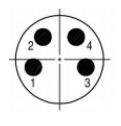
Power supply connector			Trigger Connector		
Contact arrangement	Number	Designation	Contact arrangement	Number	Designation
 <p>RD24 Male connector</p>	1	+24V	 <p>M8 Male connector</p>	1	DIM 1 – max 24V Analog Voltage
	2	n.a.		2	DIM 2 – max 24V Analog Voltage
	3	GND		3	GND
	4	n.a.		4	DIM 3 – max 24V Analog Voltage

Power supply

Formulas to determine the electrical power & the current connector of your lighting

Configuration	Electrical Power (W)	Choice of connector (A)
Standard	$P = \frac{3.5V * 0.35A}{0.9} \cdot \frac{optical\ length_{in\ mm}}{10}$	$I_{connector} = \frac{P}{24V}$
Power	$P = \frac{3.5V * 0.7A}{0.9} \cdot \frac{optical\ length_{in\ mm}}{10} + P_{fans} \cdot amount\ of\ fans$	

Electrical Power consumption (W)				
Optical length (mm): WWW	Mechanical length: L (mm)	Window length: l (mm)	Electrical Power (W) vs. Electrical power version	
			Standard	Power YYY=PWR
100	132	114	15	35
200	232	214	30	65
300	332	314	45	90
400	432	414	55	125
500	532	514	70	150
600	632	614	85	180
700	732	714	100	210
800	832	814	110	240
900	932	914	125	270
1000	1032	1014	140	300
1100	1132	1114	150	325
1200	1232	1214	165	355
1300	1332	1314	180	390
1400	1432	1414	195	415
1500	1532	1514	205	445
2000	2032	2014	275	590
2500	2532	2514	345	740
3000	3032	3014	410	885
3500	3532	3514	480	1030
4000	4032	4014	545	1180
4500	4532	4514	615	1325
5000	5032	5014	685	1470
5500	5532	5514	750	1620
6000	6032	6014	820	1765

Electical Power	Color	Amount & type of connectors
350 W		1X RD24
355W - 700W		1X Jaeger
705W - 1400W		2X Jaeger
> 1400W		Specific configuration – Contact EFFILUX for more information

Power Configuration			
Optical Length (mm)	Amount of Fans	Optical Length (mm)	Amount of Fans
100	2	1300	10
200	2	1400	10
300	2	1500	11
400	4	2000	14
500	4	2500	18
600	5	3000	21
700	6	3500	24
800	6	4000	28
900	7	4500	31
1000	8	5000	34
1100	8	5500	38
1200	9	6000	41

Mechanical considerations (dimensions in mm)

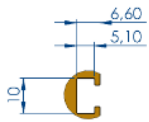
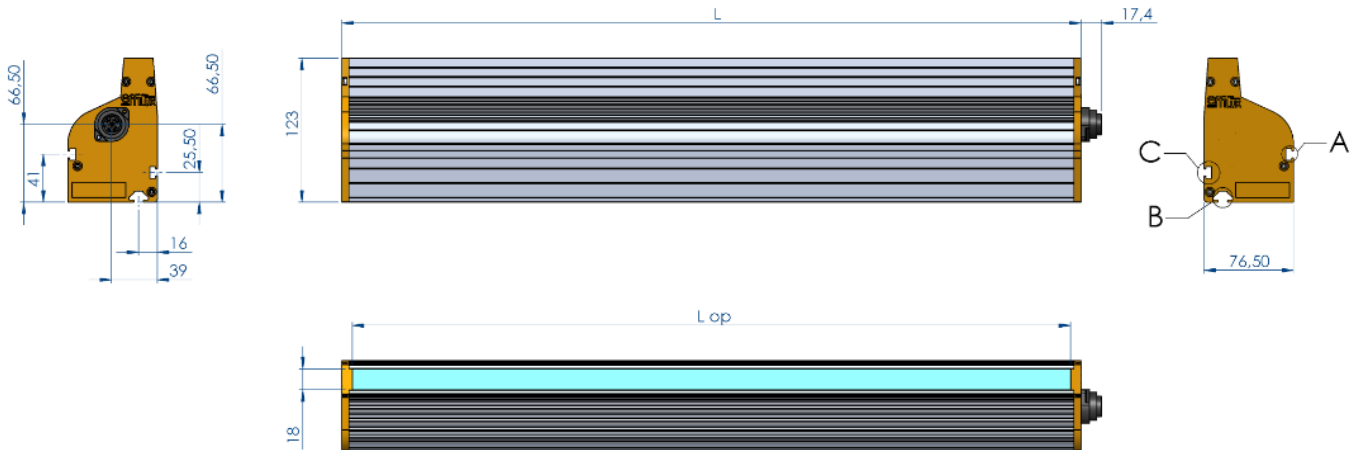

DÉTAIL A

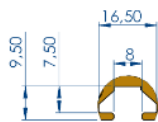

DÉTAIL B

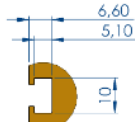

DÉTAIL C

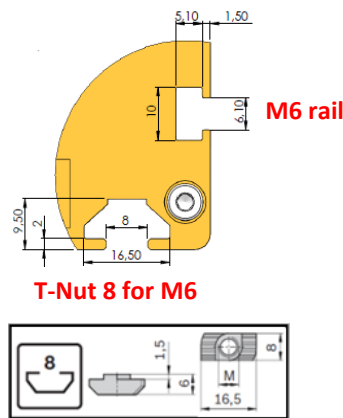
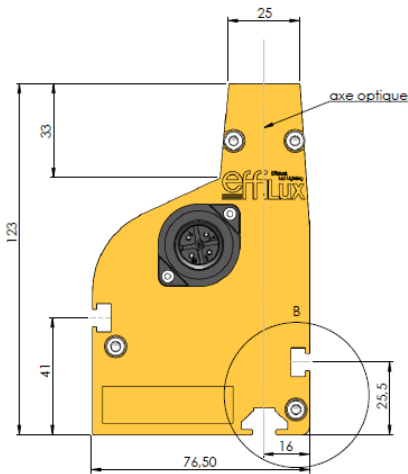

Standard version

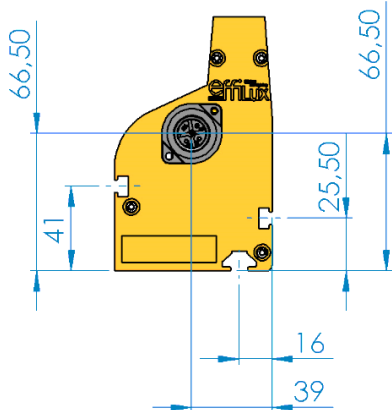

Power Version

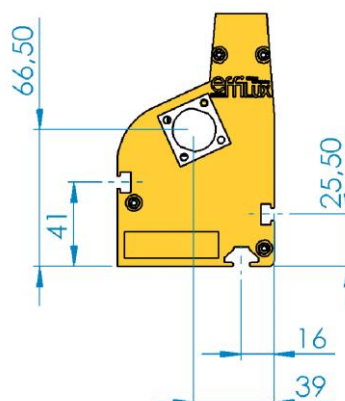

Version with different Trigger

