

This lens combines an approved Schneider-Kreuznach lens and one of Optotunes Focus Tunable Lenses EL-16-40-TC. It comes in two versions for C-Mount and TFL-Mount. To achieve a wide range of working distance the lens can be combined with an extension tube of 8mm so the liquid lens can always be used in its optimal operating range.

Key features

- Focus tunable liquid lens included
- Large working distance range
- Fast focus within milliseconds
- Large image circle

Applications

- Machine Vision
- Package sorting / logistic
- Bar code reading
- Quality control

Technical specifications

Type [liquid lens focus]	C-LF
ID [liquid lens focus]	1102609
Interface	C-Mount
Focal length [mm]	80
F/# range	F/4 ... F/32
Numerical aperture [object image]	- 0.13
Max. sensor size [mm]	24
Max. angle of view [°]	26
Rec. magnification range	-0.2 ... 0
Rec. working distance range [mm]	493 ... ∞
Max. mechanical focus travel [mm]	-
Filter thread [mm]	M37 x 0.75
Storage temperature [°C]	-25 ... +70
Net. weight [standard] [g]	-
Additional info	Liquid focus tunable lens magnification
f'eff [mm]	71.40 ... 85.16
SF [mm]	40.80 ... 73.86
S'F' [mm]	34.71 ... 41.81
HH' [mm]	-4.59 ... 1.21
β'P	1.17 ... 0.98
SEP [mm]	20.29
S'AP [mm]	-48.73 ... -41.25
Σd [mm]	62.70

MTF charts

Spectrum name	VIS					
Wavelengths [nm]	425	475	525	575	625	675
Rel. weights [%]	8	16	23	22	19	13

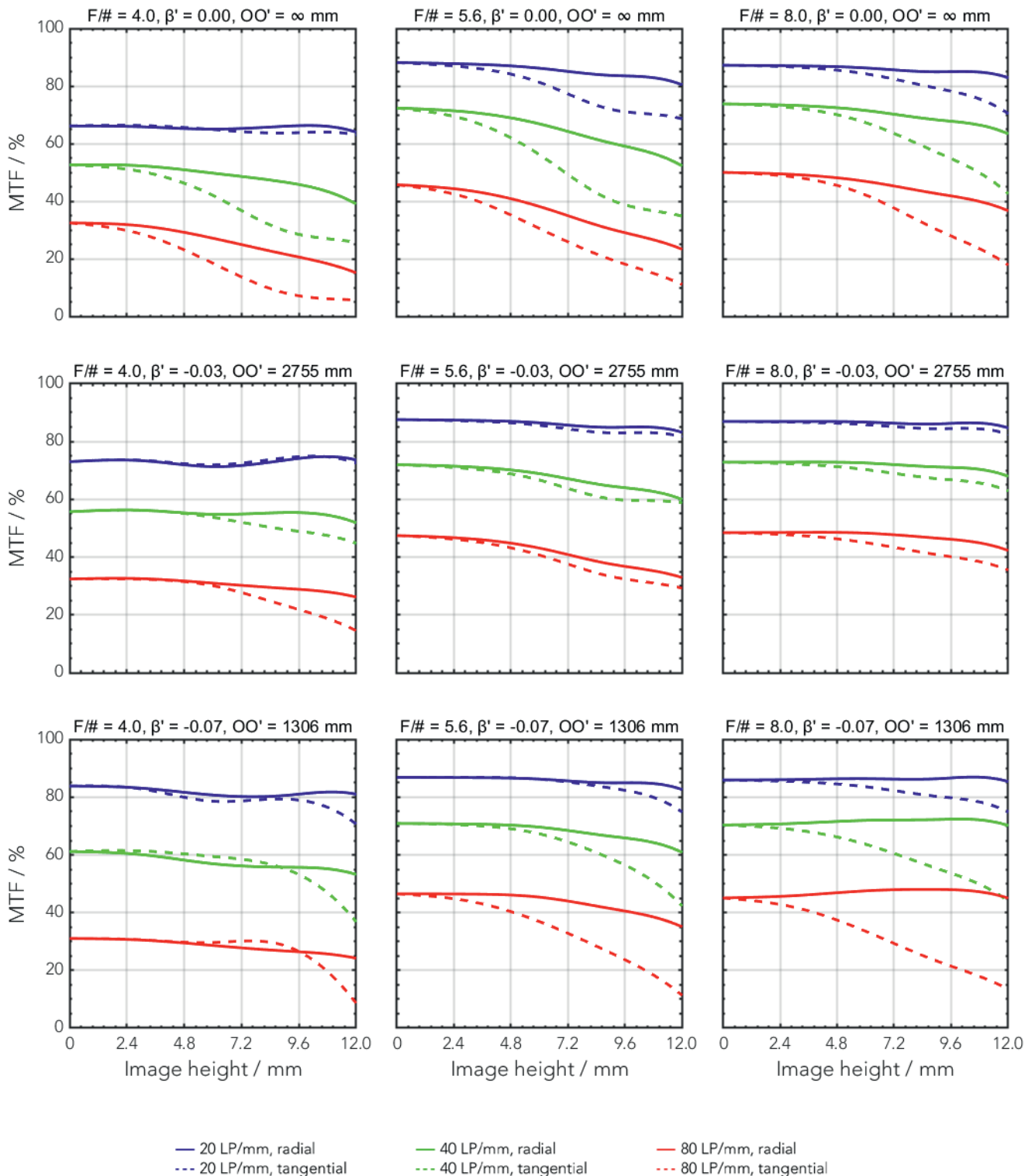

MTF charts

Spectrum name	VIS					
Wavelengths [nm]	425	475	525	575	625	675
Rel. weights [%]	8	16	23	22	19	13

To use with extension tube 7 mm

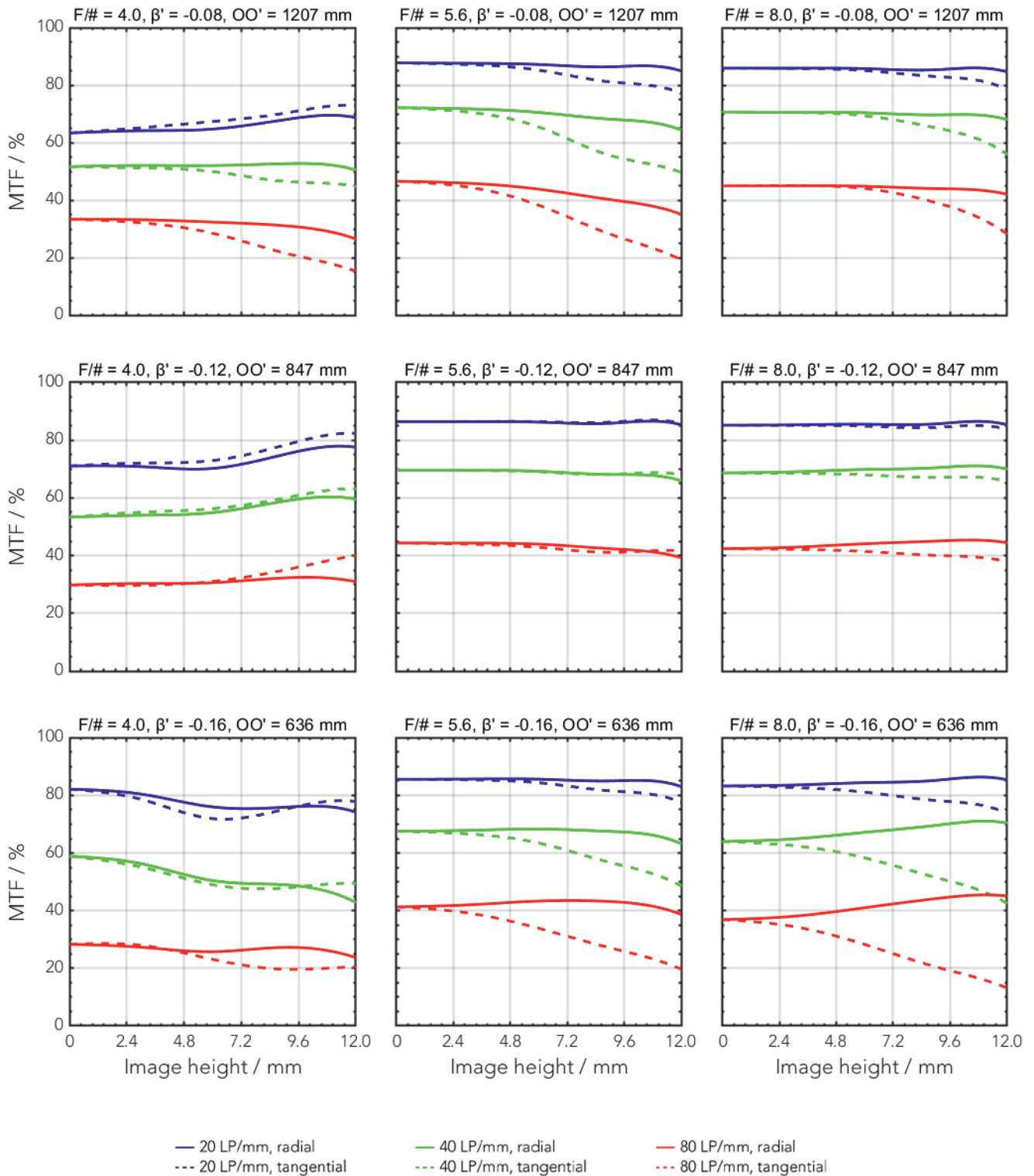

Rel. illumination vs. image height

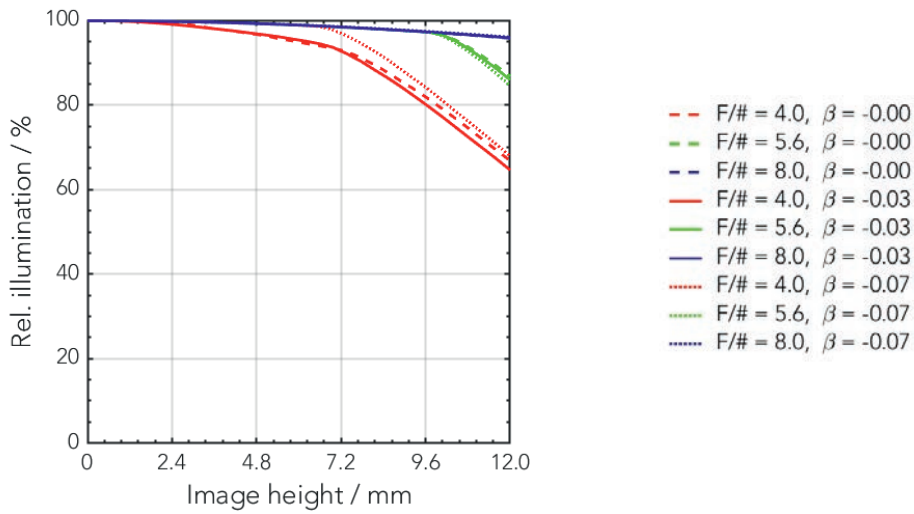

Distortion vs. image height

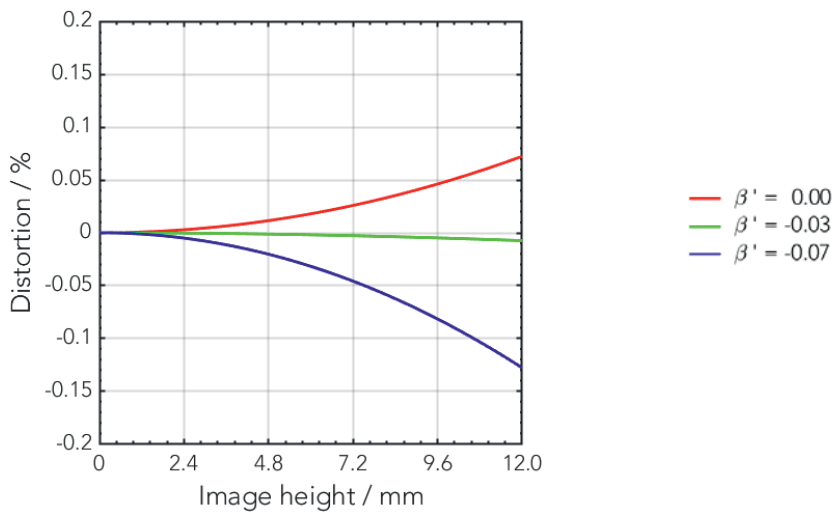

Rel. illumination vs. image height

To use with extension tube 7 mm

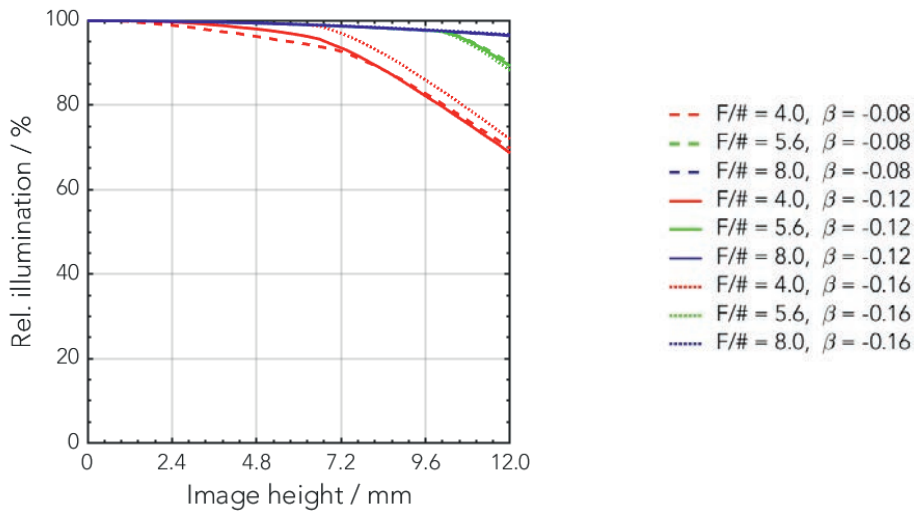

Distortion vs. image height

To use with extension tube 7 mm

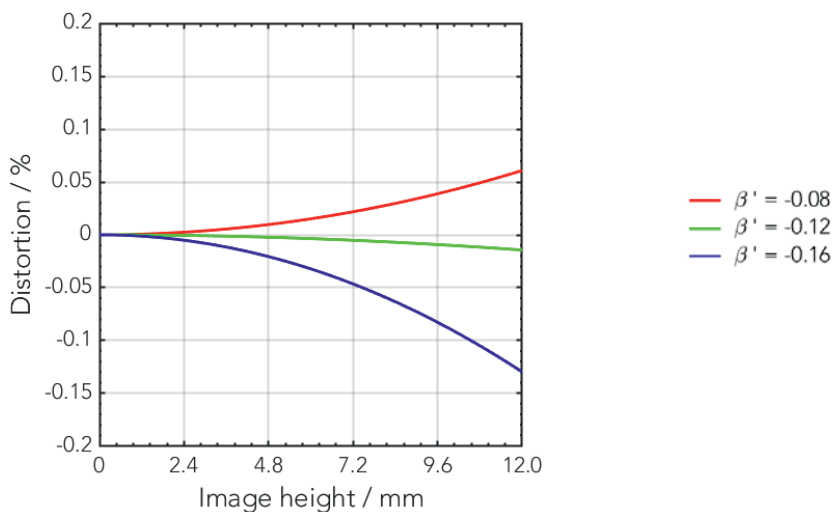

Transmittance vs. wavelength

To use with extension tube 7 mm

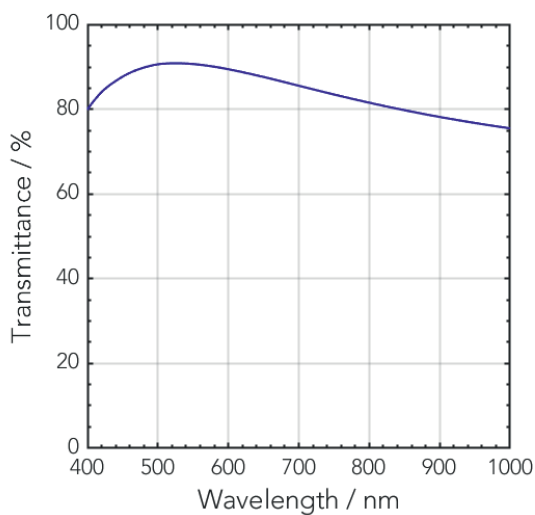

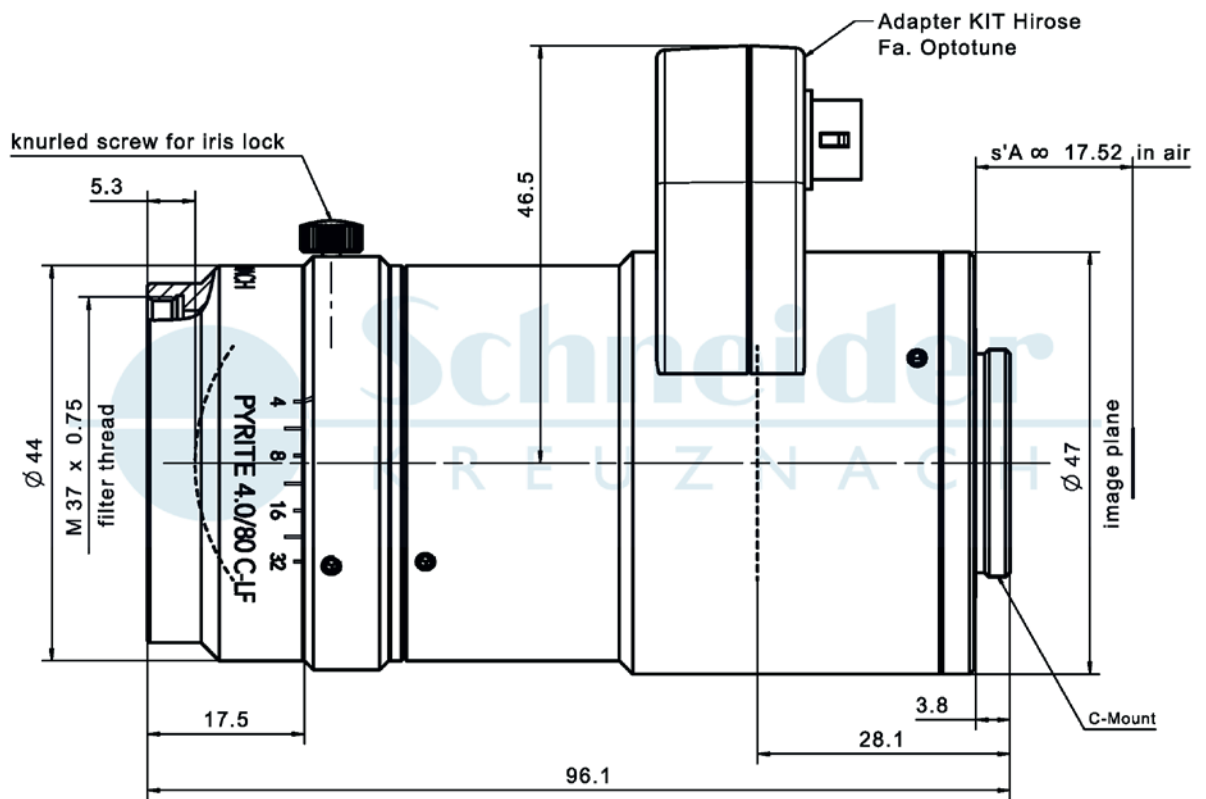

Accessories	Mount	Eff. length	ID
Adapter	C-Mount / M42x1	5.5 mm	1075817
Extension tube	C-mount / C-mount	7 mm	1105140

Annotation	
Focal length	Nominal focal length
F/# range	Image space F-number range for infinity focus position
Numerical aperture	Maximum real numerical aperture (depending on recommended magnification range either for infinity or respective fixed magnification)
Max. sensor size	Image circle diameter
Max. angle of view	Angle of view associated with maximum sensor size (depending on recommended magnification range either for infinity or respective fixed magnification)
Rec. magnification range	Magnification range as recommended by Schneider-Kreuznach
Rec. working distance range	Working distance, i.e. distance between object and first mechanical element, associated with recommended magnification range
Max. mechanical focus travel	Maximum possible movement of the lens from infinity position (depending on recommended magnification range either for infinity or respective fixed magnification)
Net weight	weight of unpacked lens without lens cap
f'_{eff}	Effective focal length
SF	Distance between vertex of first lens surface and object space focal point
S'F'	Distance between vertex of last lens surface and image space focal point (back focal distance at infinity)
HH'	Distance between principal planes
$\beta'P$	Pupil magnification (= exit pupil diameter / entrance pupil diameter)
SEP	Distance between vertex of first lens surface and entrance pupil
S'AP	Distance between vertex of last lens surface and exit pupil
Σd	Distance between vertices of first and last lens surface
s'A	Flange focal distance (in air) for infinite object distance (depending on recommended magnification range either for infinity or respective fixed magnification)
β'	Magnification (= image size / object size), negative value because image is inverted
OO'	Distance between object and image

Unless otherwise stated all dimensions in this data sheet are in mm.

Headquarters Europe

Jos. Schneider Optische Werke GmbH

Ringstraße 132

55543 Bad Kreuznach

☎ +49 671 601 205

✉ cs@schneiderkreuznach.com

www.schneiderkreuznach.com

Offices Worldwide

America

☎ +1 800 645 7239 (East Coast)

☎ +1 800 228 1254 (West Coast)

✉ info@schneideroptics.com

Asia

☎ +86 755 8832 1170

✉ info@schneider-asiapacific.com