

TECHSPEC® 6mm UC Series Fixed Focal Length Lens

#33-301



6mm FL, #33-301

Our ultra-compact, TECHSPEC® UC Series Fixed Focal Length Lenses are designed to optimize performance, cost, and size without sacrificing quality or feel. Designed for pixels that are $\leq 2.2\mu\text{m}$, these lenses provide high levels of resolution (>200 lp/mm) across the sensor and are compatible with all standard C-Mount cameras. TECHSPEC® UC Series Fixed Focal Length Lenses feature focus and iris adjustments, as well as recessed set screws, and are manufactured for use at typical machine vision working distances. While they are optimized for 1/2.5" sensors, many focal lengths will work on sensors up to 1/1.8". The TECHSPEC® UC Series Fixed Focal Length Lenses are an outstanding option for use on all smaller format camera sensors, along with both short and long working distance applications, making them ideal for inspection, [factory automation](#), biomedical devices, and a broad range of other applications.

Note: For fixed aperture instrumentation versions, see our [TECHSPEC® UCi Series Fixed Focal Length Lenses](#).

Outer Diameter (mm):	36.00
Front Thread:	M34 x 0.5 (Female)
Mounting Diameter (mm):	30.0
Optimized Sensor Format:	1/2.5"
Type:	Fixed Focal Length Lens
Coating:	$\lambda/4$ MgF ₂

Maximum Length (mm):	40.9
Imaging Lens Type:	High Performance Lens with Compact Form Factor
Storage Temperature (°C):	-20 to +60 For questions regarding operating temperature please contact our support team

Optical

Horizontal Field of View, 1/2" Sensor:	73.8mm - 60.0°
Horizontal Field of View, 1/3" Sensor:	53.4mm - 45.4°
Maximum Image Circle (mm):	8.00
Numerical Aperture NA, Object Side:	0.0255
Horizontal Field of View @ Max Sensor Format:	73.8mm - 60.0°
Horizontal Field of View, 1/2.5" Sensor:	65.9mm - 54.6°
Focal Length FL (mm):	6.00
Primary Magnification PMAG:	0.094
Maximum Sensor Format:	1/2"
Working Distance (mm):	50 - ∞
Aperture (f/#):	f/1.85 - f/11
Distortion (%):	<9.5% (on 1/2.5" Sensor)
Coating Specification:	λ/4 MgF ₂
Entrance Pupil Position (mm):	12.64
Horizontal Field of View, 1/4" Sensor:	39.2mm - 34.2°
Object Space Principal Plane (mm):	17.55
Image Space Principal Plane (mm):	4.85
Field of View at Max Sensor Format:	Horizontal: 73.8mm - 60° Vertical: 53.3mm - 45.4° Diagonal: 96.8mm - 73.8°
Maximum Distortion (%):	-11.19
Exit Pupil Position (mm):	-22.49
Lens Wavelength Range:	VIS

Mechanical

Iris Option:	Variable
Length (mm):	40.90
Filter Thread:	M43 x 0.75 with adapter #85-308
Maximum Diameter (mm):	36
Weight (g):	67
Maximum Rear Protrusion (mm):	3.2
Number of Elements (Groups):	9 (8)
Mount:	C-Mount

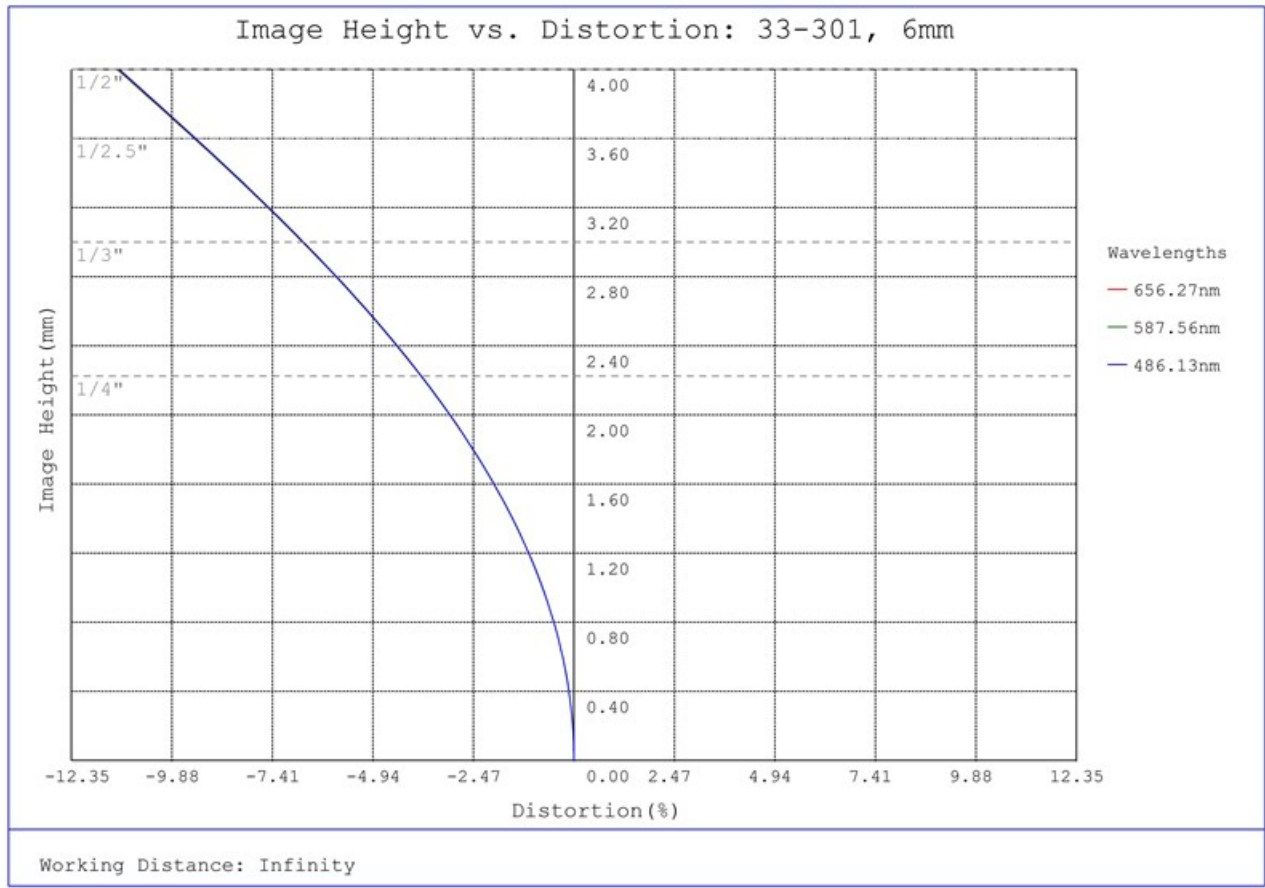

#33-301, 6mm UC Series Fixed Focal Length Lens, Distortion Plot

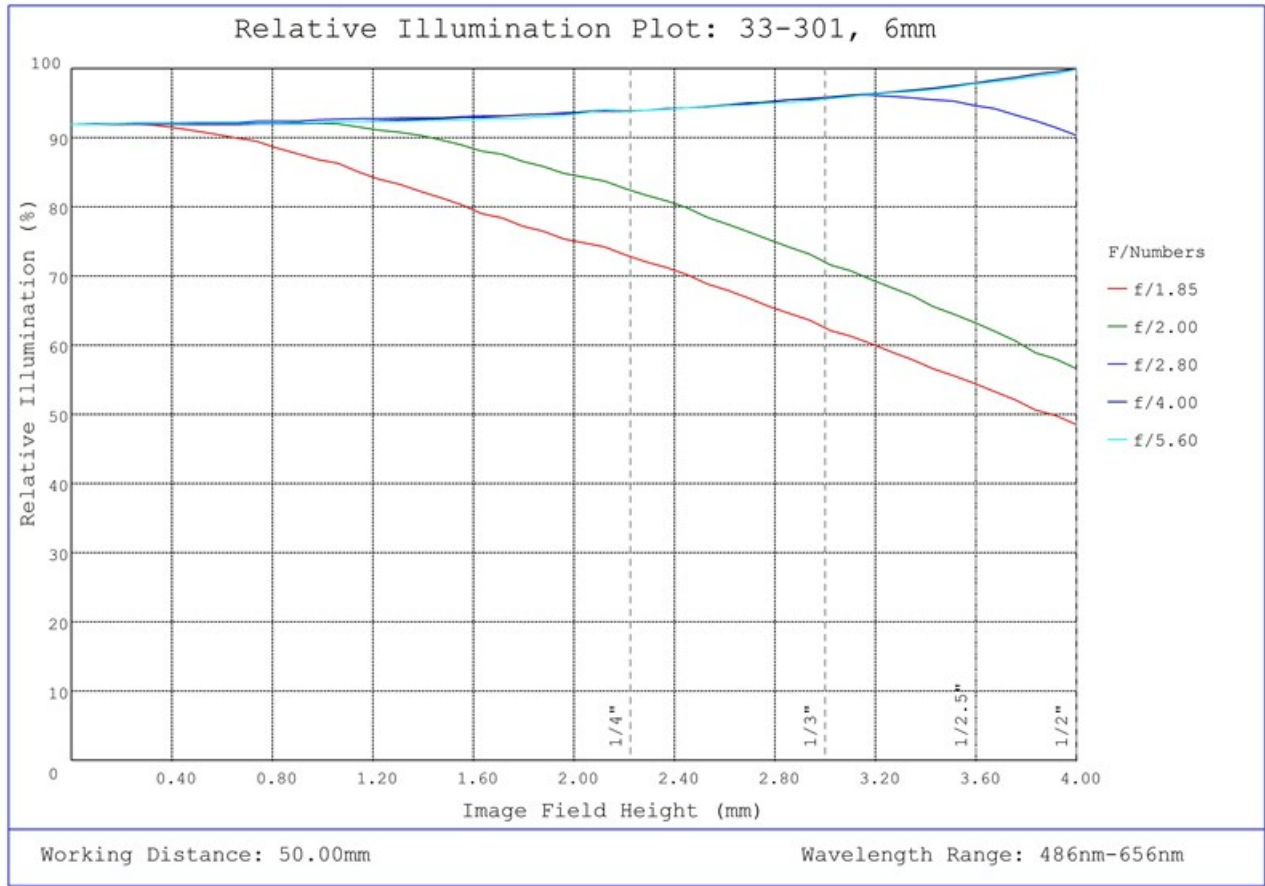

#33-301, 6mm UC Series Fixed Focal Length Lens, Relative Illumination Plot

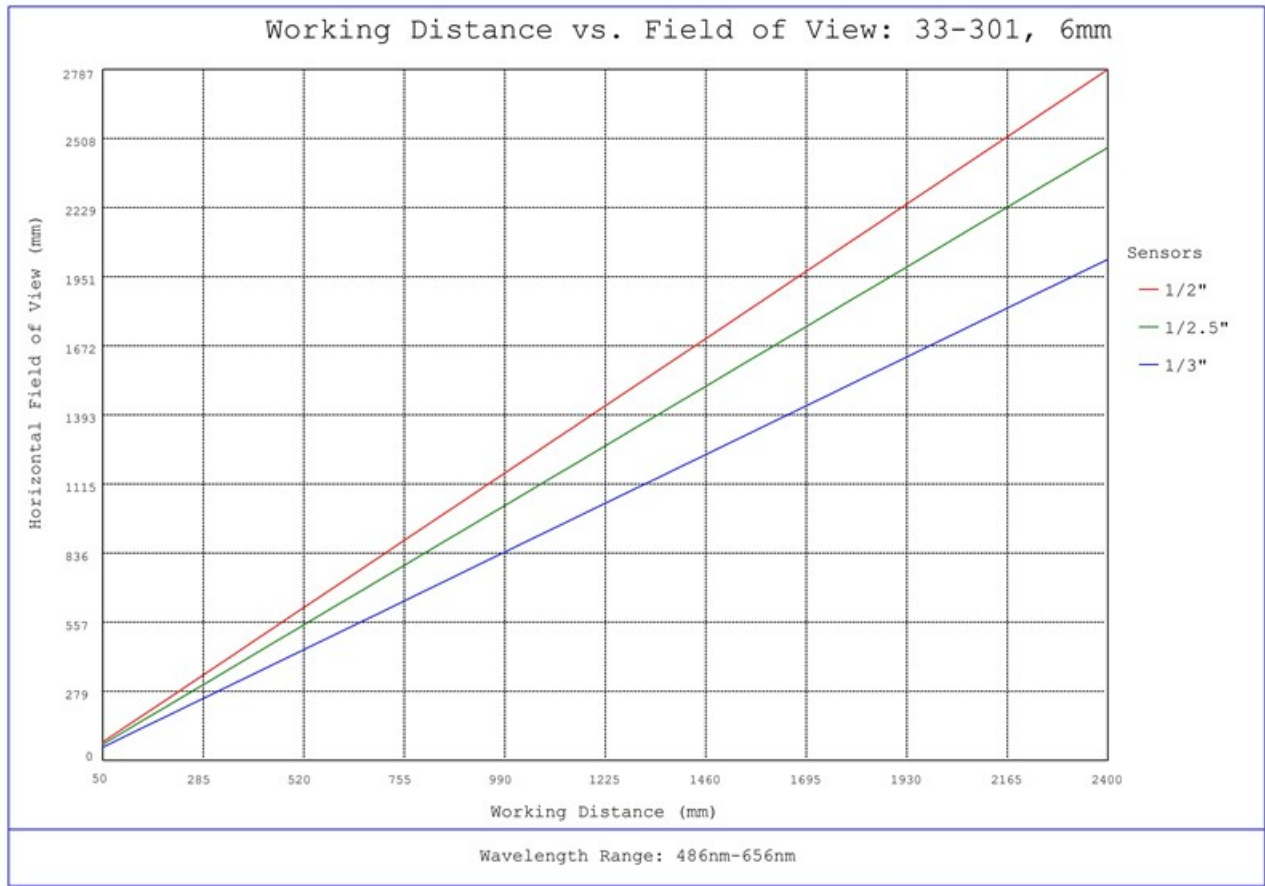

#33-301, 6mm UC Series Fixed Focal Length Lens, Working Distance versus Field of View Plot

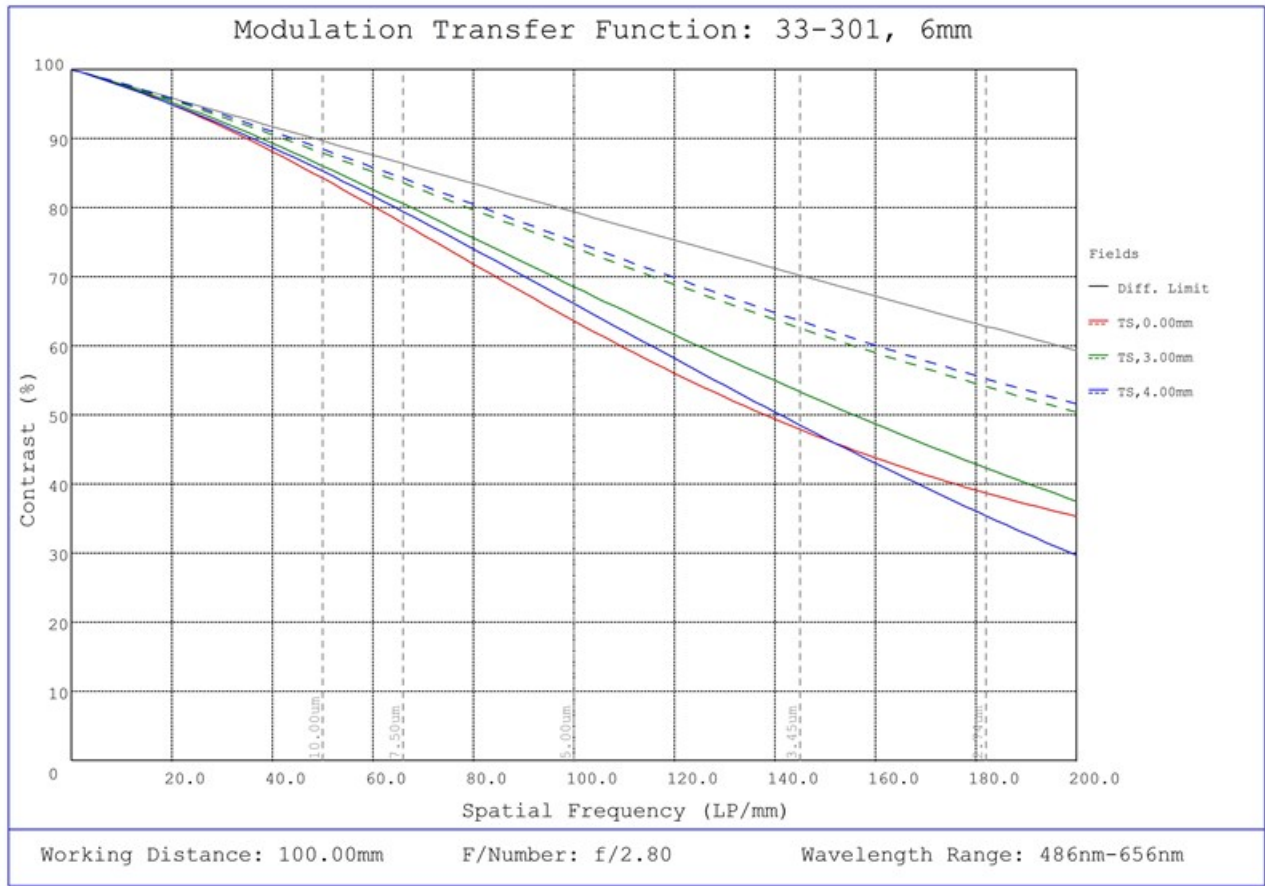

#33-301, 6mm UC Series Fixed Focal Length Lens, Modulated Transfer Function (MTF) Plot, 100mm Working Distance, f2.8



#33-301, 6mm UC Series Fixed Focal Length Lens, Depth of Field Plot, 100mm Working Distance, f2.8

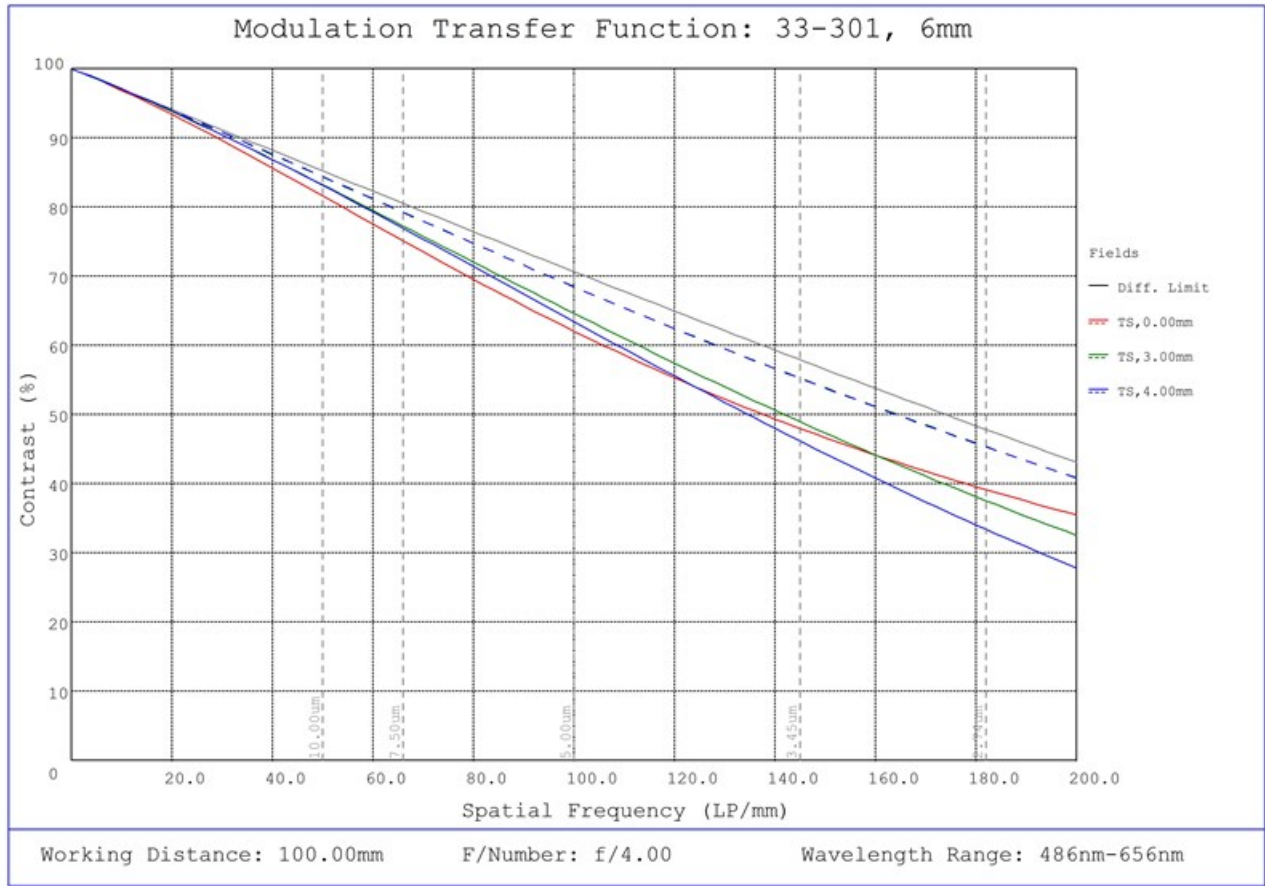

#33-301, 6mm UC Series Fixed Focal Length Lens, Modulated Transfer Function (MTF) Plot, 100mm Working Distance, f4



#33-301, 6mm UC Series Fixed Focal Length Lens, Depth of Field Plot, 100mm Working Distance, f4

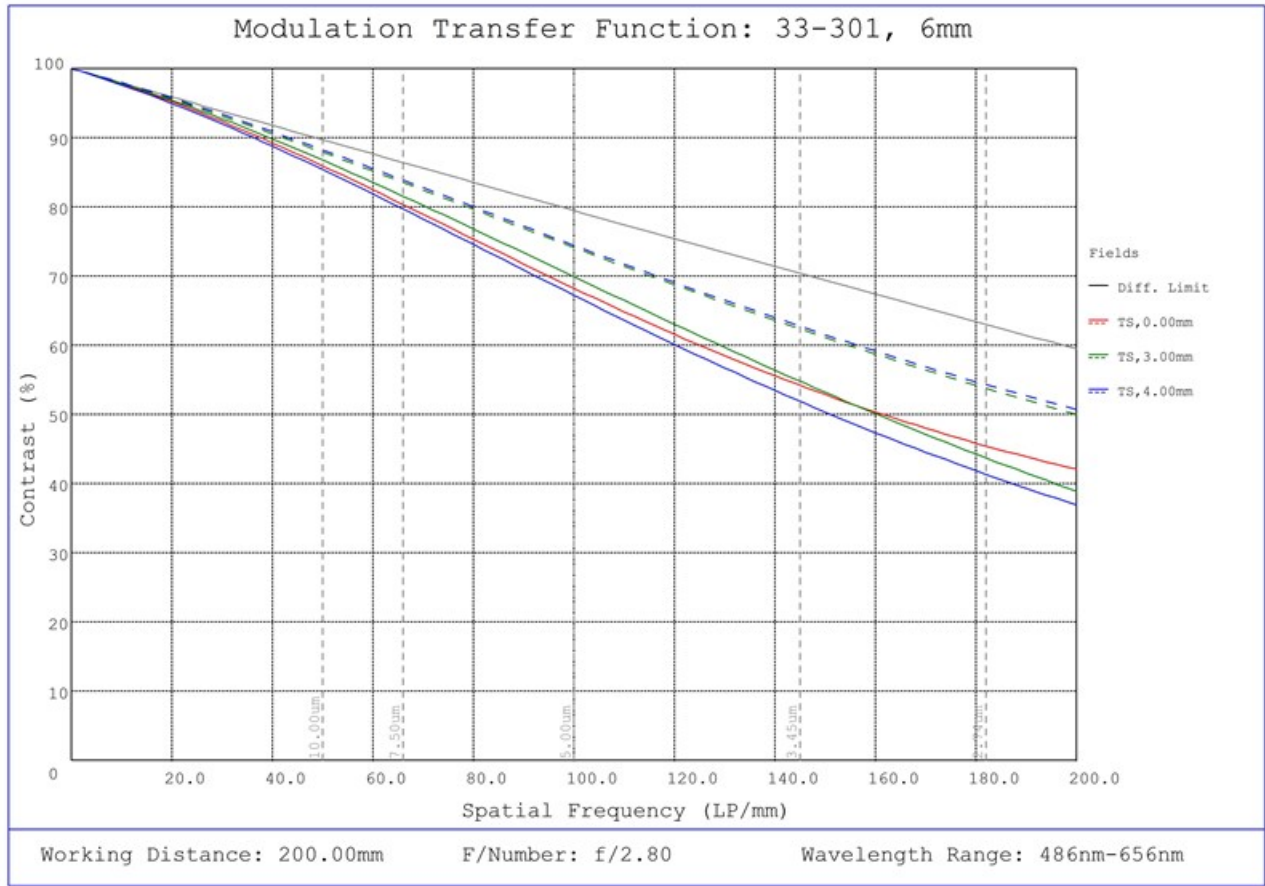

#33-301, 6mm UC Series Fixed Focal Length Lens, Modulated Transfer Function (MTF) Plot, 200mm Working Distance, f2.8



#33-301, 6mm UC Series Fixed Focal Length Lens, Depth of Field Plot, 200mm Working Distance, f2.8

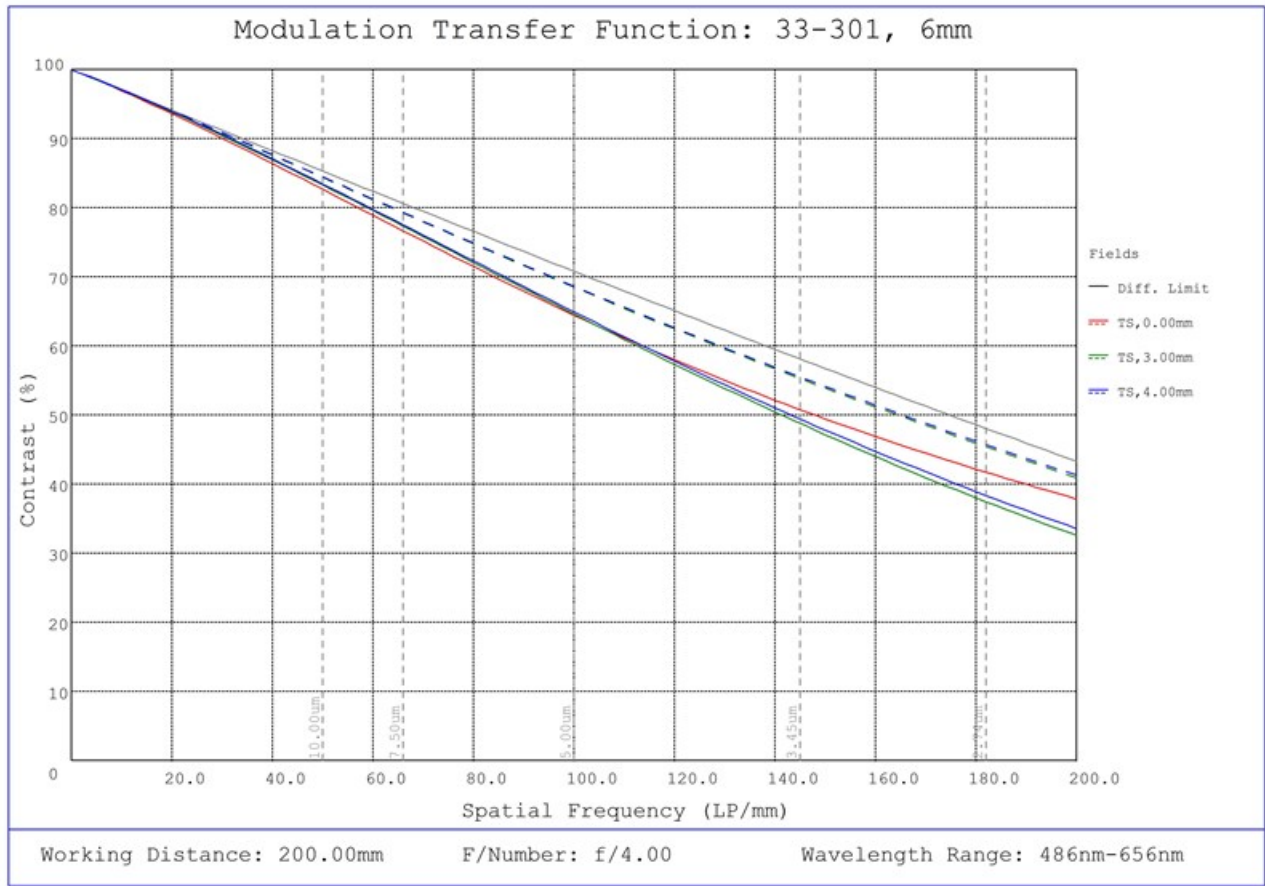

#33-301, 6mm UC Series Fixed Focal Length Lens, Modulated Transfer Function (MTF) Plot, 200mm Working Distance, f4



#33-301, 6mm UC Series Fixed Focal Length Lens, Depth of Field Plot, 200mm Working Distance, f4

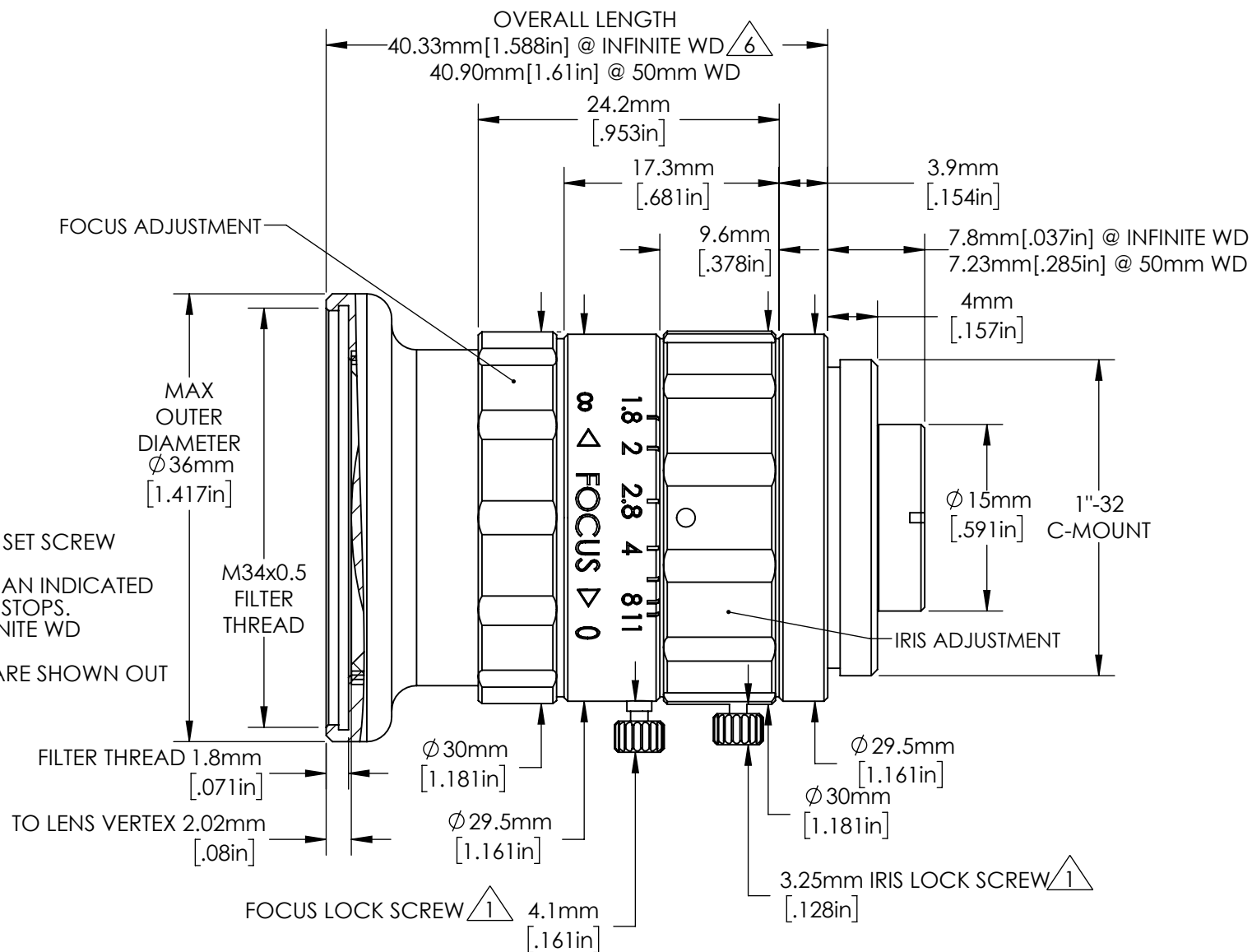

NOTES:

1. ALSO INCLUDES RECESSED SET SCREW OPTION.
2. LENS MAY MOVE MORE THAN INDICATED UNTIL IT REACHES BUILT-IN STOPS.
3. LENS IS SHOWN IN THE INFINITE WD POSITION.
4. IRIS AND FOCUS SCREWS ARE SHOWN OUT OF POSITION.



Edmund Optics®

**FOR INFORMATION ONLY:
 DO NOT MANUFACTURE
 PARTS TO THIS DRAWING**

SPECIFICATIONS SUBJECT TO CHANGE WITHOUT NOTICE. DIMENSIONS ARE FOR REFERENCE ONLY. FOR DETAILED SPECIFICATIONS, PLEASE REFER TO THE SPEC SHEET.

TITLE	6mm UC Series Fixed Focal Length Lens	
DWG NO	33301	
		SHEET 1 OF 1

Enable 3D View



June 09, 2023

To Whom It May Concern,

This document certifies that the product stated below has been reviewed as requested by Edmund Optics:

<i>Stock No.</i>	<i>Description</i>
33-301	6mm UC Series Fixed Focal Length Lens

This item is EU RoHS (2015/863/EU) compliant without the use of exemptions.

This certification means that:

- EO's suppliers have confirmed the material composition of this product.
- EO has implemented rigorous procedures to document this compliance.
- The information provided may, or may not, be based upon actual test data, or on information from our Vendors, Raw Material Suppliers or Subcontractors.

A handwritten signature in cursive script, appearing to read 'Jay Budd'.

Jay Budd, Director of Corporate Compliance

June 09, 2023

Edmund Optics Inc. - 101 E Gloucester Pike, Barrington, NJ 08007 | 1-800-363-1992 | Compliance@edmundoptics.com



June 09, 2023

To Whom It May Concern,

This document certifies that the product stated below has been reviewed as requested by Edmund Optics:

<i>Stock No.</i>	<i>Description</i>
33-301	6mm UC Series Fixed Focal Length Lens

This item does not contain any of the substances listed on the Reach SVHC list as of 16 July 2019 in quantities exceeding 0.1% weight by weight.

Please note the following:

- Entry 11 of Annex V of the REACH regulation as amended by regulation 987/2008, exempts “non-hazardous” glass components from registration.
- Items considered to be packing materials and which do not form part of, or are not required for the operation of, the product, are not considered to be within scope of this declaration.
- EO does not routinely analyze products for substances not purposely added or specified within the design specifications, drawings and assembly procedures.

This certification means that:

- EO's suppliers have confirmed the material composition of this product.
- EO has implemented rigorous procedures to document this compliance.
- The information provided may, or may not, be based upon actual test data, or on information from our Vendors, Raw Material Suppliers or Subcontractors.

A handwritten signature in cursive script that reads 'Jay Budd'.

Jay Budd, Director of Corporate Compliance

June 09, 2023

Edmund Optics Inc. - 101 E Gloucester Pike, Barrington, NJ 08007 | 1-800-363-1992 | Compliance@edmundoptics.com



June 09, 2023

<i>Stock No.</i>	<i>Description</i>
33-301	6mm UC Series Fixed Focal Length Lens

Edmund Optics certifies that all articles included in this shipment are in compliance with the terms and conditions of this order. The company also certifies that the articles included in this shipment are in accordance to all agreed upon specifications and quality assurance provisions. Please call 1-800-363-1992 should any questions arise from this shipment.

A handwritten signature in black ink, appearing to read 'Jeff Harvey'.

Jeff Harvey- EVP of Operations