

ML-M0822UR

ML-M-UR series



Drawing No. A23126

		Lens Type	CCTV Lens	
		Focus Position	Reference Magnification	M.O.D
		Magnification	0.016	0.071
(mm)		Focal Length	8.15	7.91
Fno		Fno	2.20 16.00	
NA		Numerical Aperture	-	-
WD/OD (mm)		Working/Object Distance	500.0 / 504.0	100.0 / 104.0
O/I (mm)		Object to Image Distance	555.84	155.29
(mm)		Mechanical Tube Length	37.20 37.80	
(mm)		Lens Back	11.87	11.87
(mm)		DOF @PCoC 0.04mm	720.153	36.461
(μ m)		Resolution @ $\lambda=550$ nm	-	-
/ (mm)		Front/Rear Principal Position	16.19 / 3.61	16.10 / 3.45
/ (mm)		Entrance/Exit Pupil Position	10.58 / -14.32	10.62 / -14.32
/ (mm)		Entrance/Exit Pupil Diameter	3.72 / 11.91	3.67 / 11.91
(deg.) H x V		Angle Of View	58.41 x 44.84	59.15 x 45.46
TV (%)		TV Distortion	-1.802	-1.846
(%)		Relative Illumination	27.94	27.89
(g)		Weight	60	
		Mount	C mount	
(mm)		Image Circle	11	
		Largest Compatible Camera	2/3Inch	

ML-M0822UR

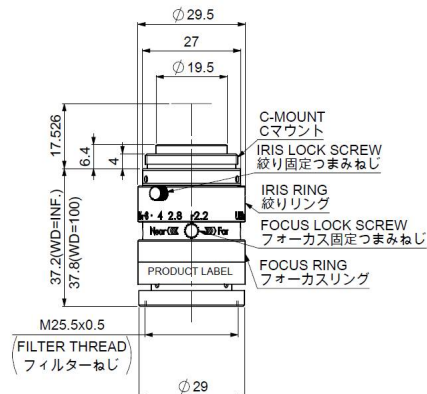

WD=500.0mm Fno2.8

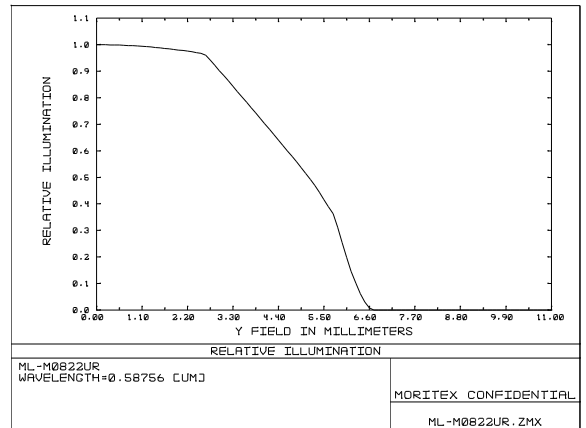
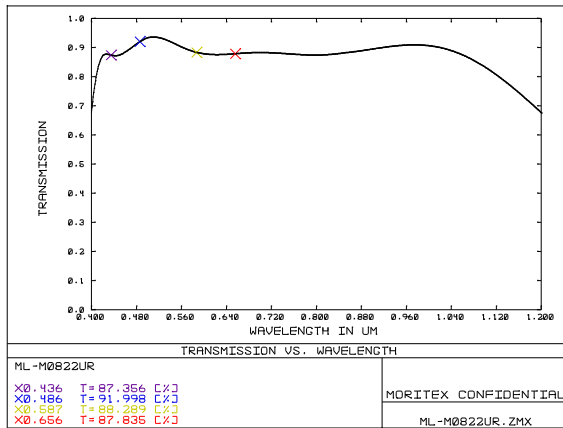
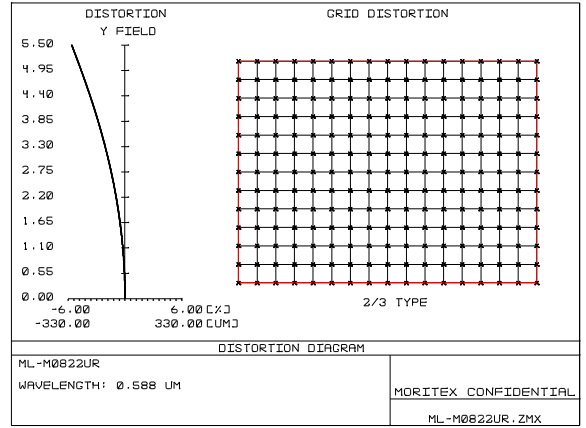
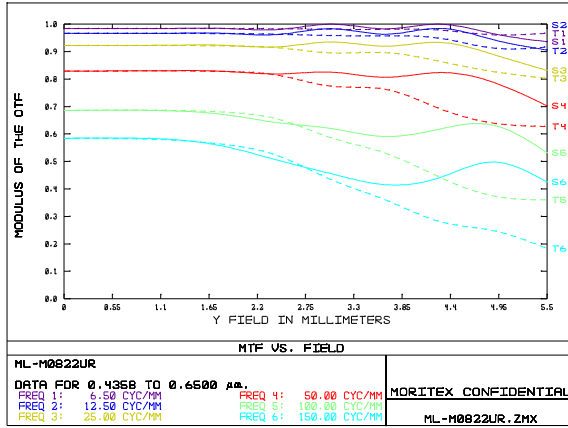

The content is subject to change at any time without notification.

株式会社 **モリテックス** MORITEX Corporation

Technology center Lens design & Development technology

TEL +81 (0)48-218-2536 moritex.mvs@moritex.com

FAX +81 (0)48-462-6713 www.moritex.com



WD=300.0mm Fno2.8

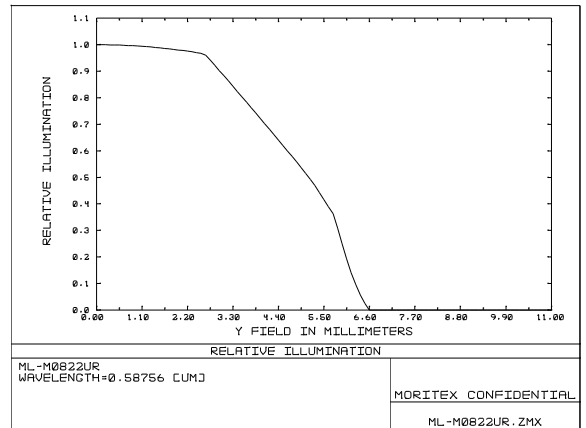
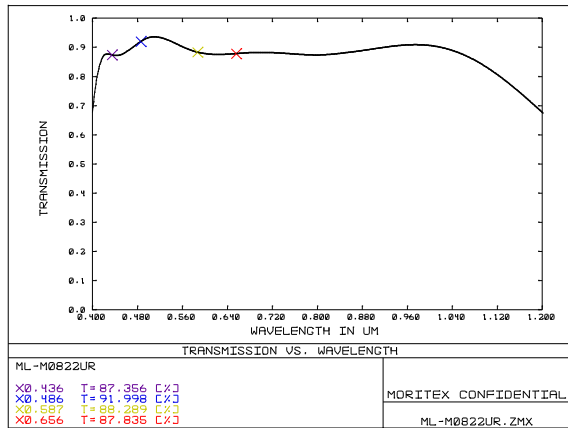
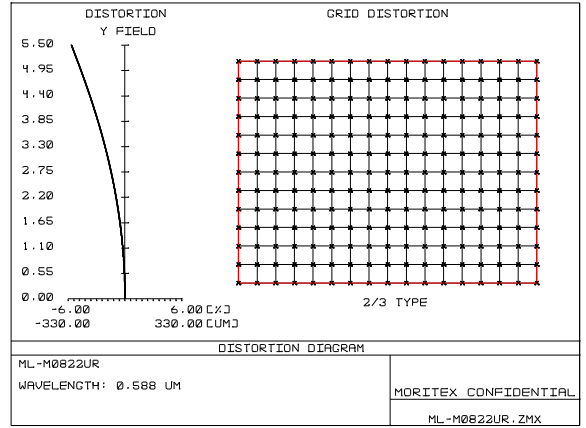
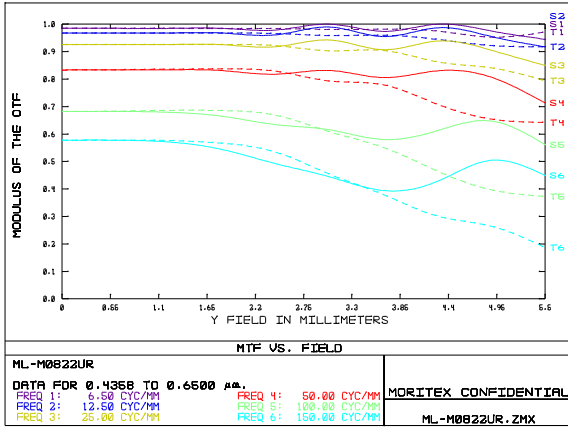

The content is subject to change at any time without notification.

株式会社 モリテックス MORITEX Corporation

Technology center Lens design & Development technology
 TEL +81 (0)48-218-2536 moritex.mvs@moritex.com
 FAX +81 (0)48-462-6713 www.moritex.com



WD=100.0mm Fno2.8

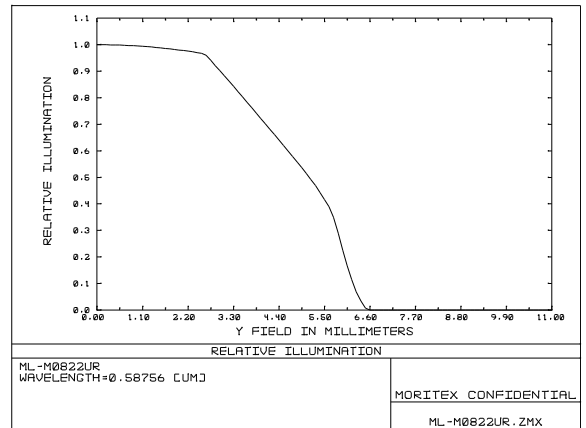
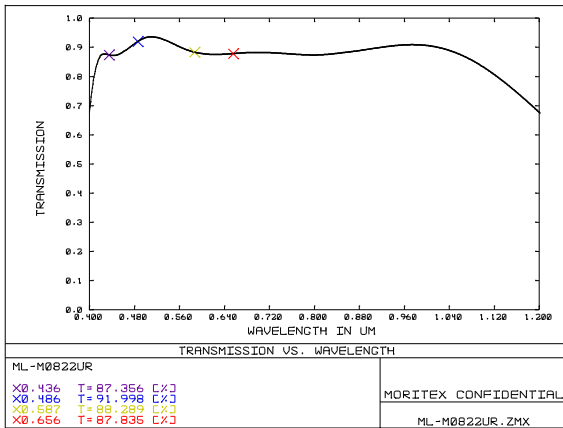
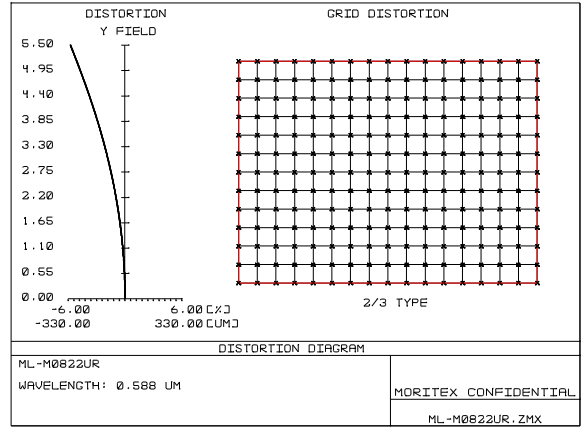
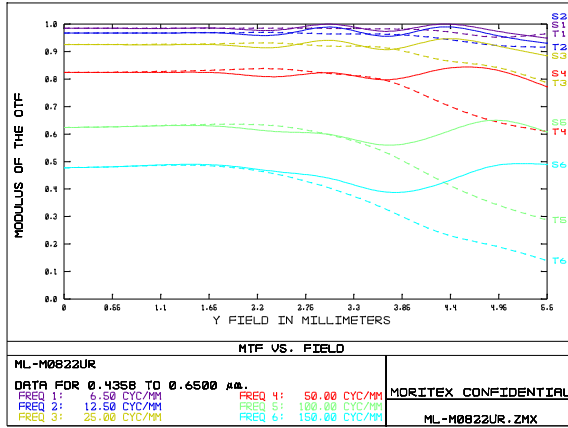

The content is subject to change at any time without notification.

株式会社 モリテックス MORITEX Corporation

Technology center Lens design & Development technology
 TEL +81 (0)48-218-2536 moritex.mvs@moritex.com
 FAX +81 (0)48-462-6713 www.moritex.com

