

PRODUCT SPECIFICATION:

A74-1218[2]

SPECIFICATION REVISION:

03	(Chua 150723)	Update Details
04	(Chua 150723)	Change Template
05	(Chua 150810)	Change Template

CONSISTING OF DOCUMENTS:

QTY	QTY UNIT	SPECIFICATION
1	PC	P74-1218[2] rev04
1	PC	LPR 0000 rev03
1	PC	ETR 0901 rev01
1	PC	ATR 0000 rev02



DRAWING REF: **P74-1218**
 DRAWING REF: USB 3.0 Industrial Assembly (A+ series)
 REVISION: 01 (Chua 150617) Update Details
 02 (Chua 150812) Add Elec. Test
 03 (Chua 160219) Update Specification
 04 (MS 160422) -T, & Pad Print

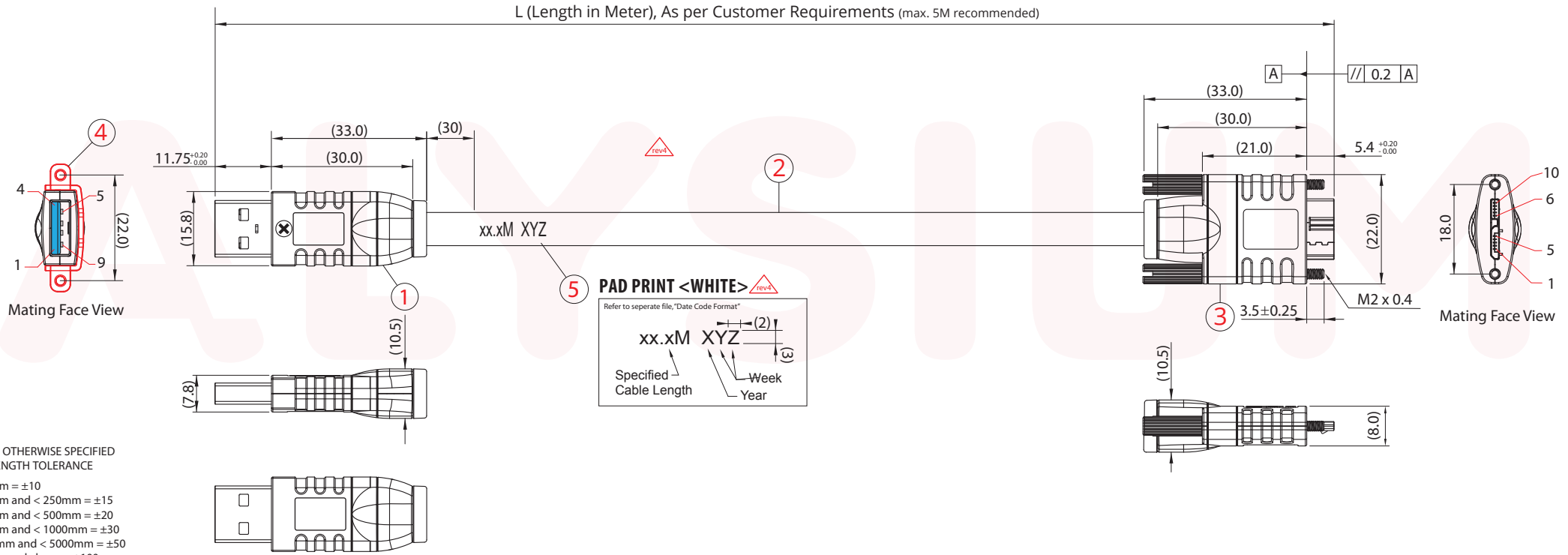

UNLESS OTHERWISE SPECIFIED
 ASSY LENGTH TOLERANCE

< 150mm	= ±10
≥ 150mm and < 250mm	= ±15
≥ 250mm and < 500mm	= ±20
≥ 500mm and < 1000mm	= ±30
≥ 1000mm and < 5000mm	= ±50
5000mm and above	= ±100

RoHS COMPLIANT

This document is the property of Alysium-Tech. It must not be copied or otherwise disclosed without prior written consent



BILL OF MATERIALS

Item	Description
1	A+ USB A 3.0 (OD5.8 Die Cast Threaded) Die Cast Shell incl. M2.6x2.5 screw (to be disposed, when bracket is applied)
2	A86-1684(T), [OD=5.8mm] <BLK> (rev4) E357566-ALY-T UL2725 2STP#28 + 1P#28 + 2C#24
3	A+ USB MicB 3.0 sl (OD5.8 Die Cast) Die Cast Shell
4	USB A 3.0 (Die Cast) sl Bracket (Refer to Accessories Details)
5	White Pad Print on Cable (rev4)

TEST SPECIFICATION

Electrical Test (Continuity, Insulation Resistance, Conductance Test)	
For Assembly Length < 20m	For Assembly Length ≥ 20m
1) Voltage = 300VDC,	1) Voltage = 500VDC,
2) Insulation Resistance = 20MΩ	2) Insulation Resistance = 20MΩ
3) Conductance = 3Ω	3) Conductance = 5Ω

WIRING DIAGRAM

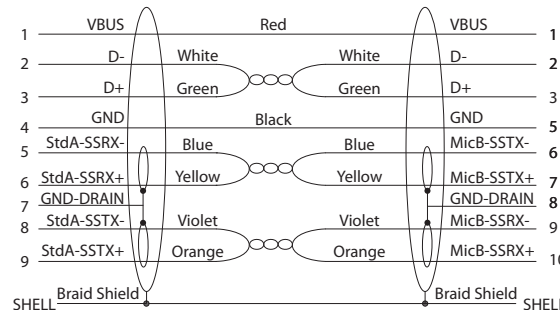

ACCESSORIES DETAILS

This Assembly/ Item 4 inclusive of accessories as per below shown:
 A) Metal Sheet Bracket for USB A 3.0 (1pc)
 B) M2 Thumb Screw (2pcs)
 C) M2.5x3.0 Flat Head Screw (Pre-Installed in Metal Sheet Bracket) (1pc)

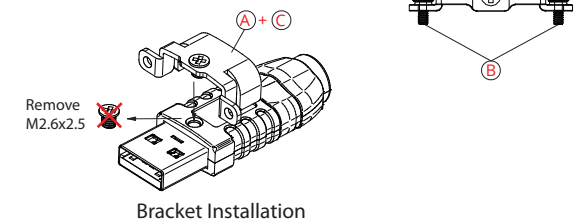



DRAWING REF: **LPR 0000**

DRAWING REF: Packaging Detail for USB Assembly (A+ Series)

REVISION:	00	(WON 150612)	Initial Issue
	01	(Chua 150616)	Update Details
	02	(Chua 151012)	Change to LPR 0000
	03	(MS 160422)	Change Template

Hot Sealed PE Bag Packaging

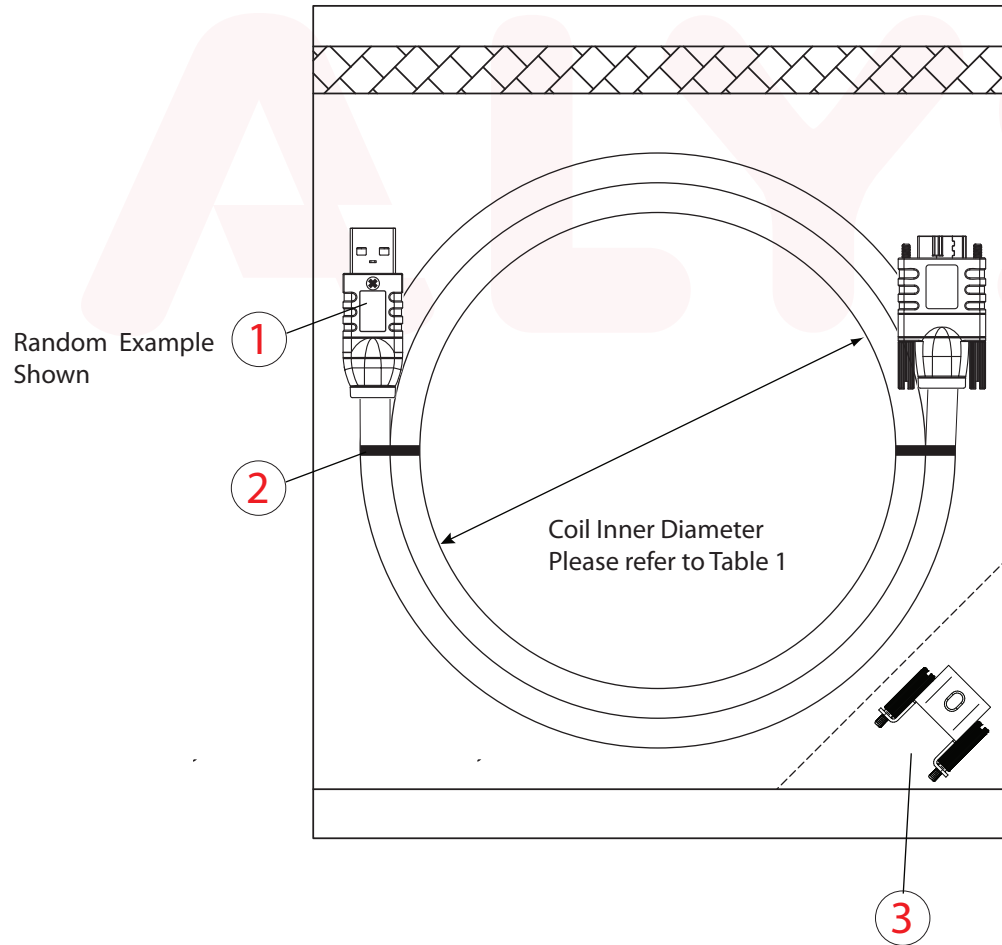

Packaging Contains

- | | |
|--|-------------------------------------|
| 1) Basic Assembly | 1pc |
| 2) Magic Tie / Cable Tie | 2pcs |
| ** 3) Accesories | 1Set (Subject to type of connector) |
| --> Metal Sheet Bracket | 1pc |
| --> Thumb Screw (M2) | 2pcs |
| ** Available for USB A 2.0/3.0 and USB B 2.0*3.0 | |

Table 1 : Assembly Coiling Inner Diameter
(Unless Otherwise)Specified

Type of Cable / Cable Jacket OD	Coil ID (mm)
General	150
MCD-USB-211	250

Electrical Test Criteria

- 1) Open/Short circuit
- 2) Intermittent
- 3) Insulation Resistance

Hi Pot Tester Model

CT-8681N (ATPN : ETE 0900)

Measurement Parameters

Voltage = 300VDC,

Insulation Resistance > 20M Ohm,

Time = 0.1s

Sampling size

100% Check

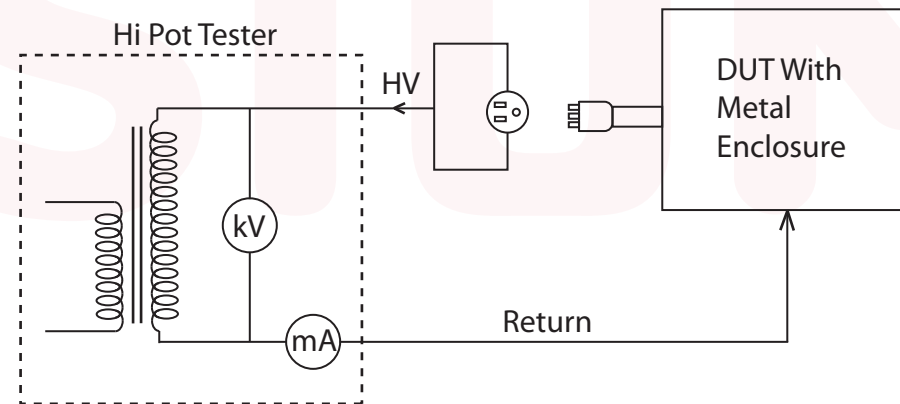

Simulated Line Leakage Diagram

Test Equipment	Test Procedure	Acceptable Pass Criteria
<p>PassMark USB 3.0 Loop Back Plug Tester Model: PMUSB03</p> 	<p>No errors displayed or counted in the interface.</p> <p>Speed should always be 5Gb/s and the voltage should be around 5V with a tolerance of ± 50 mV.</p> <p>Test duration must be set to 0.5 min.</p>	<p>The superspeed values for READ and WRITE speed should be above 2000Mb/s or 200MB/s.</p> <p>When the assemblies are connected with the loopback device with the CPU, the interface of software will detect super speed and can run up to 30s cycle time. Only then the assemblies are categorized as PASS.</p> <p>But, if the interface of the software only detects high speed, then the assemblies are automatically categorized as FAIL.</p>

Note:

The above test is applicable only for USB 3 cable assembly USB A 3.0 TO USB Micro B 3.0 only.

Sampling Size:

100% Check