



TM-1325 Series Progressive Scan Shutter Cameras

Operation Manual

Notice

The material contained in this manual consists of information that is proprietary to JAI PULNiX Inc., and may only be used by the purchasers of the product. JAI PULNiX Inc. makes no warranty for the use of its product and assumes no responsibility for any errors which may appear or for damages resulting from the use of the information contained herein. JAI PULNiX Inc. reserves the right to make changes without notice.

Microsoft, Windows 98, Windows 95, Windows NT, Windows XP, and Windows Explorer are either registered trademarks or trademarks of Microsoft Corporation in the United States and/or other countries.

Warranty

Please contact your factory representative for warranty information.

Certifications

CE Compliance

The TM-1325 series camera has been certified to conform to the requirements of Council Directive 89/336/EC for electromagnetic compatibility and to comply with the following European Standards:

Immunity: EN50082-2/1997

Emissions: CISPR22: 1997/EN55011: 1998 Class B

All JAI PULNiX products bearing the CE mark have been declared to be in conformance with the applicable EEC Council Directives. However, certain factory-installed options or customer-requested modifications may compromise electromagnetic compatibility and affect CE compliance. Please note that the use of interconnect cables that are not properly grounded and shielded may affect CE compliance.

Contact JAI PULNiX's Applications Engineering Department for further information regarding CE compliance.

FCC

This equipment has been tested and found to comply with the limits for a Class A digital device, pursuant to Part 15 of the FCC Rules. These limits are designed to provide reasonable protection against harmful interference when the equipment is operated in a commercial environment. This equipment generates, uses and can radiate radio frequency energy and, if not installed and used in accordance with the instruction manual, may cause harmful interference to radio communications. Operation of this equipment in a residential area may cause harmful interference, in which case the user will be required to correct the interference at his own expense.

WARNING

Changes or modifications to this unit not expressly approved by the party responsible for FCC compliance could void the user's authority to operate the equipment.

TM-1325 Series Operation Manual

JAI PULNiX Inc.

1330 Orleans Drive

Sunnyvale, CA 94089

Tel:(408) 747-0300

Tel:(800) 445-5444

Fax:(408) 747-0880

E-mail: pulnix@pulnix.com

www.jaipulnix.com



1	Introduction	1
1.1	Product Description	1
1.2	Features	2
1.3	Functional Options	3
1.4	System Configuration	4
2	Installation	5
2.1	Getting Started	5
2.1.1	Unpacking Instructions	5
2.1.2	Components List	5
2.1.3	Accessories and Options	5
2.2	Camera Setup	6
2.2.1	Heat Dissipation	6
2.2.2	Connector Pin Configurations	6
2.2.3	Shutter Speed Control Dial (TM-1325 only)	9
2.2.4	RS-232 Communication Cable (TM-1325 only)	9
2.2.5	Digital Output Cable (TM-1325 only)	10
2.2.6	Camera Link Cable (TM-1325CL only)	11
2.2.7	Power Supplies and Power Cable Setup	11
2.2.8	Attaching the Analog Video Output	13
2.2.9	Attaching the Camera Lens	13
3	Operation	14
3.1	Camera Rear Panel (TM-1325)	14
3.1.1	Up/Down Switch	14
3.1.2	Digital Output Connector	14
3.1.3	Analog Output Connector	14
3.1.4	Power, RS-232, and External Sync Connector	14
3.1.5	Shutter Speed Control Switch	14
3.1.6	Mode Selection Switch	14
3.2	Camera Rear Panel (TM-1325CL)	16
3.2.1	Digital Output Connector (Camera Link Connector)	16
3.2.2	Analog Output Connector	16
3.2.3	Power and External Sync Connector	16
3.3	Progressive Scanning	17
3.4	Electronic Shutter	17
3.5	Integration	18
3.6	Asynchronous Reset	18
3.6.1	External VINIT With Pulse Width	18
3.6.2	Internal Shutter Speed Control	19
3.7	Dynamic Range Control	20
3.7.1	Programmable Look-Up Table (LUT) and Knee Control	20
3.8	Scan Modes	21
3.8.1	Full Progressive Scan	21
3.8.2	Partial Scan	21
3.9	External Sync	21
3.10	Camera Timing Charts	22

3.11 Serial Communication Kit CS-232C (not required for "CL" version)	26
4 Troubleshooting	27
4.1 Problems and Solutions	27
4.1.1 Symptom: No Video	27
4.1.2 Symptom: Dark Video	27
4.1.3 Symptom: Non-Synchronized Video	27
4.2 Troubleshooting Flowchart	28
4.3 Troubleshooting Flowchart 2	29
4.4 Information and Support Resources	30
5 Appendix	31
5.1 Specifications	31
5.1.1 Physical Dimensions	33

FIGURE 1. TM-1325 System Configuration4

FIGURE 2. TM-1325CL System Configuration4

FIGURE 3. 12-Pin Connector on Rear Panel of Camera6

FIGURE 4. 31-Pin Digital Connector on Rear Panel of Camera (TM-1325 only)7

FIGURE 5. Serial Communication Cable RS-232B-129

FIGURE 6. Pinout Configuration for Digital Output Cable10

FIGURE 7. 12P-02S Interface Cable (optional).....12

FIGURE 8. Pulse Width Async Shutter Timing19

FIGURE 9. Physical Dimensions (TM-1325)33

FIGURE 10. Physical Dimensions (TM-1325CL)33

TABLE 1. 12-Pin Connector (TM-1325)6

TABLE 2. 12-Pin Connector (TM-1325CL)6

TABLE 3. 31-Pin Connector (MP211-031-113-4300)7

TABLE 4. Connector Pinout Configurations (10226-6212 VC)8

TABLE 5. Shutter Speed Control Dial9

TABLE 6. Mode Selection Switch15

TABLE 7. TM-1325 and TM-1325CL Product Specifications Table31

TM-1325 Series Progressive Scan Shutter Cameras

Operation Manual

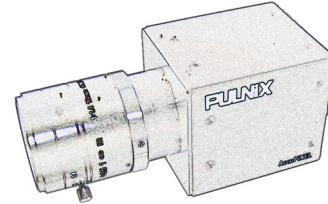

1 Introduction

1.1 Product Description

The PULNiX TM-1325 and TM-1325CL are high-resolution, high-speed monochrome progressive scan CCD cameras.¹ The interline-type CCD permits full vertical and horizontal resolution of very high speed shutter images and applications. The electronic shutter, which has speeds to 1/16,000 sec., can be reset asynchronously by external pulse control. Four frame rates are available: 15, 30, 58, and 100 fps. On-chip micro lenses provide increased sensitivity.

The TM-1325 has a full dynamic range control function, which can be set at externally selectable look-up-table (LUT) knee slopes to convert 10-bit input to 8-bit output, thereby optimizing the CCD's full dynamic range in the normal output signal range. The camera has an 8-bit, RS-644 digital signal output for interfacing with external image-processing systems. All the key functions are externally controlled via RS-232C. The TM-1325CL model has a Camera Link output. Its key functions are externally controlled via differential serial communication of Camera Link.

Applications for the TM-1325 include machine vision, medical imaging, intelligent transportation systems, high-definition graphics, on-line inspection, gauging, character reading, archiving, and high-security surveillance.

1. Unless specifically mentioned, all information in this manual is relevant to both the TM- 1325 and the TM-1325CL cameras.

1.2 Features

- **Miniaturized and lightweight**

The printed circuit boards in the TM-1325 have been arranged with a new design philosophy in mind. This creates modular electronics for the camera, giving it flexibility. In addition, the use of miniature solid-state components results in a compact, lightweight camera that is 44mm x 44mm x 64mm in dimensions, and weighs only 140 grams.

- **Imager**

The TM-1325 uses a progressive scan interline transfer CCD that has the following features:

- Resolution of 1392 x 1040 active pixels for excellent image quality.
- 6.45 x 6.45 μm square pixels for precise dimensional measurement.
- High-speed electronic shutter capability for high dynamic resolution of moving objects and electronic iris control that eliminates the need for a mechanical shutter.
- Progressive scan CCD eliminates interlace deterioration of image and increases ease of computer interface.
- High sensitivity and low noise at fast scanning. The CCD can drive faster than 55 MHz pixel clock rate and has an excellent S/N ratio that is greater than 50dB.
- The CCD for the TM-1325 has built-in microlenses.

- **Electronic shutter**

The TM-1325 has a substrate drain-type shutter mechanism which provides superb pictures at various speeds without smearing. A built-in manual shutter speed control selects the electronic shutter rate of 1/60 (non-async mode only), 1/125, 1/250, 1/500, 1/1,000, 1/2,000, 1/4,000, 1/8,000, or 1/16,000 second.

With VINIT high (5V), the CCD keeps discharging. With a negative pulse to VINIT, the camera resets and purges the charge momentarily. Then it starts integrating for the period of shutter control set by either an external pulse width or internal shutter control. Progressive scanning permits a full 1040 lines of vertical resolution, as compared to a conventional CCD camera which captures only half the vertical lines per shutter.

- **Asynchronous reset**

The TM-1325's asynchronous reset is flexible and accepts external horizontal drive (HD) for phase locking. When the VINIT pulse is applied, it resets the camera's scanning and purging of the CCD. There are two modes to control the asynchronous reset and shutter speed:

- **External VINIT with pulse width.** The duration between pulse edges controls the shutter speed externally.
- **Internal shutter control mode.** The speed control varies from 1/125 to 1/16,000 sec. The video signal starts with internal V reset timing related to shutter speed.

- **Output**

The TM-1325 has an 8-bit RS-644 (LVDS) digital output for interfacing with external image-processing systems. The TM-1325 camera is also available with RS-422 digital output as an option (OP-93). The TM-1325CL has a Camera Link output. The analog output is 1.0 Vp-p composite video (75 ohms).

- **Asynchronous image capturing**

The TM-1325 captures async reset images and provides single-shot video output with single FDV. This makes it simpler for an ordinary frame grabber to capture the async reset images.

- **Integration**

The TM-1325 is capable of capturing high-resolution integration images. Its CCD imager can be exposed for longer than the normal scan timing of 1/30 sec. This integration feature provides extra sensitivity for applications in dark environments. The progressive scan imager permits a full frame of resolution in non-interlace format. Integration is achieved by controlling the #11 pin of the 12-pin connector to low (GND) or pulse width control VINIT to pin #6 of the 12-pin connector up to 1 second.

- **Warranty**

Contact your factory representative for warranty information.

1.3 Functional Options

- Back-focus adjustment (OP97).
- Differential input, VINIT (OP89-3).
- Differential input, VD (OP89-4).
- RS-422 (digital) output for the TM-1325 (93).

1.4 System Configuration

FIGURE 1. TM-1325 System Configuration

Figure 1 below presents a typical system configuration for the TM-1325 camera.

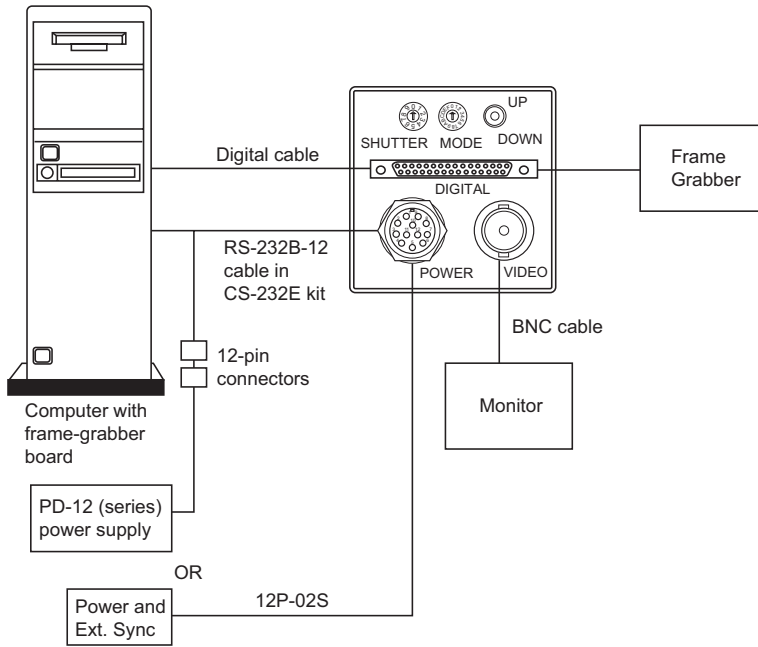
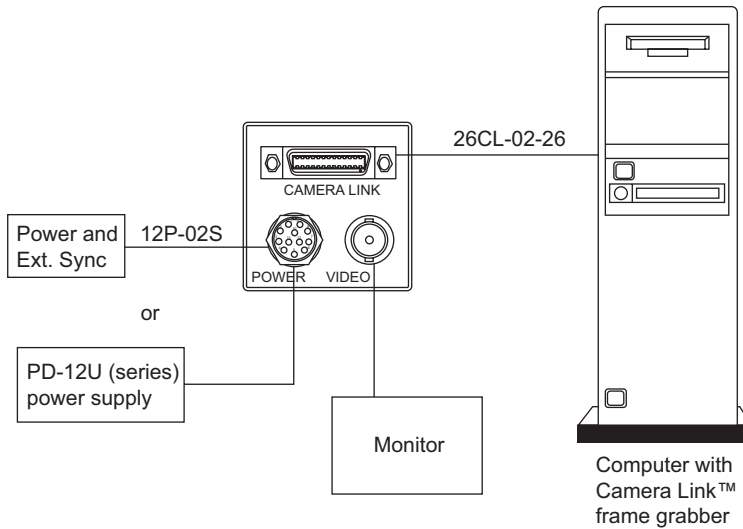

FIGURE 2. TM-1325CL System Configuration

Figure 2 below presents a typical system configuration for the TM-1325CL camera.



*PULNiX PVM-942 or PVM-1242 monitor can be used with camera in two-row binning mode.

2 Installation

The following instructions are provided to help you to set up your camera quickly and easily. We suggest that you read through these instructions before you unpack and set up your camera system.

2.1 Getting Started

2.1.1 Unpacking Instructions

We recommend that you save the original packing cartons for the cameras and accessories in case you need to return or exchange an item.

We also recommend that you bench-test any equipment being sent to another location for field installation to assure that everything is fully operational as a system.

2.1.2 Components List

Please begin by checking your order against the Components List shown below to assure that you have received everything as ordered, and that nothing has been overlooked in the packing materials. If any item is missing, please contact your JAI PULNiX representative immediately.

- TM-1325 camera
- TM-1325 operation manual (if ordered)
- Camera-control software manual
- Camera-control software

2.1.3 Accessories and Options

Following is a list of additional accessories and options that may be required for your application. Please check with your PULNiX representative before you install your camera to determine what you might need.

- Digital output cable (not required for “CL” version)
 - 30DG-02 (for standard model only)
 - 26CL-02-26 (for Camera Link model only)
- Serial Communication Kit CS-232E (not required for “CL” version)

Note: For CL models, the control software is included and serial communication is through the Camera Link cable. No additional accessories are required.

- PD-12UUP series power supply
- 12P-02S power cable

2.2 Camera Setup

2.2.1 Heat Dissipation

The TM-1325 camera is a compact 1.3K x 1K camera. Since all the electronics have been packed in a compact package, the outer case of the camera gets hot due to heat dissipation. JAI PULNiX recommends the following procedure for optimal performance of the camera:

1. Mount the camera on a large heat sink (camera bracket) made out of conductive material like aluminum.
2. Make sure the flow of heat from the camera case to the bracket is not blocked by a non-conducting material like plastic.
3. Make sure the camera has enough open space around it to facilitate the free flow of air.
4. If possible, use a cooling fan to set up a positive air flow around the camera.

2.2.2 Connector Pin Configurations

2.2.2 (a) 12-Pin Connector (TM-1325)

FIGURE 3. 12-Pin Connector on Rear Panel of Camera

The TM-1325 has a 12-pin Hirose connector for power input, serial communication, and signal integration. Pin #1 is Ground and Pin #2 is +12V DC. Other pins handle a number of input and output functions, as shown in Table 1 below.

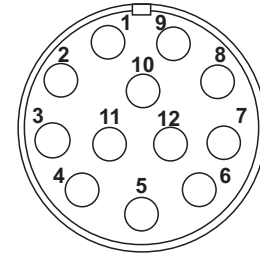

TABLE 1. 12-Pin Connector (TM-1325)

Pin	Description	Pin	Description
1	GND (power)	7	VD In
2	+12V DC	8	Reserved
3	GND (analog)	9	HD In
4	Video Out	10	RXD (RS-232)
5	GND (digital)	11	Integration Control/ROI
6	VINIT In	12	TXD (RS-232)

2.2.2 (b) 12-Pin Connector (TM-1325CL)

The TM-1325CL has a 12-pin Hirose connector for power input and signal integration. Pin #1 is Ground and pin #2 is +12V DC. The pinout table is shown below. For the TM-1325CL, serial communication camera control is done via the MDR26 Camera Link connector on the rear panel of the camera.

TABLE 2. 12-Pin Connector (TM-1325CL)

Pin	Description	Pin	Description
1	GND (power)	7	VD in
2	+12V DC	8	Reserved
3	GND (analog)	9	HD in

TABLE 2. 12-Pin Connector (TM-1325CL) (Continued)

Pin	Description	Pin	Description
4	Video out	10	N/C
5	GND (digital)	11	Integration Control/ROI
6	VINIT in	12	N/C

2.2.2 (c) Digital Output Connector (TM-1325 only)

The TM-1325 has a 31-pin AirBorn connector (MP211-031-113-4300) on the rear panel to output 8-bit, RS-644 video data. The connector pin-out is shown in the figure below.

FIGURE 4. 31-Pin Digital Connector on Rear Panel of Camera (TM-1325 only)

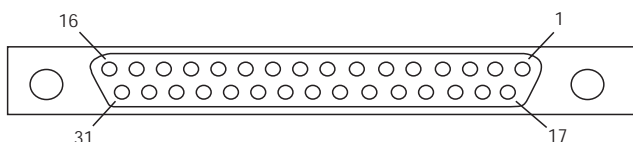

Note: CLK: data clock, LDV: Line Data Valid, FDV: Frame Data Valid, INTEG: Integration control, EXT CLK: external pixel clock, []: Differential input option.

TABLE 3. 31-Pin Connector (MP211-031-113-4300)

Pin #	Description	I/O	Pin #	Description	I/O
1	CLK+	Out	17	CLK-	Out
2	LDV+	Out	18	LDV-	Out
3	FDV+	Out	19	FDV-	Out
4	GND		20	VINIT (TTL) [Integ (TTL)]	In In
5	EXT HD (TTL) [EXT CLK+]	In	21	EXT VD (TTL) [EXT CLK-]	In
6	INTEG (TTL) [HD+]	In In	22	N/C [HD-]	In
7	N/C [VINIT+/(VD+)]	In	23	GND [VINIT-/(VD-)]	In
8	D0+	Out	24	D0-	Out
9	D1+	Out	25	D1-	Out
10	D2+	Out	26	D2-	Out
11	D3+	Out	27	D3-	Out
12	D4+	Out	28	D4-	Out
13	D5+	Out	29	D5-	Out
14	D6+	Out	30	D6-	Out
15	D7+	Out	31	D7-	Out
16	GND				

2.2.2 (d) Camera Link Connector

The TM-1325CL has a 26-pin MDR26 connector (3M part number 10226-6212VC) on the rear panel to output Camera Link data. The connector pin-out is shown in Table 4 below.

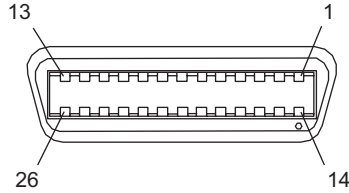

TABLE 4. Connector Pinout Configurations (10226-6212 VC)¹

Camera Link Connector MDR 26-pin Connector 10226-6212VC					
Pin #	Description	I/O	Pin #	Description	I/O
1	GND		14	GND	(Shield)
2	Tx OUT 0-	Out	15	Tx OUT 0+	Out
3	Tx OUT 1-	Out	16	Tx OUT 1+	Out
4	Tx OUT 2-	Out	17	Tx OUT 2+	Out
5	Tx CLK OUT -	Out	18	Tx CLK OUT+	Out
6	Tx OUT 3-	Out	19	Tx OUT 3+	Out
7	SerTC+	In	20	SerTC-	In
8	SerTFG-	Out	21	SerTFG+	Out
9	VINIT- (CC1-)	In	22	VINIT+ (CC1+)	In
10	INTEG+ (CC2+)	In	23	INTEG- (CC2-)	In
11	N/C		24	N/C	
12	N/C		25	N/C	
13	GND		26	GND	

1. Note: SerTC: Differential Serial Communication to camera; SerToFG: Differential Serial Communication to frame grabber

2.2.2 (e) Analog Output Connector

The TM-1325 has a BNC connector on the rear panel to output analog video data.

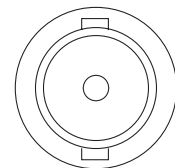

2.2.3 Shutter Speed Control Dial (TM-1325 only)

Shutter speed can be selected by switching the shutter dial to the appropriate setting (0 through 9). The factory default settings correspond to the shutter speeds as shown in below.

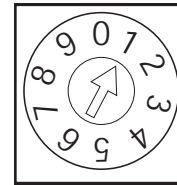
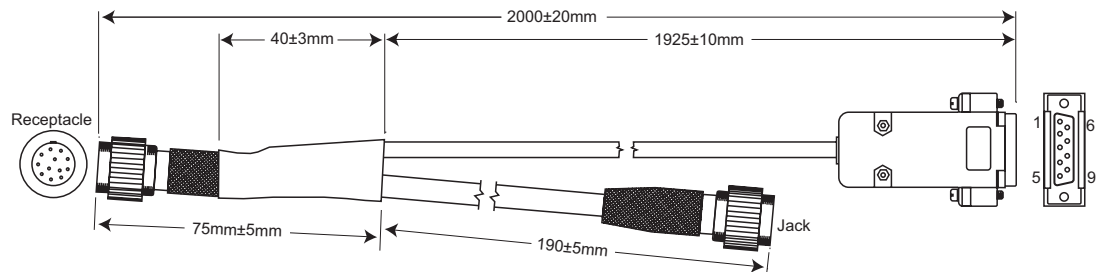

TABLE 5. Shutter Speed Control Dial

	Shutter Exposure Time (Seconds)	
	Normal	Async
0	no shutter (1/30)	no shutter (1/30)
1	1/60	1/16,000
2	1/125	1/8,000
3	1/250	1/4,000
4	1/500	1/2,000
5	1/1,000	1/1,000
6	1/2,000	1/500
7	1/4,000	1/250
8	1/8,000	1/125
9	1/16,000	Ext. pulse width control

2.2.4 RS-232 Communication Cable (TM-1325 only)

FIGURE 5. Serial Communication Cable RS-232B-12



The RS-232 controller set CS-232E includes cable RS-232B-12 interface cable, software disk, and a quick-start card. The TM-1325 camera's built-in look-up table (LUT) can be controlled by an external RS-232 interface. The camera settings can be programmed or changed using the communication cable and software. Commands from the RS-232 interface will override the rear panel switch settings of the camera. Please refer to the camera control software manual for details on the graphical user interface.

2.2.5 Digital Output Cable (TM-1325 only)

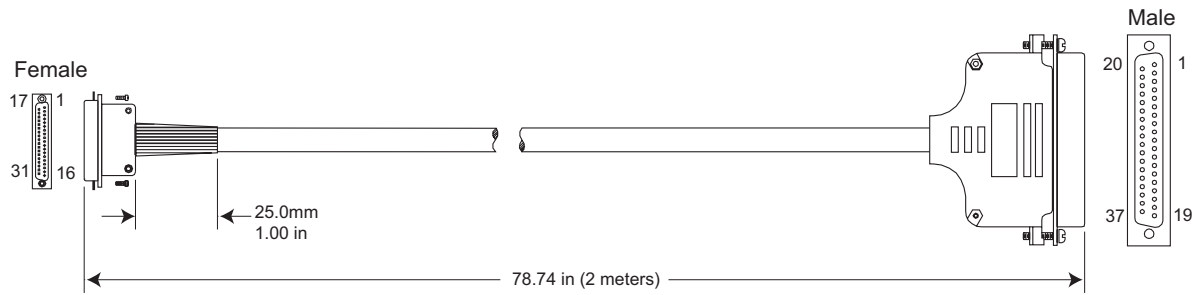

The TM-1325 camera uses the cable 30DG-02 from JAI PULNiX as a digital output cable. This cable has a 31-pin AirBorn connector on the camera end and a 37-pin D-sub male connector on the other end. Contact your JAI PULNiX representative regarding availability of interface cables for specific frame grabber models. Pinout configuration for the digital cable is shown below.

FIGURE 6. Pinout Configuration for Digital Output Cable

FROM 31 PIN CONN	TO 37 PIN CONN	WIRE COLOR	FROM 31 PIN CONN)	TO 37 PIN CONN	WIRE COLOR
PIN 1 CLK+	PIN 1 CLK+	ORG 1RED	PIN 21 VD		PNK 1BLU
PIN 2 LDV+	PIN 2 LDV+	GRY 1RED	PIN 22 **	PIN 18 NC	ORG 2BLU
PIN 3 FDV+	PIN 3 FDV+	WHT 1RED	PIN 23 GND	PIN 23 GND	GRY 2BLU
PIN 4 GND	PIN 16 GND	YLW 1RED			
PIN 5 HD		PNK 1RED	PIN 24 DØ-	PIN 27 DØ-	WHT 2BLU
PIN 6 INTEG	PIN 37 INTEG	ORG 2RED	PIN 25 D1-	PIN 28 D1-	YLW 2BLU
PIN 7 *		GRY 2RED	PIN 26 D2-	PIN 29 D2-	PNK 2BLU
PIN 8 DØ+	PIN 8 DØ+	WHT 2RED	PIN 27 D3-	PIN 30 D3-	ORG 3BLU
PIN 9 D1+	PIN 9 D1+	YLW 2RED	PIN 28 D4-	PIN 31 D4-	GRY 3BLU
PIN 10 D2+	PIN 10 D2+	PNK 2RED	PIN 29 D5-	PIN 32 D5-	WHT 3BLU
PIN 11 D3+	PIN 11 D3+	ORG 3RED	PIN 30 D6-	PIN 33 D6-	YLW 3BLU
PIN 12 D4+	PIN 12 D4+	GRY 3RED	PIN 31 D7-	PIN 34 D7-	PNK 3BLU
PIN 13 D5+	PIN 13 D5+	WHT 3RED			
PIN 14 D6+	PIN 14 D6+	YEL 3RED			
PIN 15 D7+	PIN 15 D7+	PNK 3RED			
PIN 16 NC	NC			PIN 35 GND	SHIELD
PIN 17 CLK-	PIN 20 CLK-	ORG 1BLU		N/C	
PIN 18 CDV-	PIN 21 LDV-	GRY 1BLU		PINS 4, 5, 6, 7	
PIN 19 FDV-	PIN 22 FDV-	WHT 1BLU		19, 24, 25, 26,	
PIN 20 VINIT	PIN 17 VINIT	YEL 1BLU		AND 36	

* LPULSE: TM-9701, TM-1001
 NC: AccuPIXEL
 ** ENINT: TM-9701, TM-1001
 NC: AccuPIXEL

2.2.6 Camera Link Cable (TM-1325CL only)

The MDR26 cable assembly (26CL-02-26) from 3M (part number 10226-6212VC) has been standardized as the Camera Link cable. This cable has the 26-pin MDR26 connector on both ends. This is a straight-through cable. The pin-out configuration is shown in Table 4 on page 8.

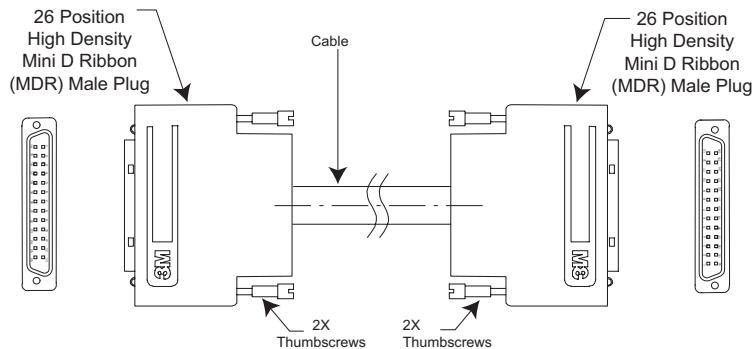

Note: For TM-1325CL, serial communication for camera control is done via the Camera Link connector on the rear panel of the camera.

Cable assemblies and boardmount receptacles can be ordered from 3M.

2.2.7 Power Supplies and Power Cable Setup

2.2.7 (a) Power Supplies

The TM-1325 requires 12V DC power that is obtained through the 12-pin connector located on the rear panel of the camera. JAI PULNiX recommends the following power supplies:

PD-12UU	100-240V AC/12V DC	1.2A universal voltage power supply with US Plug
PD-12UUP	100-240V AC	1.2A universal voltage power supply with US plug and 12-pin connector
PD-12UE	100-240V AC/12V DC	1.2A universal power supply with European plug
PD-12UEP	100-240V AC/12V DC	1.2A universal power supply with European plug and 12-pin connector

If you are providing power through the 12-pin connector, the PD-12UUP and PD-12UEP power supplies are available with the 12-pin mating connector already attached to the leads from the power supply. The PD-12UU or PD-12UE power supply can be connected to the JAI PULNiX power cable either directly or via a terminal strip.

When wiring the PD-12UU power supply directly, please note the following:

- The lead ends must be twisted together and tin-soldered for strength and electrical continuity.
- Shrink tubing or a similar insulator should be used to prevent exposed leads from touching and shorting.
- The +12V lead is marked with a red stripe or white lettering; be sure not to reverse the leads.
- All connections must be properly insulated to prevent shorting.

2.2.7 (b) PULNiX Power Cables

If you are using PULNiX power cables such as the 12P-02S, please refer to the 12-pin connector pin-out diagram in “12-Pin Connector (TM-1325)” on page 6. The cable pin-out diagram is shown in Figure 7 below. The color-coded leads use Gray for Ground and Yellow for +12V.

FIGURE 7. 12P-02S Interface Cable (optional)

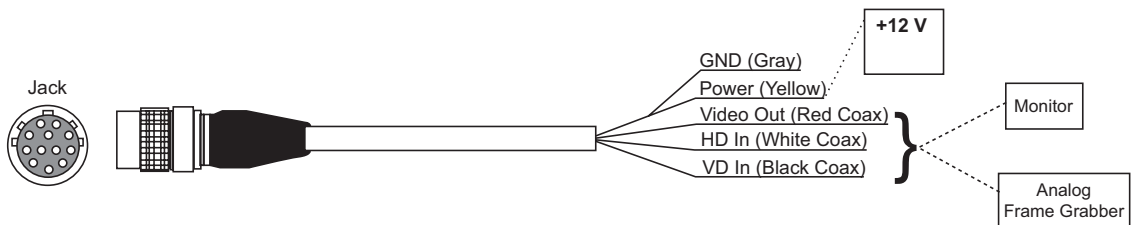

12P-02S Interface Cable					
Pin#	Lead Color	Function	Pin#	Lead Color	Function
1	Gray	GND	7	Black coax	VD Input
2	Yellow	+12V DC	8	White coax shield	Reserved
3	Red coax shield	GND	9	White coax	HD Input
4	Red coax	Video	10	Brown	RXD
5	Orange coax shield	GND	11	Blue	Integration
6	Orange coax	VINIT IN	12	Black coax shield	TXD

Note: Make sure that the unused leads are not touching and that there is no possibility that exposed wires could cause the leads to short.

2.2.7 (c) Building Your Own Power Cable

Refer to the 12-pin connector pin-out in Section 2.2.2 (a) on page 6. Connect the Ground lead to pin #1, and the +12V DC lead to pin #2 of the 12-pin connector. Power must be DC-regulated, and of sufficient current to properly power the camera.

2.2.7 (d) Attaching the Power Cable to the Connector

The 12-pin connector is keyed and will only fit in one orientation. Follow these directions to properly attach the power cable to the camera connector:

1. Rotate the connector while applying slight pressure until the keyways line up.
2. Press the connector into place until firmly seated.

3. Plug the power cord into the 100V AC socket. This will power the camera up.

2.2.8 Attaching the Analog Video Output

When connecting the TM-1325 to an analog frame grabber or a monitor, use the BNC connector on the rear panel of the camera. The input of the monitor should be balanced for 75 ohms termination. Standard RG-59 type coaxial cable should carry a full video signal for up to 100 feet. The TM-1325 has a two-row binning mode that can be used to display real-time images on PULNiX's PVM-942 or PVM-1242 monitors. These monitors are specially modified to accept a 30Hz progressive scan image.

The multi-conductor cable 12P-02S from PULNiX can be used to transmit analog video, power, sync. signals, and serial communication. The mini coaxial leads in PULNiX multi-conductor cables are designed for short runs of no longer than 100 feet.

Note: Make sure that no extraneous wires are visible which could cause a short.

2.2.9 Attaching the Camera Lens

The TM-1325 camera accepts 2/3" or larger format size C-mount lenses. To attach the C-mount lens to the camera, carefully engage the threads and rotate the lens clockwise until it firmly seats on the mounting ring. Do not force the lens if it does not seat properly. Please note that some lenses with extremely long flangebacks may exceed the mounting depth of the camera.

3 Operation

3.1 Camera Rear Panel (TM-1325)

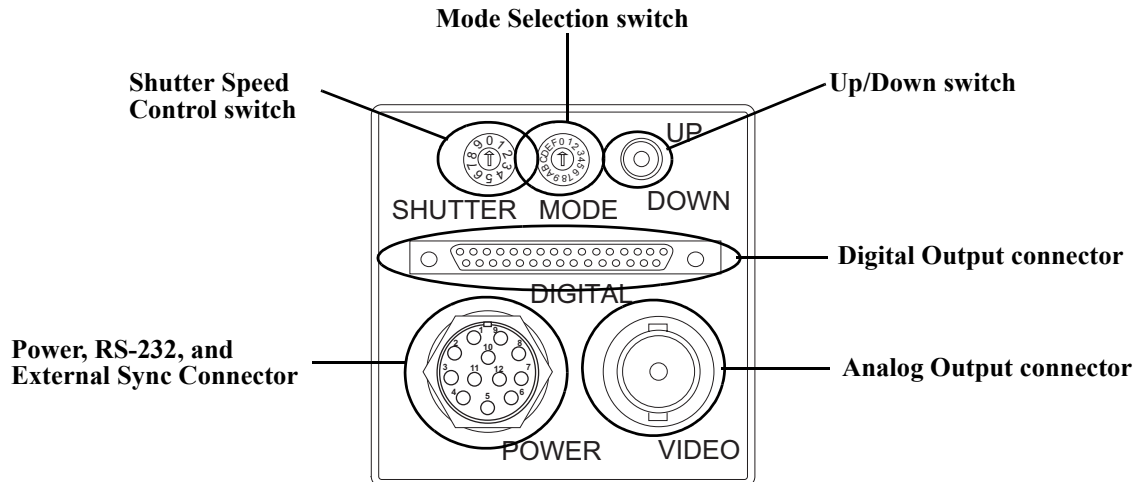

3.1.1 Up/Down Switch

The Mode Selection switch works in conjunction with the Up/Down switch. Refer to Table 6 on page 15 for information on the Up/Down switch.

3.1.2 Digital Output Connector

Refer to Section 2.2.2 (c on page 7 for information on the digital output connector.

3.1.3 Analog Output Connector

The TM-1325 camera has a BNC connector on the rear panel to output analog video data.

3.1.4 Power, RS-232, and External Sync Connector

Refer to Section 2.2.2 on page 6 for information on the power, RS-232, and external sync connector.

3.1.5 Shutter Speed Control Switch

Please refer to Section 2.2.3 on page 9 for information on the Shutter Speed Control switch. The factory default setting to the shutter speeds is no shutter.

3.1.6 Mode Selection Switch

Various modes can be implemented with the rear panel Mode Selection switch. The Mode Selection switch works in conjunction with the Up/Down switch and RS-232 external control. Commands from

the RS-232 interface will override the rear panel switch settings of the camera. The table below shows details on various modes.

TABLE 6. Mode Selection Switch

Mode Selection Switch Position	Mode Information	Up/Down Switch	Functions
0	Switch Disabled	Switch Disabled	None
1	Set Gain	Up / Down	Change Gain
2	Set Vtop (A/D)	Up / Down	Change A/D Ref. Top
3	Set Vbottom(A/D)	Up / Down	Change A/D Ref. Bottom
4	Gain Selection #1	Up: 9dB, Down: 12dB	Lower Gain Selection
5	Gain Selection #2	Up: 18dB, Down: 22dB	Higher Gain Selection
6	Linear LUT	Up	Back to Linear Table
7	Knee Selection	Up / Down (Scroll)	Scroll 8 Different LUTs
8	Async Reset mode	Up: Normal, Down: Async	Async and Normal Shutter
9	Factory Default Recall	Up / Down: Recall	Factory Setting
A	Power Up setting	Up: Recall, Down: Save	Power Up Page Setting
B	User Page Storage #1	Up: Recall, Down: Save	User Page Storage Setting
C	User Page Storage #2	Up: Recall, Down: Save	User Page Storage Setting
D	Direct Shutter control	Up: Increment Down: Decrement	Change Direct Shutter Speed in 1H Increments
E	Scan Format2	Up: PS500L Down: PS250L	Partial Scan 500L at 38 Hz Partial Scan 250L at 100 Hz
F	Scan Format1	Up: 30fps, Down: 15fps	30 fps, 15 fps

3.2 Camera Rear Panel (TM-1325CL)

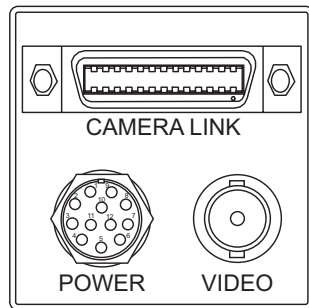

3.2.1 Digital Output Connector (Camera Link Connector)

Refer to Section 2.2.2 (d on page 8 for Camera Link information.

3.2.2 Analog Output Connector

The TM-1325CL camera has a BNC connector on the rear panel to output analog video data.

3.2.3 Power and External Sync Connector

Refer to Table 2 on page 6 for information on the power and external sync. connectors.

3.3 Progressive Scanning

Standard TV-system scanning is 525 lines interlace scanning as specified in the RS-170 protocol. Every other horizontal line (odd lines and even lines) is scanned at a 60Hz rate per field, and the scanning is completed with two fields (one frame) at 30Hz rate. Because of the interlace scanning, the vertical resolution of CCD cameras is limited at 350 TV lines, regardless of the horizontal resolution. When electronic shutter is applied, the CCD can hold only one field of charge at each exposure. Therefore, the vertical resolution of the electronic-shutter camera is only 244 TV lines. The situation is the same for an HDTV-format camera, since it has interlaced scanning and the vertical resolution of the shuttered image is 500 lines.

The TM-1325 uses a state-of-the-art progressive scanning interline transfer CCD which scans all lines sequentially from top to bottom at one frame rate (30Hz). Like a non-interlace computer screen, it generates a stable, crisp image without alternating lines and provides full vertical TV resolution of 1040 lines (a normal TV monitor display may not be able to show images due to monitor scanning).

The interline transfer architecture is also important to generate simultaneous shuttering. This is different from full frame transfer architecture which requires a mechanical shutter or strobe light in order to freeze the object motion.

The TM-1325 outputs the progressive scan image with an electronic shutter in two different formats:

- progressive scanning digital and analog output

The CCD signal goes through A/D and D/A converters and through 10-bit in, 8-bit out look-up table (LUT). The digital output is available from 31-pin connector with RS-644 format (55MHz clock rate).

The analog output is the same as 75 ohms, 1Vp-p format at 15Hz rate available from BNC and 12-pin connector.

- partial scan output (display output)

Partial scanning increases the frame rate by reducing the number of horizontal lines that are output. The TM-1325 offers the following partial scanning modes: 1392 X 500 at 58 Hz, and 1392 x 250 at 100Hz.

3.4 Electronic Shutter

The TM-1325 has a substrate drain-type shutter mechanism which provides a superb picture at various speeds without smearing. A built-in manual shutter speed control selects the electronic shutter rate of 1/60 (non-async mode only), 1/125, 1/250, 1/500, 1/1,000, 1/2,000, 1/4,000, 1/8,000, or 1/16,000 second (non-asynchronous mode only).

With VINIT high (5V), the CCD keeps discharging. With a negative pulse to VINIT, the camera resets and purges the charge momentarily. Then it starts integrating for the period of shutter control set by either an external pulse width or internal shutter control. Progressive scanning permits a full 1040 lines of vertical resolution, as compared to a conventional CCD camera which captures only half the vertical lines per shutter.

3.5 Integration

The CCD imager of the TM-1325 can be exposed for longer than the normal scan timing of 1/30 sec. This integration feature provides extra sensitivity for dark-environment applications. The progressive-scan imager permits a full frame of resolution in non-interlace format. Integration is achieved by applying INTEG signal to pin #11 of the 12-pin connector or pin #6 of the 31-pin connector, or by feeding VINIT pulse width control up to 1 sec at the pulse width. Please refer to Figure 2.2.2 on page 6 for pin-out information on the 12-pin connector.

The CCD imager of the TM-1325 can be exposed for longer than the normal scan timing of 1/30 sec. This integration feature provides extra sensitivity for dark-environment applications. The progressive scan imager permits a full frame of resolution in non-interlace format. Integration is achieved by applying INTEG signal to pin #11 of the 12-pin connector or pin #6 of the 31-pin connector, or by feeding VINIT pulse width control up to 1 sec at the pulse width.

3.6 Asynchronous Reset

The TM-1325's asynchronous reset is flexible and accepts external horizontal drive (HD) for phase locking. When the VINIT pulse is applied, it resets the camera's scanning and purging of the CCD. For asynchronous image capturing by frame grabbers, it outputs single FDV at async reset. There are two modes to control the asynchronous reset and shutter speed:

- External VINIT with pulse width (no delay shutter)
- Internal shutter speed mode

3.6.1 External VINIT With Pulse Width

The TM-1325 can be reset with external reset pulse (VINIT). Set the dial switch to "9." Apply a pulse-width control VINIT signal generated from an external event trigger to the camera. The internal reset pulse will be latched to HD and at the first HD timing from the external pulse leading edge (negative going edge). The CCD discharge pulse will be generated to clear the images. The internal VINIT will be generated at the following edge (positive going edge) of the external pulse, resetting the internal timing including the video sync. The shutter speed is the same as the external pulse width, but the integration delays 1H from the leading edge. For the immediate reset option, please contact JAI PULNiX.

For the progressive format, one frame of video output will start from the rising edge of the pulse width control. In Async mode with external pulse input high, the video output will be disabled as the camera continues discharging the CCD image, providing black video only.

FIGURE 8. Pulse Width Async Shutter Timing

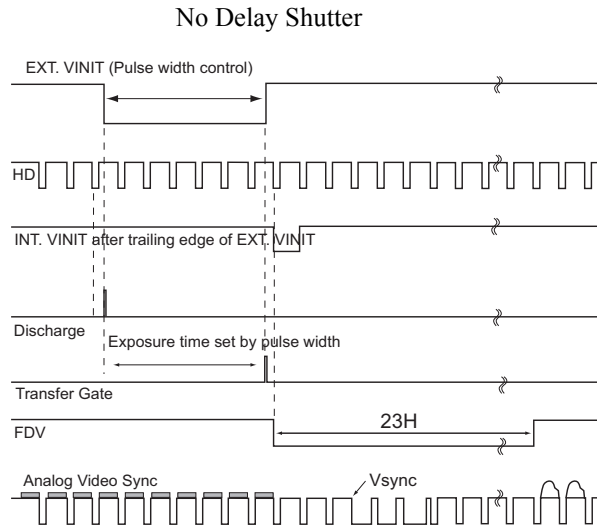

3.6.2 Internal Shutter Speed Control

The video signal starts with internal VINIT. The camera operates the reset and shutter in the same way as the external pulse width control mode. When the external VINIT pulse is applied, internal VINIT is latched to HD and the internal VINIT is delayed to set up the shutter speed period. The shutter speed is controlled by the dial switch from “1” to “8.” Video output timing starts right after the internal VINIT and single shots, FDV is output at the internal VINIT timing.

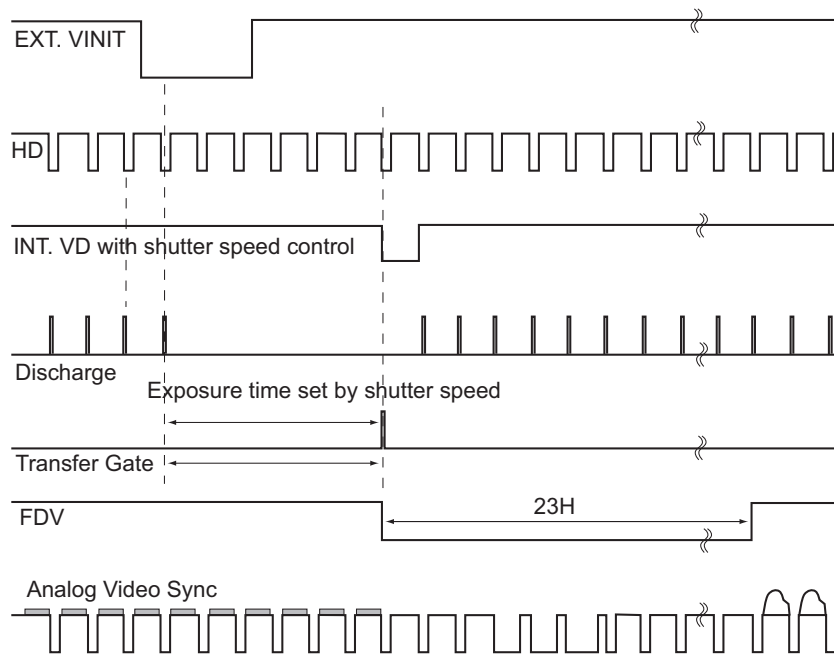

3.7 Dynamic Range Control

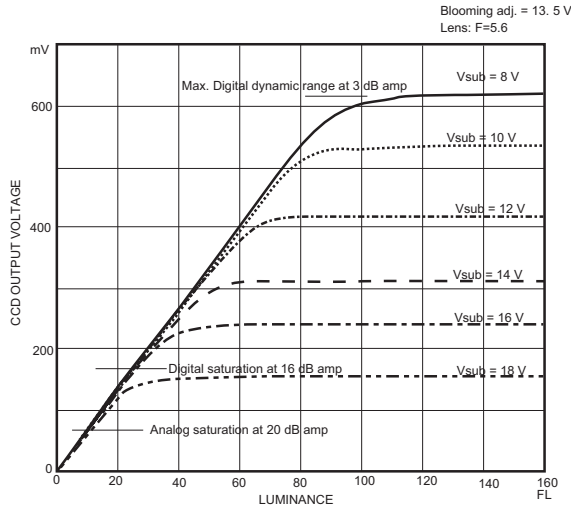

The typical interline transfer CCD has fixed noise levels based on dark current (thermal or KT noise), pattern noise, and the operating clock speed. In general, the level of the 55 MHz pixel clock CCD at room temperature is around 20 to 50 electrons. The maximum capacity of CCD charges is limited by the well capacity at saturation. The range is limited by the structure and the pixel size.

The TM-1325 uses a 2/3" CCD with 6.45 μm x 6.45 μm pixel and four-phase vertical shift register structure. The well capacity is 16,000 electrons. The theoretical dynamic range is 16,000:30 = 533:1 (54.5 dB).

A typical CCD camera does not use the full dynamic range due to the nominal gain and the output specification such as RS-170. The typical CCD camera's gain is set at 9 to 22 dB and the RS-170 video level is 714 mV. Using 20 dB gain for the calculation, CCD output is limited to 714/10 = 71.4 mV. Since the CCD's saturation voltage is 400 mV to 500 mV, it uses less than 1/5 of the full dynamic range.

Machine vision and outdoor applications cannot afford to miss image information behind the saturation, which is why the dynamic range adaptation is critical.

3.7.1 Programmable Look-Up Table (LUT) and Knee Control

The TM-1325 has a built-in LUT (look-up table) for dynamic range control.

At a specific gain setting, the offset (minimum level... dark point) and A/D reference top voltage (maximum level... saturation point) are set to 10-bit A/D input so that the full dynamic range of the CCD is utilized at 10-bit references as the input and the LUT output is converted into 8-bit to adjust the gamma correction.

The 10-bit input is segmented into two or more regions by the knee-point settings as variable gamma selection.

LUT selections: (a standard LUT is 10 sets of knee-control LUT)

- Variable Gamma
- Variable knee curve
- Direct input LUT

3.8 Scan Modes

The TM-1325 supports the following scan modes:

3.8.1 Full Progressive Scan

The normal scan mode progressively scans a full frame of 1392 x 1040 pixels at 15/30 frames per second using the standard 27.5MHz/55MHz pixel clock and a single channel output. In contrast to interlace-scan cameras, all 1040 lines in the frame are exposed simultaneously per image capture.

3.8.2 Partial Scan

Partial scan is a standard feature in the TM-1325. 500 lines and 250 lines partial scan is selectable. It outputs an image center of 500 lines and 250 lines. At 500 lines, the frame rate is 58 frames/sec. At 250 lines, it is 100 frames/sec. Partial scanning outputs the full horizontal resolution, but limits the vertical resolution to increase the frame rate. The partial scan modes are 1392 x 500 lines at 58 Hz, and 1392 x 250 lines at 100 Hz. The scan mode is selectable by using the GUI or rear panel switches (TM-1325 LVDS model only).

3.9 External Sync

The TM-1325 accepts an external sync of standard HD and VD at TTL level for general locking to a system sync and clock. The external sync is only available for 15-frame mode and the frequency requirement is as follows:

30 fps:

fHD = 31.977 KHz \pm 5%
fVD = 30.08 Hz \pm 5%
(Internal Master clock = 110.00 MHz,
Pixel clock = 55.00 MHz)

15 fps:

fHD = 16 KHz \pm 5%
fVD = 15.04Hz \pm 5%
(Internal Master Clock = 55 MHz
Pixel Clock = 27.5 MHz)

3.10 Camera Timing Charts

Model: TM-1325

Operation Mode: 15.04/30.08 fps

Master Clock: 110.00 MHz, Mclk = 9.09 nsec

Pixel Clock: 27.5/55 MHz, Pclk = 36.36/18.18 nsec

1. Pixel Clock and Digital Data

Pixel Clock

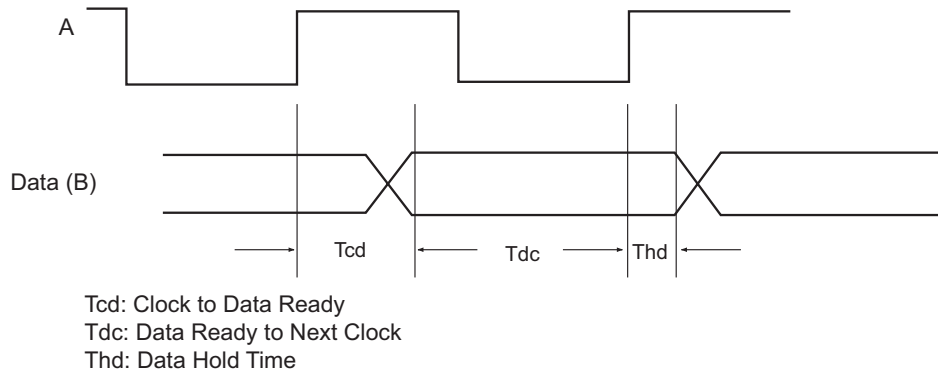

Tcd = 17.2/8.6 nsec, Tdc = 19.2/9.6 nsec, Thd = 9/4.5 nsec.

2. Horizontal Signals

fHD = [15.99/31.98 KHz]
tHD = [62.54/31.27 usec]

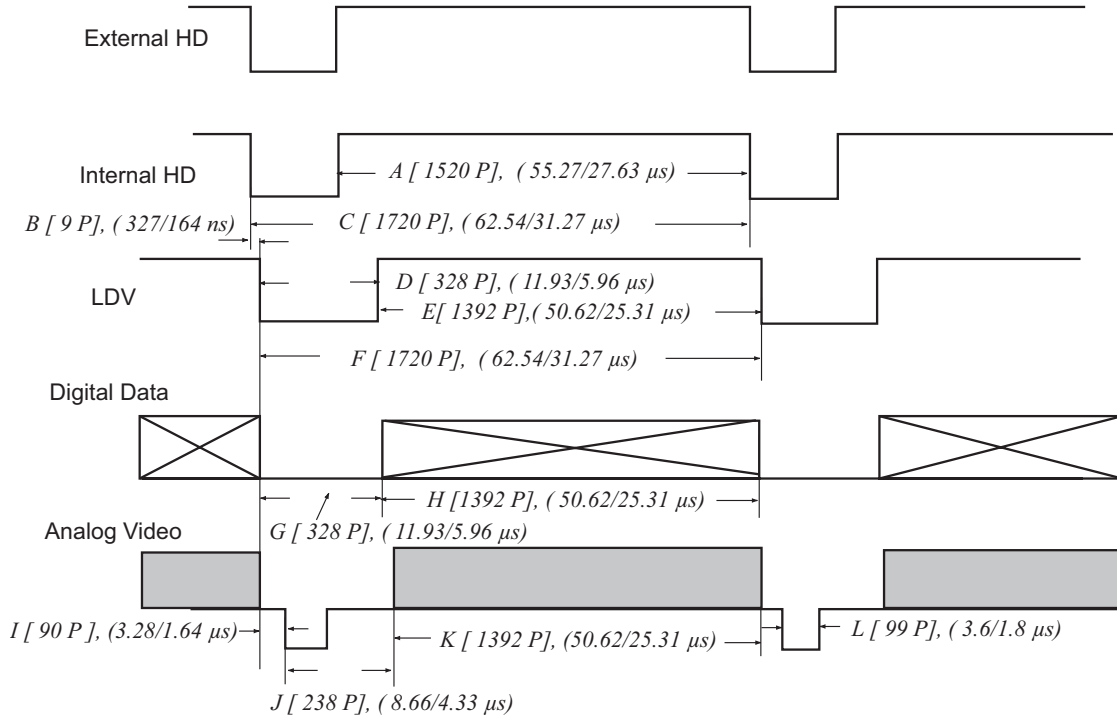

Model: TM-1325

Operation Mode: 15.04/30.08 Frames/Second

Master Clock: 110.00 MHz, Mclk = 9.09 nsec Horizontal Frequency: 15.99/31.98 KHz
Pixel Clock: 27.5/55 MHz, Pclk = 36.36/18.18 nsec 1H = 62.54/31.27 usec

3. External Reset Timing

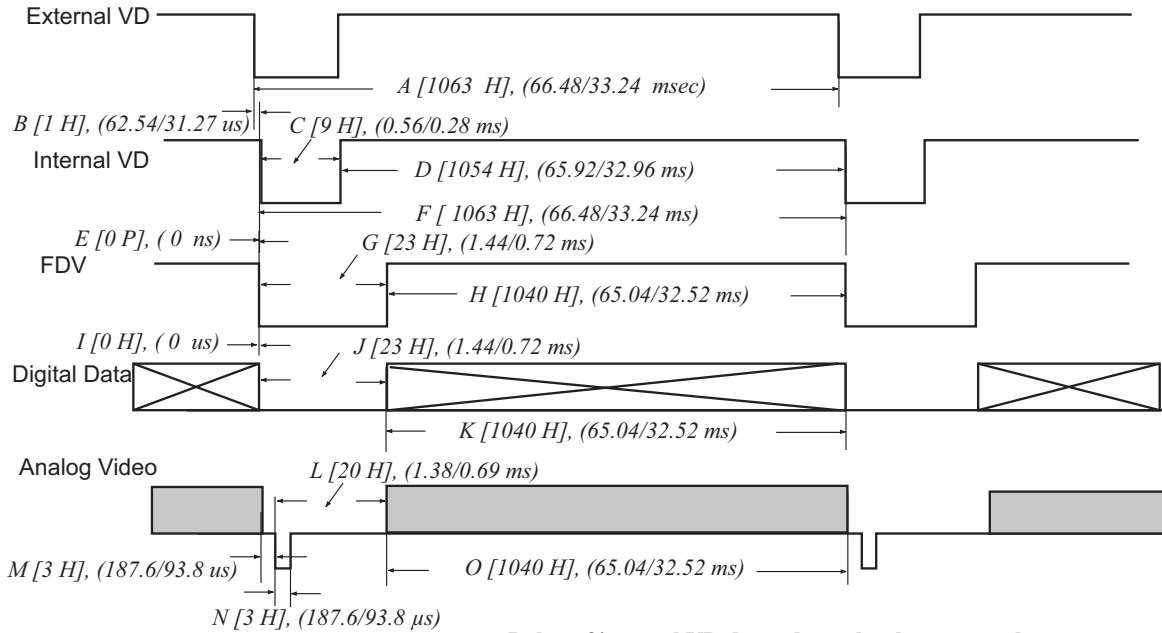

Delay of internal VD depends on the shutter speed.

4. Async Shutter Reset Timing

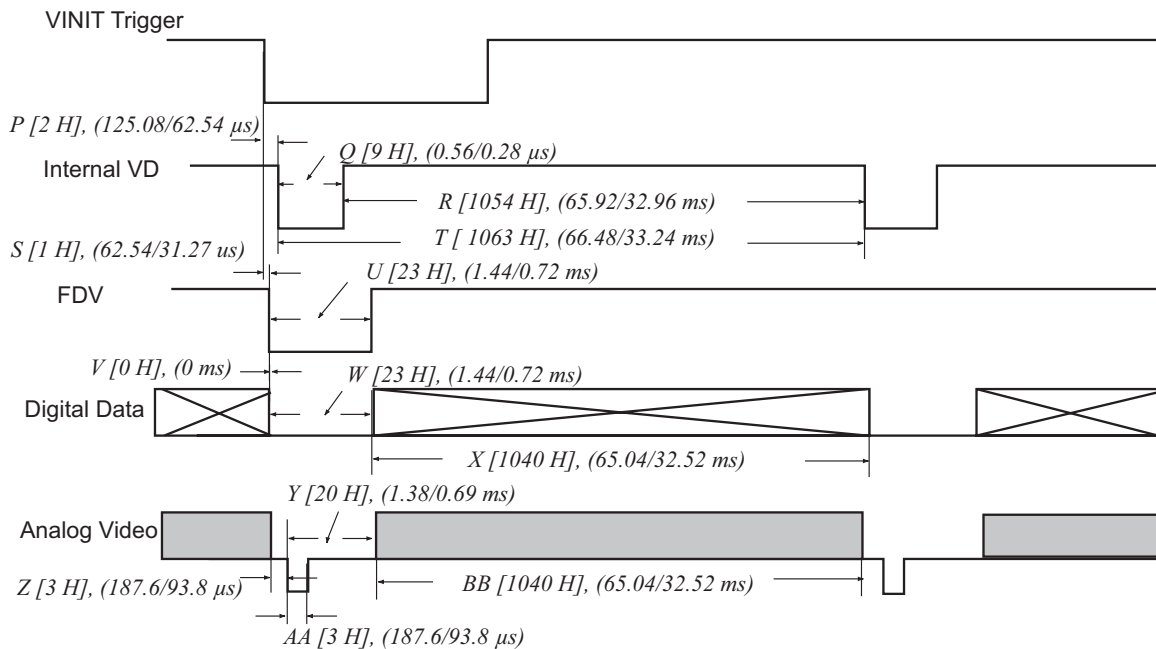

Model: TM-1325

Operation Mode: 58 Frames/Second
(Partial Scan: 500Lines)
Horizontal Frequency: 31.98 KHz
1H = 31.27 usec

Master Clock: 110.00 MHz, Mclk = 9.09 nsec
Pixel Clock: 55 MHz, Pclk = 18.18 nsec

3. External Reset Timing

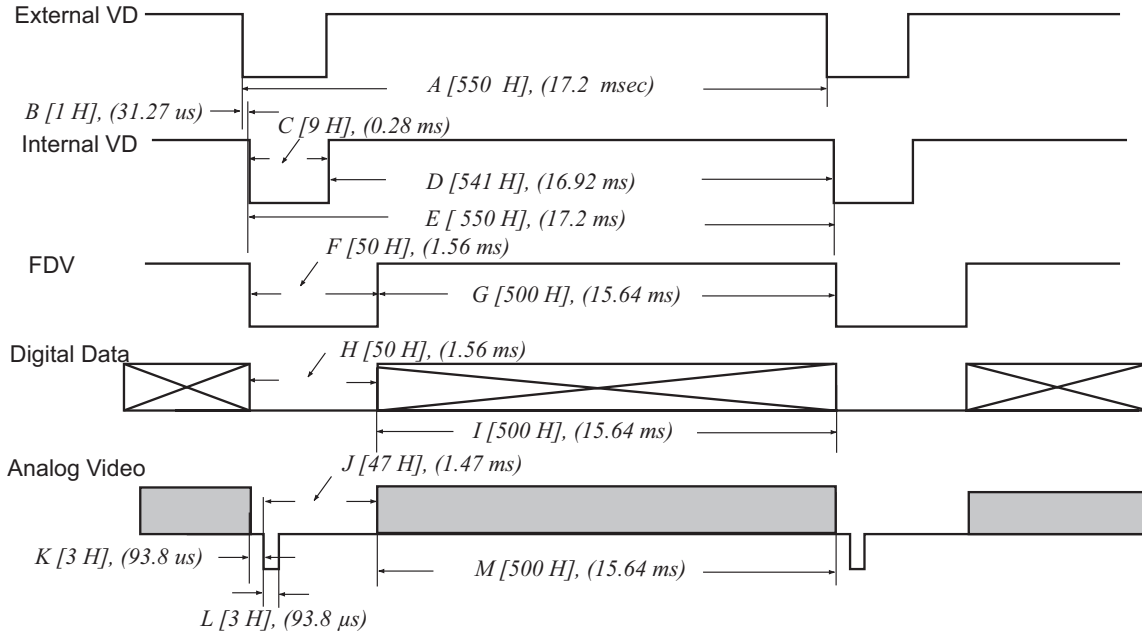

4. Async Shutter Reset Timing

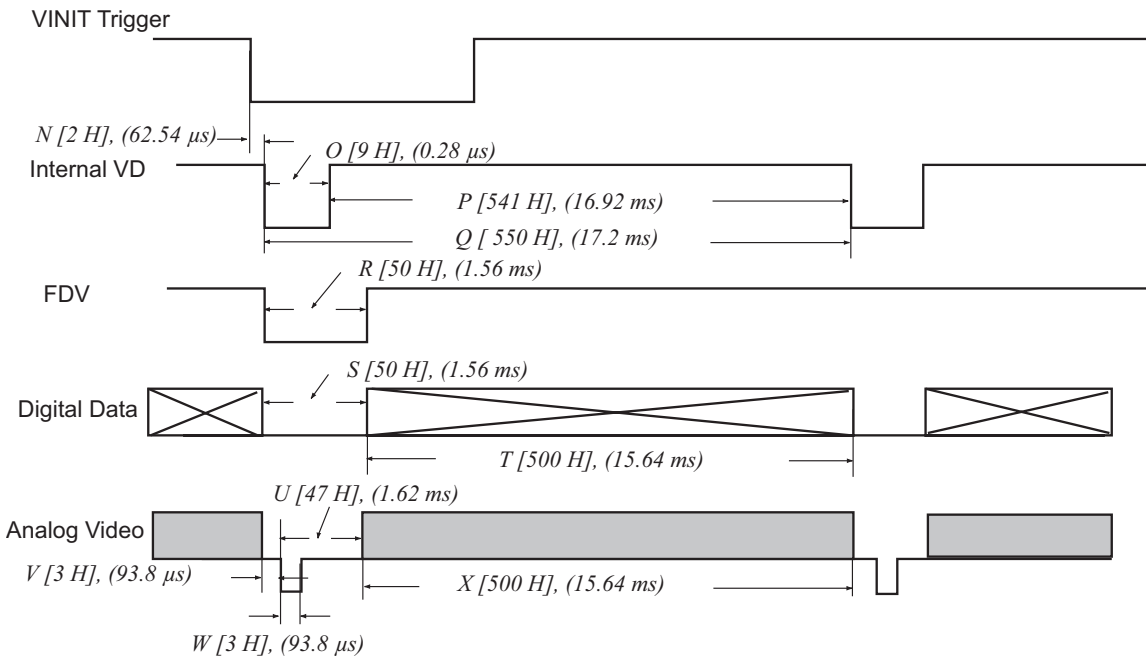

Model: TM-1325

Operation Mode: 100 Frames/Second
(Partial Scan: 250Lines)

Master Clock: 110.00 MHz, Mclk = 9.09 nsec
Pixel Clock: 55 MHz, Pclk = 18.18 nsec

Horizontal Frequency: 31.98 KHz
1H = 31.27 usec

3. External Reset Timing

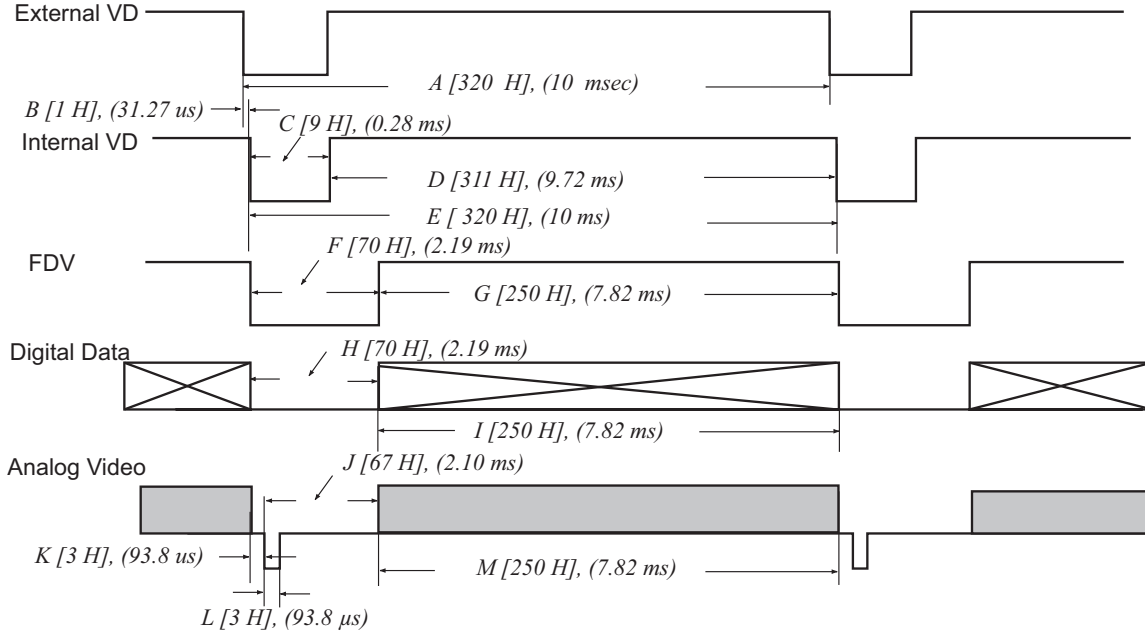

4. Async Shutter Reset Timing

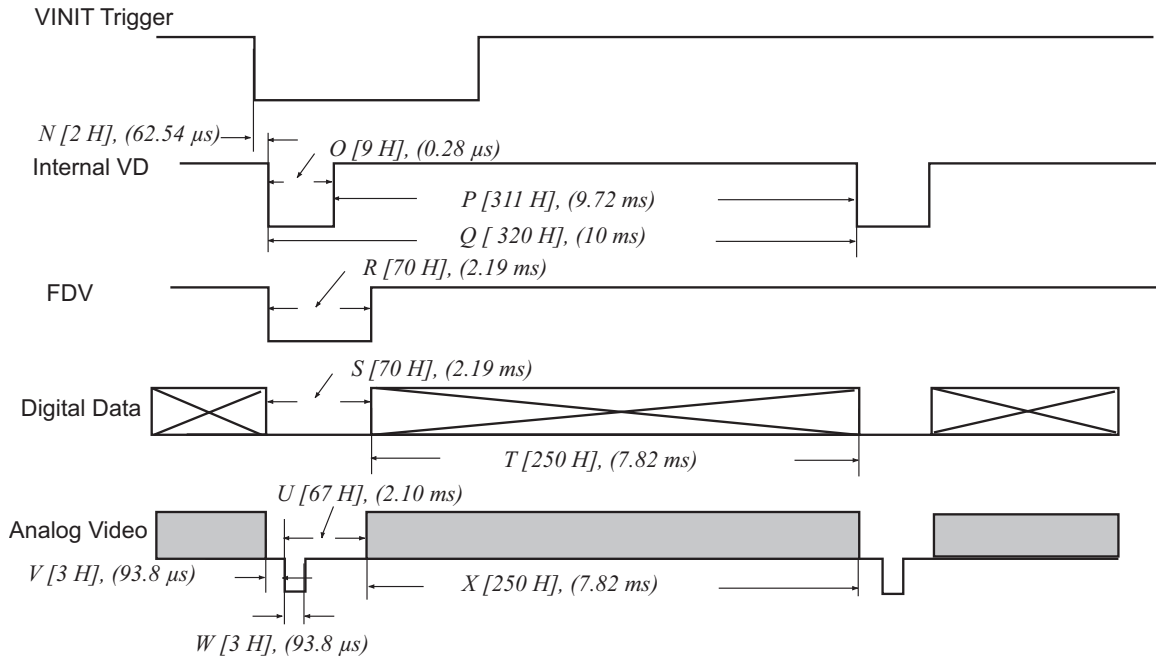

3.11 Serial Communication Kit CS-232C (not required for “CL” version)

The TM-1325's functions can be controlled by a PC via RS-232C communication using the CS-232E serial communication kit. This kit consists of the RS-232B-12 cable, software disk, and quick-start card. The software disk contains setup files for the graphical user interface (GUI) program. Refer to the camera control software manual for information on the GUI and ASCII command set.

Note: For CL models, the control software is included and serial communication is through the Camera Link cable. No additional accessories are required.

4 Troubleshooting

4.1 Problems and Solutions

Following are troubleshooting tips for common problems. In general, problems can easily be solved by following these instructions. If the following remedies fail to offer a solution to your problems, please contact a PULNiX representative.

4.1.1 Symptom: No Video

Remedies: Check that the following are properly connected and operational.

- Power supplies
- Power cables
- Main power source
- Shutter control
- Async mode
- Lens
- Digital output cable
- Analog video cable

4.1.2 Symptom: Dark Video

Remedies: Check that the following are properly connected and operational.

- Shutter selection
- Iris opening on the lens

4.1.3 Symptom: Non-Synchronized Video

Remedies: Check that the following are properly connected and operational.

- Proper mode output
- Frame grabber software camera selection

4.2 Troubleshooting Flowchart

1. No Power

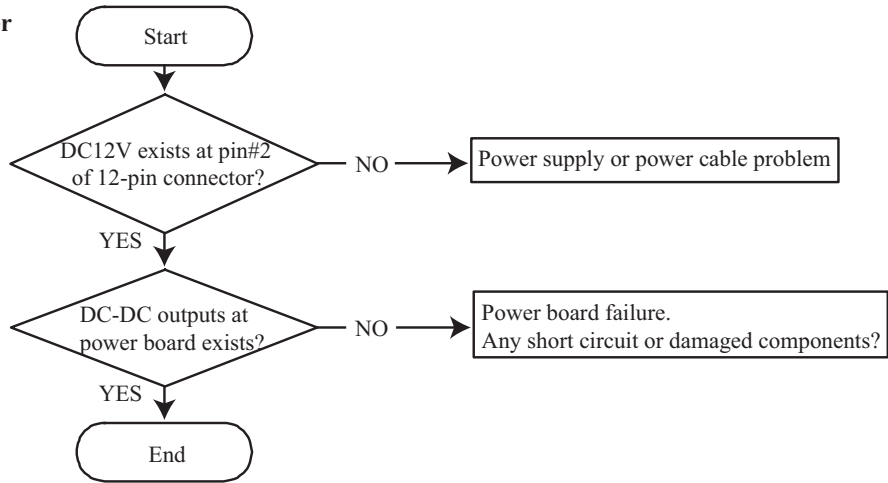

2. No Video Output

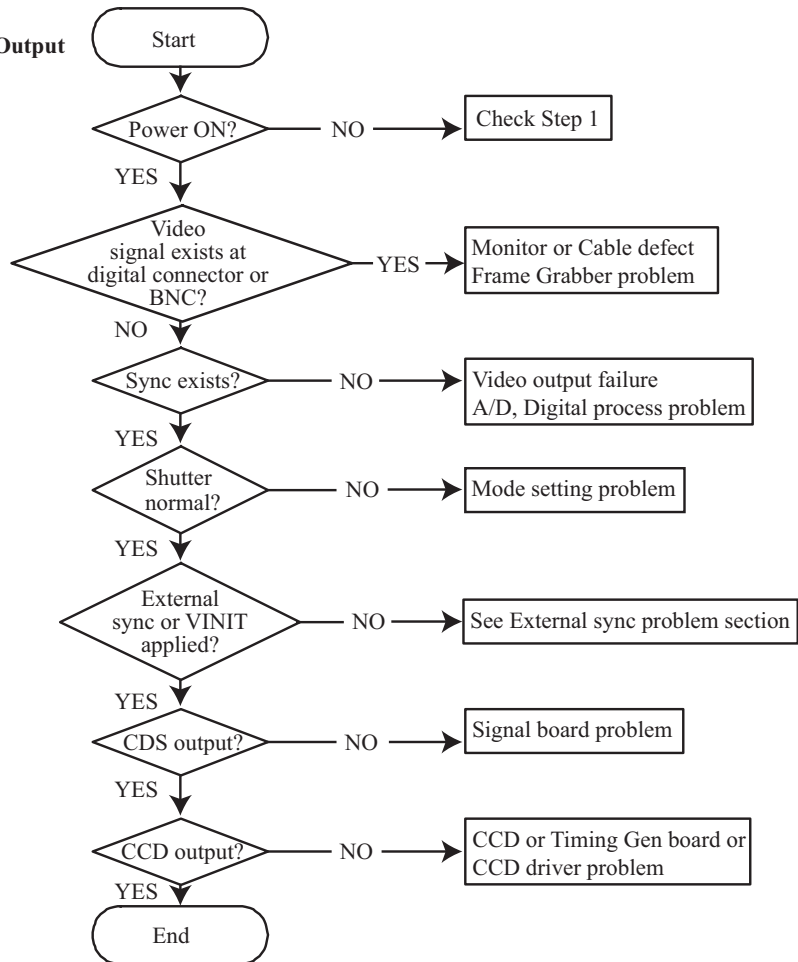

4.3 Troubleshooting Flowchart 2

3. External Sync Problem

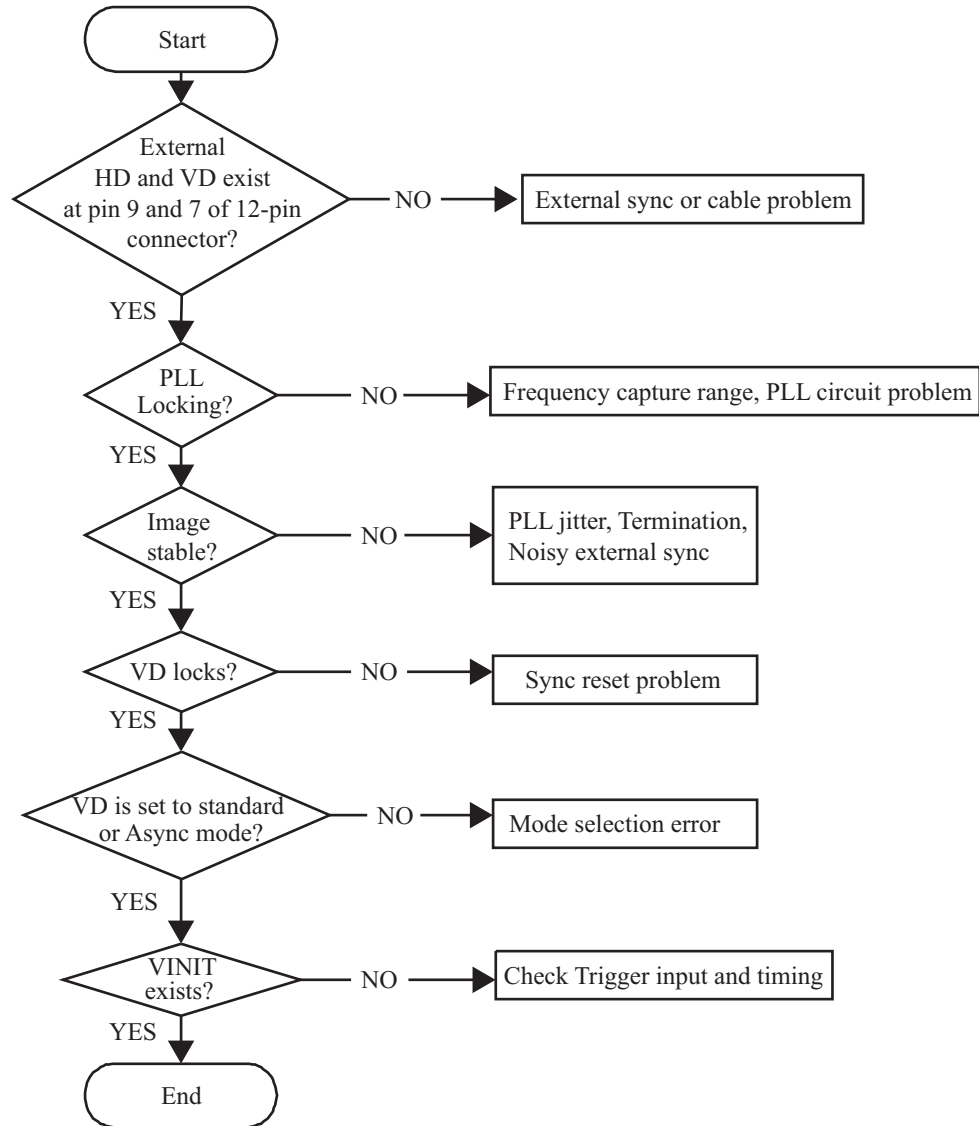

Note: Breaking the factory seal to perform these tests without prior approval from the factory will void the product warranty.

4.4 Information and Support Resources

For further information and support:

Phone:	(408) 747-0300 (800) 445-5444
Fax:	(408) 747-0660
E-mail:	pulnix@pulnix.com
Mail:	JAI PULNiX, Inc. Sales Department 1330 Orleans Drive Sunnyvale, CA 94089 ATTN: Video Applications
Web Site:	www.jaipulnix.com

5 Appendix

5.1 Specifications

TABLE 7. TM-1325 and TM-1325CL Product Specifications Table

Model	TM-1325 and TM-1325CL
Imager	2/3" progressive scan interline transfer CCD
Active Area	8.7mm x 6.9mm
Active Pixels	1392 (H) x 1040 (V)
Cell size	6.45µm x 6.45µm
Scanning (Active Pixels)	1392 x 1040 pixels 30/15 Hz selectable 1392 x 500 pixels at 58 Hz (partial scan) 1392 x 250 pixels at 100 Hz (partial scan)
Sync	Internal/external auto switch HD/VD, 4.0 Vp-p impedance 4.7K ohms VD=15/30 Hz±5%, non-interlace HD=15.99/31.98 kHz±5%
Data clock output	55.00 / 27.50 MHz
Resolution	Digital: 1392 (H) x 1040 (V) Analog: over 900 TV lines (H) x 800 TV lines (V)
S/N ratio	50dB min.
Min. illumination	1.0 lux f=1.4 (no shutter) @30fps Sensitivity: 10µV/ e-
Video output	Analog: 714mV, 75 ohms (900 mV white clip) Digital output: 8-bit RS-644 output Camera Link (TM-1325CL only)
AGC	OFF
Gamma	Programmable LUT (1.0 std.)
Lens mount	C-mount (use at least 2/3" format lenses)
Power req.	12V DC±10%, 500 mA (current measured at 25°)
Operating temp.	-10°C to 50°C ¹
Random vibration	7G _{rms} (10Hz to 2000Hz)
Shock	70G
Size (W x H x L)	44mm x 44mm x 64mm (1.73" x 1.73" x 2.51")
Weight	Without tripod mount: 133 g, 4.7 oz. (TM-1325), 140 g, 4.9 oz. (TM-1325CL) With tripod mount: 144.5 g, 5.1 oz. (TM-1325) 149.5 g, 5.3 oz. (TM-1325CL)

TABLE 7. TM-1325 and TM-1325CL Product Specifications Table

Optional Functions (must be ordered separately)	OP 97 Back-Focus Adjustment
Optional Accessories (must be ordered separately) I/O CL RS-644 Power cable Power supply	30DG-02 digital output cable, CS-232E serial communication kit, 26CL-02-26 digital output cable 12P-02S PD-12UUP series (includes power connector)

1. Refer to Section 2.2.1 on page 6 for information on camera heat dissipation.

5.1.1 Physical Dimensions

FIGURE 9. Physical Dimensions (TM-1325)

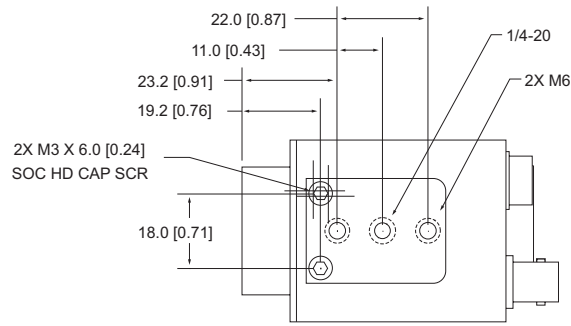
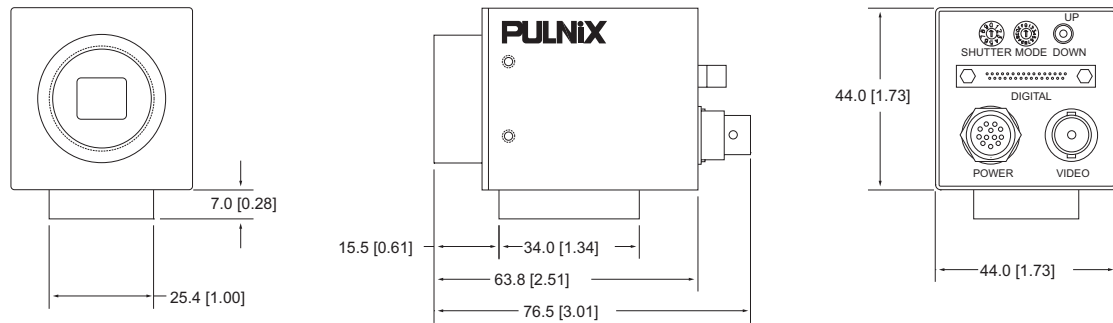
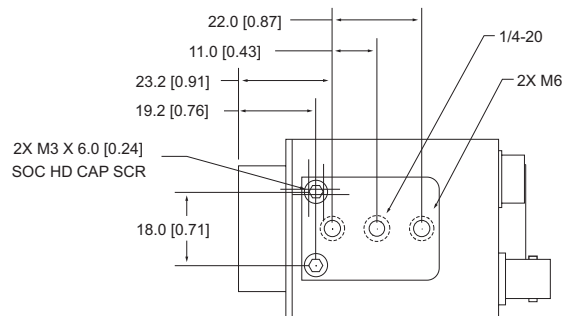
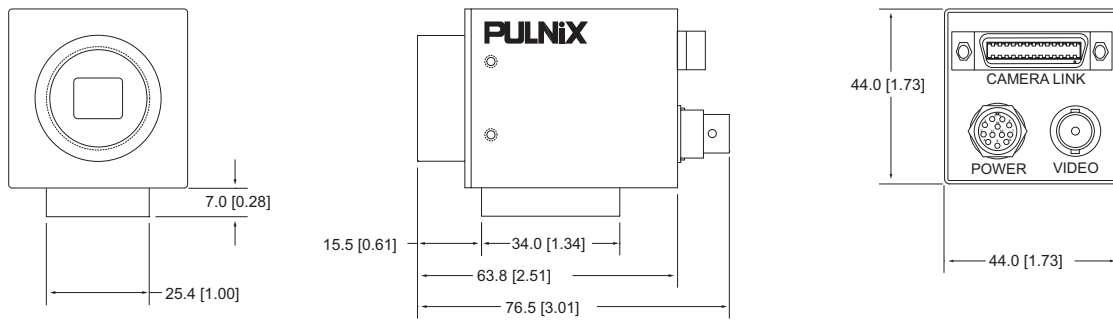
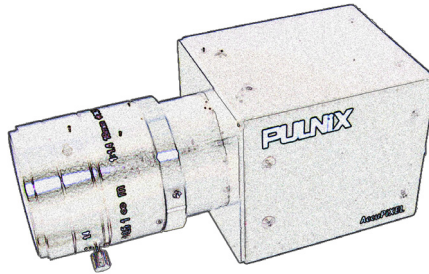

FIGURE 10. Physical Dimensions (TM-1325CL)





Imaging Products

JAI PULNiX Inc. Tel: 408-747-0300
1330 Orleans Drive Tel: 800-445-5444
Sunnyvale, CA 94089 Fax: 408-747-0660

Email: imaging@pulnix.com

www.pulnix.com