

FXO 10GigE

fxo542CXGE



General

Model	fxo542CXGE
Product code	F002095
Product series	FXO 10GigE
Status	Available

Sensor

Sensor type	Area scan
Chroma	Color
Spectrum	Visible
Spectral range	400 nm to 1000 nm
Resolution	5,320 × 3,032 (16.10 MP)
Sensor model	Sony IMX542
Sensor architecture (material)	cmos
Shutter type(s)	global-shutter
Sensor size	14.58 × 8.31 mm (16.78 mm, 16.8mm (Type 1.1))
Pixel size	2.74 μm × 2.74 μm

Pixel formats

Sensor bit depth	8-Bit,12-Bit
RGB pixel formats	bayer8, bayer12

Imaging performance

Dynamic range	72 dB
SNR	39.16 dB

Timing and gain

Max. frame rate	45.6 fps
Exposure time	21 μ s to 60 s
Gain	0.0 dB to 48.0 dB

I/Os and power

Non-isolated lines	0 x LVDS input, 0 x LVDS output, 0 x TTL input, 0 x TTL output, 2 x 24V input, 4 x Open drain output,
Specific non-isolated lines	1 x RS232 input, 1 x RS232 output, 0 x RS422 input, 0 x RS422 output,
Opto-isolated lines	1 x Optical isolated input, 0 x Optical isolated input,
Power supply	10 to 25VDC, Power over Ethernet
Power consumption	External: 9 W (typical)

Operating conditions

Operating temperature (housing)	-10 °C to 60 °C
---------------------------------	-----------------

Mechanical properties

Body dimensions (L x W x H in mm)	76 x 50 x 50
Filter/protection glass	IR-Cut 680
IP class	IP30
Lens mount(s)	C-Mount
Weight	240 g

On-board memory and FPGA

Image buffer (RAM)	896 MByte
Non-volatile memory (Flash)	32 MByte

Interfaces

Digital interface	10gige
Interface connector	(RJ-45)

FW features - image control

Exposure modes	Manual, Auto, External
Gain modes	Auto, Manual
White balance modes	auto, manual

FW features - image control

Image control features

FW Features - Image Control

FW features - camera control

Trigger modes/sync

INTERNAL,SOFTWARE,EXTERNAL

Camera control features

PTP, User Sets, POE, PWM(4), Sequencer,

Quantum Efficiency

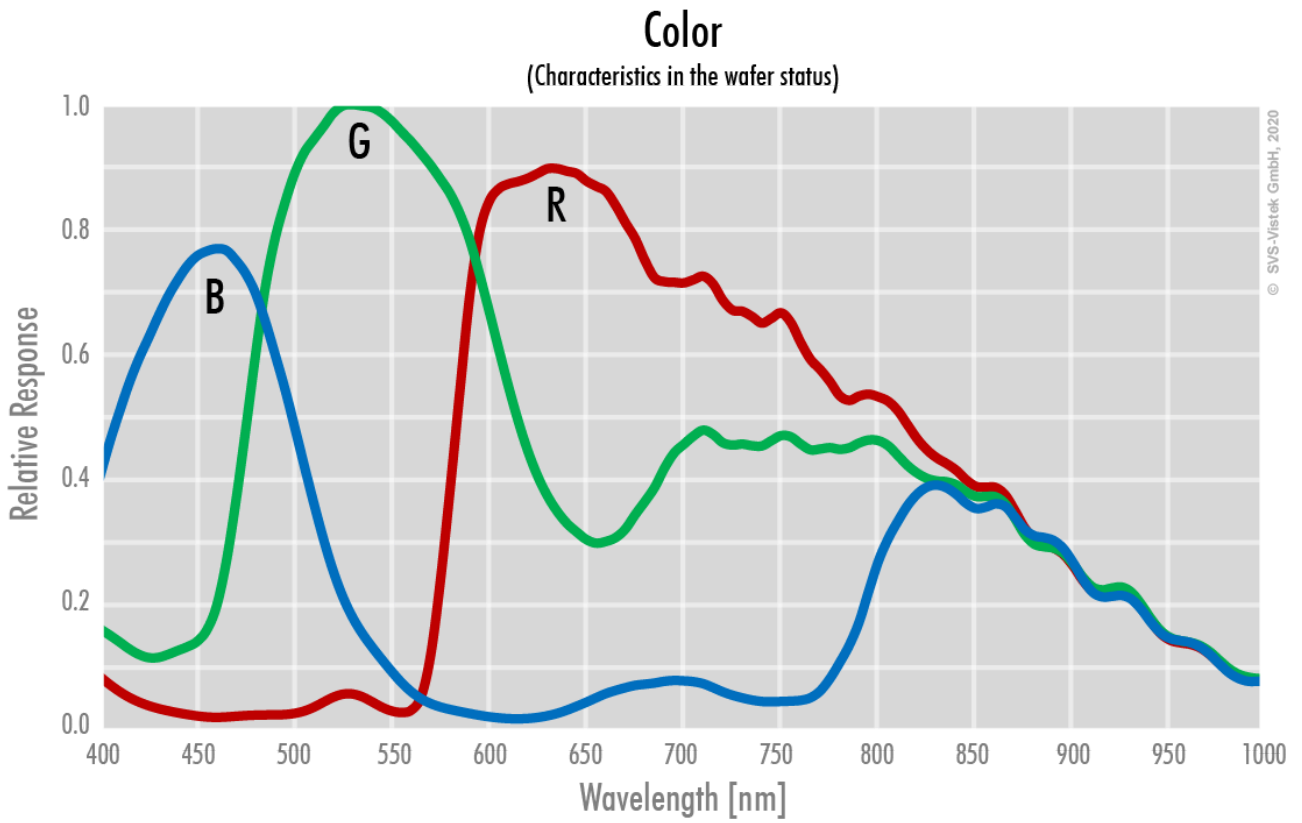

Technical Drawing

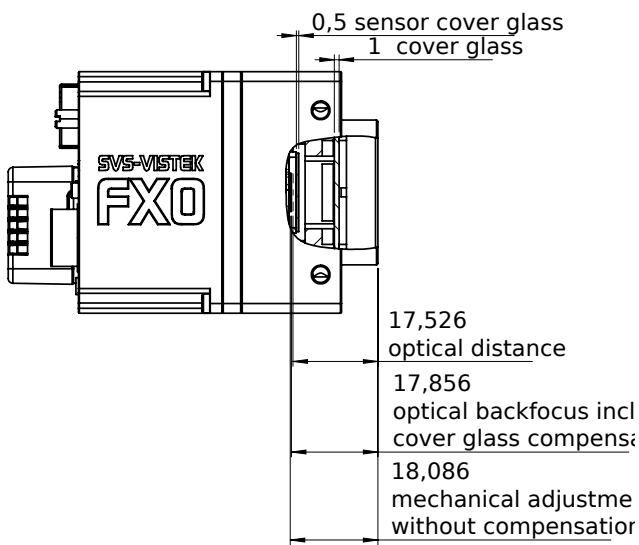
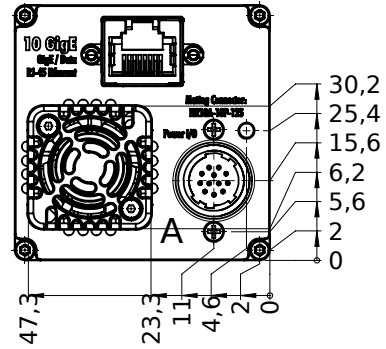
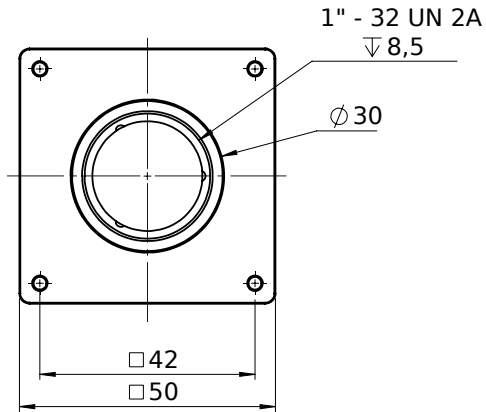

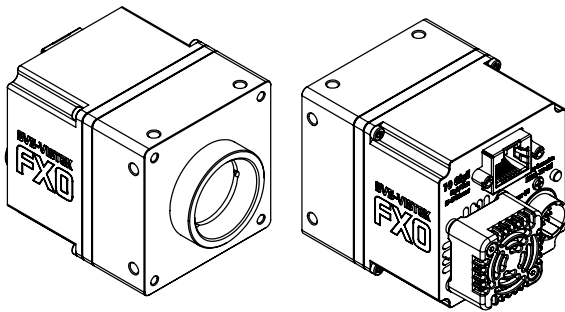
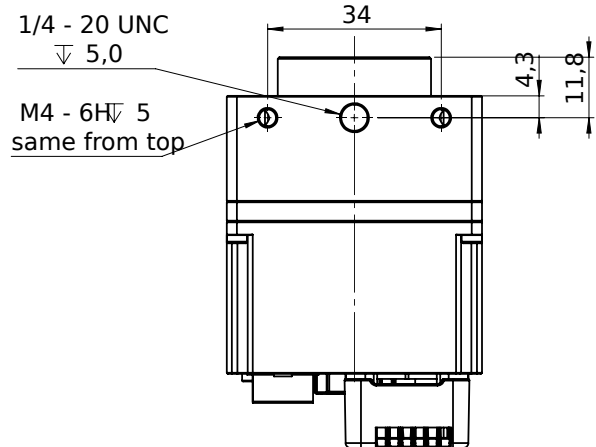
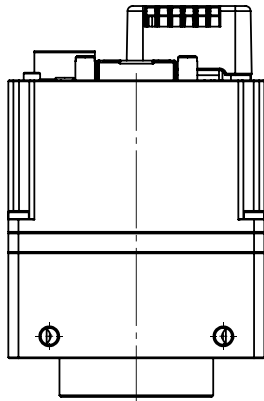

I/O pin assignment



1	VIN - (GND)	7	OUT 1 (open drain)
2	VIN + (10V to 25V DC)	8	OUT 2 (open drain)
3	IN 4 (RXD RS232)	9	IN 3 + (opto In +)
4	OUT 4 (TXD RS232)	10	IN 3 - (opto In -)
5	IN 1 (0-24V)	11	OUT 3 (open drain)
6	IN 2 (0-24V)	12	OUT 0 (open drain)