

FXO 10GigE

fxo540MXGE



General

Model	fxo540MXGE
Product code	F002090
Product series	FXO 10GigE
Status	Available

Sensor

Sensor type	Area scan
Chroma	Mono
Spectrum	Visible
Spectral range	400 nm to 1000 nm
Resolution	5,320 × 4,600 (24.50 MP)
Sensor model	Sony IMX540
Sensor architecture (material)	cmos
Shutter type(s)	global-shutter
Sensor size	14.58 × 12.6 mm (19.27 mm, 19.3mm (Type 1.2))
Pixel size	2.74 μm × 2.74 μm

Pixel formats

Sensor bit depth	8-Bit,12-Bit
Monochrome pixel formats	mono8, mono12

Imaging performance

Dynamic range	72 dB
SNR	39.11 dB

Timing and gain

Max. frame rate	30.4 fps
Exposure time	9 μ s to 60 s
Gain	0.0 dB to 48.0 dB

I/Os and power

Non-isolated lines	0 x LVDS input, 0 x LVDS output, 0 x TTL input, 0 x TTL output, 2 x 24V input, 4 x Open drain output,
Specific non-isolated lines	1 x RS232 input, 1 x RS232 output, 0 x RS422 input, 0 x RS422 output,
Opto-isolated lines	1 x Optical isolated input, 0 x Optical isolated input,
Power supply	10 to 25VDC, Power over Ethernet
Power consumption	External: 9 W (typical)

Operating conditions

Operating temperature (housing)	-10 °C to 60 °C
---------------------------------	-----------------

Mechanical properties

Body dimensions (L x W x H in mm)	76 x 50 x 50
Filter/protection glass	K9 - AR coating - 400-850nm
IP class	IP30
Lens mount(s)	C-Mount
Weight	240 g

On-board memory and FPGA

Image buffer (RAM)	896 MByte
Non-volatile memory (Flash)	32 MByte

Interfaces

Digital interface	10gige
Interface connector	(RJ-45)

FW features - image control

Exposure modes	Manual, Auto, External
Gain modes	Auto, Manual
Image control features	FW Features - Image Control

FW features - camera control

Trigger modes/sync

INTERNAL,SOFTWARE,EXTERNAL

Camera control features

PTP, User Sets, POE, PWM(4), Sequencer,

Quantum Efficiency



Technical Drawing

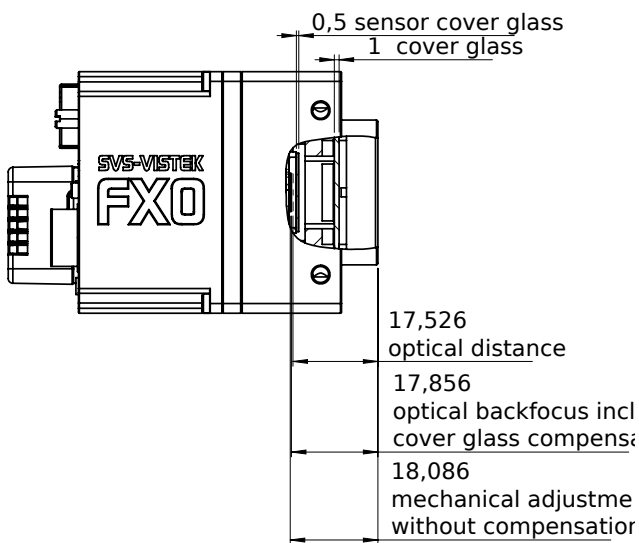
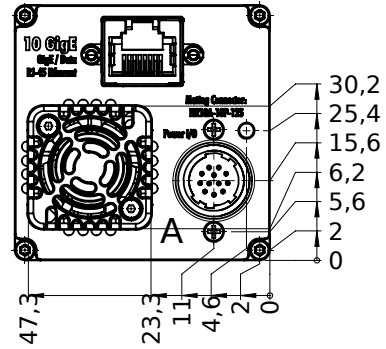
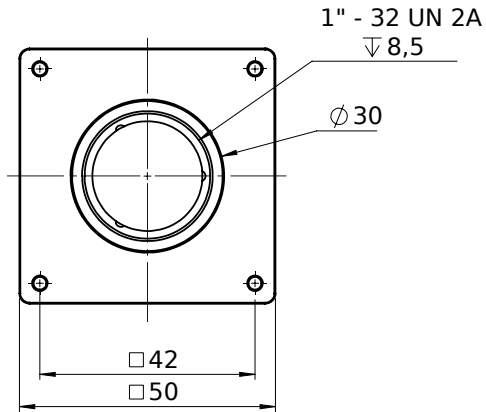

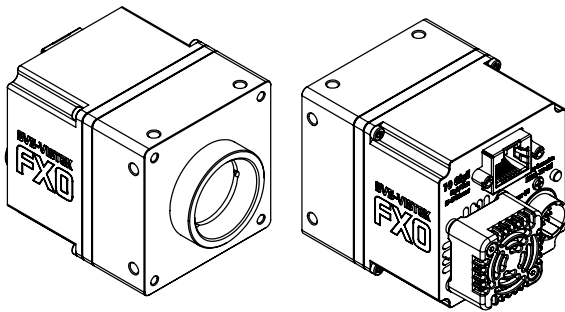
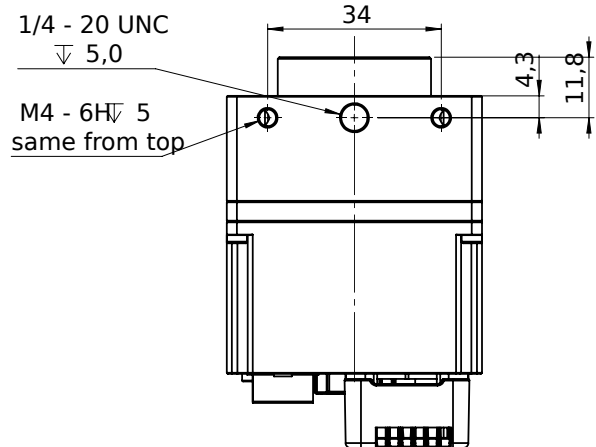
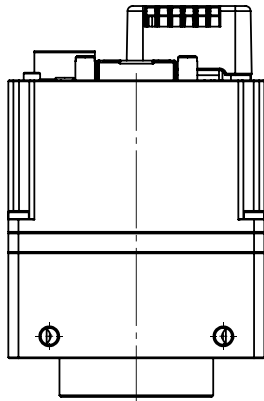

I/O pin assignment



Hirose 12 Pin	
1	VIN - (GND)
2	VIN + (10V to 25V DC)
3	IN 4 (RXD RS232)
4	OUT 4 (TXD RS232)
5	IN 1 (0-24V)
6	IN 2 (0-24V)
7	OUT 1 (open drain)
8	OUT 2 (open drain)
9	IN 3 + (opto In +)
10	IN 3 - (opto In -)
11	OUT 3 (open drain)
12	OUT 0 (open drain)