



FXO series 25GigE Manual

fxo425C25GE, fxo425M25GE, fxo537C25GE, fxo537M25GE, fxo536C25GE,
fxo536M25GE, fxo535C25GE, fxo535M25GE, fxo532C25GE, fxo532M25GE,
fxo531C25GE, fxo531M25GE, fxo530C25GE, fxo530M25GE

Content

General information	8
1.1 Company information	8
1.1.1 Disclaimer	8
1.1.2 Copyright notice	9
1.2 Legal information	9
1.2.1 Registered trademarks	9
1.2.2 Conformity and use	9
1.2.3 Rules and regulations for USA and Canada	10
1.2.4 Rules and regulations for Europe	10
1.2.5 Warranty and non-warranty clause	10
1.3 Supplements	11
1.4 Tips and notes	12
1.5 Support	12
The FXO camera series	13
2.1 25 GigE features	13
2.2 Rivermax	13
2.3 Optimized network adapter tuning	14
2.4 4I/O adds light and functionality	14
2.5 Lens control	15
2.5.1 Use of Varioptic liquid lenses	15
2.5.2 Use of Canon lenses	16
Connections	17
3.1 25 GigE Interface	17
3.1.1 Network interface cards	18
3.1.2 Address Assignment	18
3.1.3 Jumbo frames	18
3.1.4 Lost packets	19
3.1.5 Connecting multiple cameras	19
3.1.6 Multicast	20
3.1.7 XML files	20

3.2	25 GigE limitations and issues	20
3.2.1	Compatibility to nBase-T	21
3.2.2	Bandwidth limitation	21
3.2.3	Recommended setup	21
3.3	Hirose I/O connector	22
Getting started		23
4.1	Find camera specs	23
4.2	Power safety	23
4.3	Connect the camera	23
4.4	GigE IP setup	24
4.4.1	Automatic camera detection	24
4.4.2	Frame buffer settings	26
4.4.3	Optimal network adapter settings	27
4.4.4	Installing the SVGenTLRmax package	28
4.5	Cooling	29
4.6	Camera status LED codes	31
Feature description		32
5.1	Basic features	32
5.1.1	Gain	32
5.1.2	Resolution	33
5.1.3	Offset	33
5.1.4	Color	34
5.1.5	Image flipping	36
5.1.6	Binning	38
5.1.7	Decimation	40
5.1.8	GenICam	41
5.1.9	Trigger modes	42
5.1.10	Shutter modes	44
5.1.11	Exposure	44
5.1.12	Exposure speed	45
5.1.13	Auto exposure	46
5.1.14	Acquisition and processing time	46
5.1.15	Bit depth	46
5.2	Camera features	49
5.2.1	Glass filter	49

5.2.2	Shading correction	49
5.2.3	Defect pixel correction	55
5.2.4	Look-up table	60
5.2.5	ROI / AOI	63
5.2.6	Basic capture modes	63
5.2.7	Read-out control	65
5.2.8	System clock frequency	65
5.2.9	Predefined configurations (user sets)	65
5.2.10	Colour transformation control	67
5.2.11	Fan control	70
5.2.12	Precision Time Protocol	70
5.3	I/O Features	72
5.3.1	Pulse width modulation	72
5.3.2	LED strobe control	75
5.3.3	Sequencer	78
5.3.4	Optical input	81
5.3.5	PLC / Logical operation on inputs	82
5.3.6	Serial data interfaces	83
5.3.7	Trigger-edge sensitivity	85
5.3.8	Debouncing trigger signals	86
5.3.9	Prescale	87
Annex	89
6.1	Dimensions	89
6.2	I/O driver circuit schematics	89
6.3	25 GigE hardware recommendations	90
6.3.1	Cables	90
6.3.2	Requirements Mellanox ConnectX card	90
6.3.3	Transceiver modules	91
6.3.4	Recommended components	92
6.4	Action commands	93
6.5	FAQ	94

List of figures

Fig. 2-1: Illustration of 4I/O concept of switching LEDs	14
Fig. 3-1: Requirements for connecting 25 GigE	17
Fig. 3-2: Data reduction with jumbo frames	19
Fig. 3-3: Connecting multiple cameras on multiple network interface controllers	19
Fig. 3-4: Camera casting to multiple receivers (multicast)	20
Fig. 3-5: I/O Hirose connector layout	22
Fig. 4-1: Camera mounted to a heat sink (example)	30
Fig. 4-2: Camera status LED codes	31
Fig. 5-1: Noise caused by too much gain	33
Fig. 5-2: Dark noise cut off by the offset	34
Fig. 5-3: Example of Bayer pattern (source: wikipedia)	34
Fig. 5-4: Original image	37
Fig. 5-5: Horizontal flip	37
Fig. 5-6: Vertical flip	38
Fig. 5-7: Vertical binning	39
Fig. 5-8: Horizontal binning	39
Fig. 5-9: 2x2 binning	40
Fig. 5-10: Horizontal decimation	40
Fig. 5-11: Vertical decimation	41
Fig. 5-12: Mode 2: External trigger with programmable exposure time (overlap)	42
Fig. 5-13: Mode 2: External trigger with programmable exposure time (non overlap)	43
Fig. 5-14: Mode 1: External trigger with pulse width exposure control (overlap)	43
Fig. 5-15: Mode 1: External trigger with pulse width exposure control (non-overlap)	43
Fig. 5-16: Mode 1: External trigger with programmable exposure time (overlap)	44
Fig. 5-17: Mode 1: External trigger with programmable exposure time (non-overlap)	44
Fig. 5-18: Acquisition and processing time	46
Fig. 5-19: Bit depth and brightness with Sony Gen 4 sensors	48
Fig. 5-20: Original and shading corrected image	49
Fig. 5-21: Shading control disabled	51
Fig. 5-22: Illustration of a defect pixel	56
Fig. 5-23: Custom LUT adding contrast to the mid-tones	60
Fig. 5-24: Several gamma curves comparable to a LUT	61
Fig. 5-25: Several gamma curves comparable to a LUT	62
Fig. 5-26: AOI on area sensor	63

Fig. 5-27: Mode 0 - Free running with programmable exposure time	63
Fig. 5-28: Mode 1: External Trigger with Pulse Width Exposure Control (overlap)	64
Fig. 5-29: Basic capture modes - triggered mode (pulse width without overlap)	64
Fig. 5-30: Illustration of physical data stream in time	65
Fig. 5-31: Colour transformation OFF, D50, D65, TL84, A	67
Fig. 5-32: Histograms of the same image as above without and with colour transformation D50	68
Fig. 5-33: PTP set master mode	71
Fig. 5-34: PTP set slave mode	71
Fig. 5-35: Enable synced multi camera trigger in PTP slave mode	72
Fig. 5-36: PWM intensity	73
Fig. 5-37: Example: 25% PWM load	74
Fig. 5-38: Example: 50% PWM load	74
Fig. 5-39: Example: 75% PWM load	74
Fig. 5-40: The PWM module	75
Fig. 5-41: Attach LED lights to camera outputs	75
Fig. 5-42: Sequencer timing diagram	81
Fig. 5-43: Optical input	82
Fig. 5-44: UART encoding of a data stream	84
Fig. 5-45: Schmitt trigger noise suppression	85
Fig. 5-46: Bounces or glitches caused by a switch	86
Fig. 5-47: Debouncer between the trigger source and trigger	86
Fig. 5-48: The debouncer module	87
Fig. 5-49: Prescale values and their result on trigger signal	88
Fig. 5-50: The prescale module	88
Fig. 6-1: I/O driver circuit schematics	89
Fig. 6-2: Action control	93

List of tables

Table: 3-1: Hirose connector types	22
Table: 5-1: Table of dB and corresponding ISO value	32
Table: 5-2: Colour matrix fxo540, light D50	68
Table: 5-3: color matrix fxo540, light D65	69
Table: 5-4: LEDs in continuous mode	76
Table: 5-5: Example Calculation "No Flash" (CW Mode)	76
Table: 5-6: Truth table of logic function	83

Table: 5-7: Serial interface parameters – RS-232 and RS-422	83
Table: 6-1: Examples of GroupMask	93
Table: 6-2: Example of action command	94

General information

1.1 Company information

Allied Vision Gilching GmbH

Ferdinand-Porsche-Str. 3

82205 Gilching

Germany

Tel.: +49 8105 3987-60

Fax: +49 8105 3987-699

Mail: info@alliedvision.com

Web: www.alliedvision.com

1.1.1 Disclaimer

This manual contains important instructions for safe and efficient handling of our products. This manual is part of the product and must be kept accessible in the immediate vicinity of the product for any person working on or with this product .

Read carefully and make sure you understand this manual prior to starting any work with this product. The basic prerequisite for safe work is compliant with all specified safety and handling instructions.

Accident prevention guidelines and general safety regulations should be applied.

Illustrations in this manual are provided for basic understanding and can vary from the actual model of this product. No claims can be derived from the illustrations in this manual.

The product has been produced with care and has been thoroughly tested. In case of any complaint, contact your local Allied Vision distributor. You will find a list of distributors in your area on [Allied Vision Distributors](#).

1.1.2 Copyright notice

Forwarding and duplicating of this document, as well as using or revealing its contents are prohibited without written approval. All rights reserved with regard to patent claims or submission of design or utility patent.

The specification is subject to change without notice in advance. The brand and product names are trademarks of their respective companies. Any configuration other than original product specification is not guaranteed.

1.2 Legal information

Errors and omissions excepted.

These products are designed for industrial applications only. Cameras from Allied Vision Gilching GmbH are not designed for life support systems where malfunction of the products might result in any risk of personal harm or injury. Customers, integrators and end users of Allied Vision Gilching GmbH products might sell these products and agree to do so at their own risk, as Allied Vision Gilching GmbH will not take any liability for any damage from improper use or sale.

1.2.1 Registered trademarks

In this manual the following registered trademarks may be used:

- GenICam®
- Microsoft® and Windows®
- Intel®
- NVIDIA® Rivermax®

Throughout the manual, these trademarks are not specifically marked as registered trademarks. This in no way implies that these trademarks can be used in another context without the trademark sign.

1.2.2 Conformity and use

This equipment has been tested and found to comply with the limits for a Class A digital device, pursuant to Part 15 of the FCC Rules. These requirements are designed to provide reasonable protection against harmful interference when the equipment is operated in a commercial environment.

This equipment generates, uses, and can radiate radio frequency energy and, if not installed and used in accordance with the instructions given in this guide, may cause harmful interference to radio communications. Operation of this equipment in a residential area is likely to cause harmful interference in which case the user will have to correct the interference at its own expense.

You are herewith cautioned that any changes or modifications not expressly approved in this description could void your authority to operate this equipment.

1.2.3 Rules and regulations for USA and Canada

This device complies with part 15 of the FCC Rules. Operation is subject to the following conditions: (1) This device may not cause harmful interference, and (2) this device must accept any interference received, including interference that may cause undesired operation.

This equipment is compliant with Class A of CISPR 32. In a residential environment this equipment may cause radio interference.

This equipment has been tested and found to comply with the limits for a Class A digital device, pursuant to part 15 of the FCC rules.

It is necessary to use a shielded power supply cable. You can then use the "shield contact" on the connector which has GND contact to the device housing. This is essential for any use. If not done and the device is destroyed due to Radio Magnetic Interference (RMI) WARRANTY is void!

- Power: US/UK and European line adapter can be delivered. Otherwise use filtered and stabilized DC power supply.
- Shock & vibration resistance is tested. For detailed specifications refer to the section on specifications.

1.2.4 Rules and regulations for Europe

This device is CE tested, the following rules apply:

- EN 55032:2015
- EN 61000-6-2:2019

The product is in compliance with the requirements of the following European directives:

- 2011/65/EU
- 2015/863/EU

All products of Allied Vision Gilching GmbH comply with the recommendation of the European Union concerning RoHS rules.

1.2.5 Warranty and non-warranty clause

The camera does not contain serviceable parts. Do not open the body of the camera. If the camera has been opened, the warranty will be void.

The camera has to be used with a supply voltage according to the camera's specification. Connecting a lower or higher supply voltage, AC voltage, reversal polarity or using wrong pins of the power connector may damage the camera. Doing so will void warranty.

Our warranty does not protect against accidental damage, loss, or acts of nature.

Allied Vision Gilching GmbH cannot be held responsible for the loss of data. We recommend a backup plan.

1.3 Supplements

FOR CUSTOMERS IN CANADA

This apparatus complies with the Class A limits for radio noise emissions set out in Radio Interference Regulations.

POUR LES UTILISATEURS AU CANADA

Cet appareil est conforme aux normes Classe A pour bruits radioélectriques, spécifiées dans le Règlement sur le brouillage radioélectrique.

LIFE SUPPORT APPLICATIONS

The products described in this manual are not designed for use in life support appliances or devices and systems where malfunction of these products can reasonably be expected to result in personal injury.

Allied Vision Gilching GmbH customers using or selling these products for use in such applications do so at their own risk and agree to fully indemnify Allied Vision Gilching GmbH for any damages resulting from such improper use or sale.

1.4 Tips and notes

This manual contains notes that help to avoid data loss or camera damage, and tips that provide information to improve handling the camera. They are marked as follows:

TIPS

Provides information that may help to improve camera handling or avoid data loss.

NOTES

Provides information to avoid damage to the system.

1.5 Support

In case of issues with the camera we are happy to help. For being able to help you in a fast and efficient way, we ask you for a description of the issues using camera in your support request.

1. Put your support request to us via the support form: [Support & Repair \(RMA\)](#)
2. Fill the form with information about the camera model, the frame grabber model, and operating system. Our support team will come back to you.

The FXO camera series

2.1 25 GigE features

25 GigE keeps the 1 GigE benefits in network topology. Network access is transparent.

25 GigE on copper lines is a standard existing for years already in professional internet technology. Basically, it keeps the benefits and fundamental ideas of GigE and adds up to 25 times higher speed. There are two main disadvantages compared to 1 GigE:

- Higher heat dissipation
- Reduced cable lengths

However, the increased power dissipation still will result in slightly larger camera housings.

2.2 Rivermax

In conjunction with an NVIDIA Mellanox ConnectX network card (NIC), our 10 GigE / 25 GigE cameras can be operated with the Rivermax SDK. The Rivermax license and our own Rivermax transport layer ensures fast offload packet handling in the Mellanox NIC and reduces the load on the CPU and system which results in stable image acquisition.

- For more information about NVIDIA Rivermax, visit <https://developer.nvidia.com/networking/rivermax>
- For additional information about the licensing and acquiring procedure also check this link: [https://developer-download.nvidia.com/networking/nvidia-rivermax-license-generation-procedure.pdf](https://developer.download.nvidia.com/networking/nvidia-rivermax-license-generation-procedure.pdf)

2.3 Optimized network adapter tuning

For best performance on Windows, 10 GigE adapters still need some manual tuning (refer to "[Recommended setup](#)" on page 21).

All 10 GigE and 25 GigE interface cards require Windows 10 or later. Latest Linux versions are supported as well.

2.4 4I/O adds light and functionality

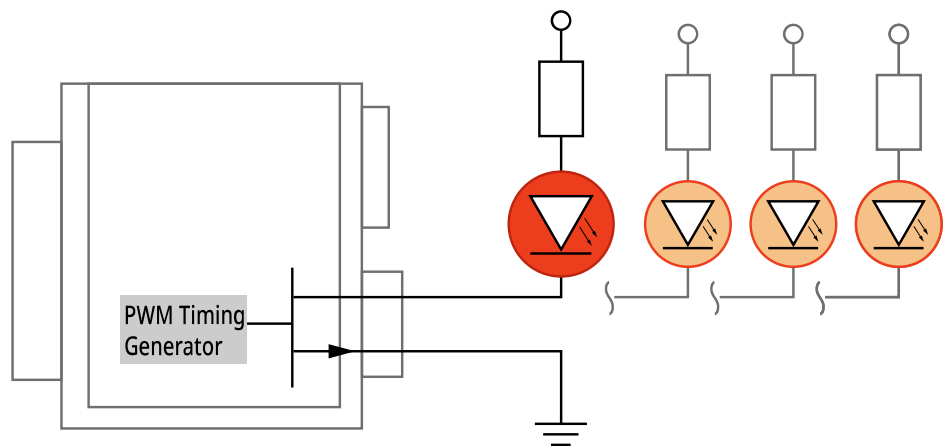

Fig. 2-1: Illustration of 4I/O concept of switching LEDs

The camera is equipped with the 4I/O-interface allowing full light control, replacing external strobe controllers. Each of the outputs can be individually configured and managed using pulse width modulation. With its high current output, the camera is able to drive LED lights directly without external light controller.

The integrated sequencer allows multiple exposures with settings to be programmed. Logical functions like AND / OR are supported.

- Up to 4 x open drain high power OUT
- Up to 4 x high voltage IN – TTL up to 25 Volts
- Power MOSFET transistors
- PWM strobe control
- Sequencer for various configurations
- PLC functionality with AND, OR and timers
- Safe trigger (debouncer, prescaler, high low trigger)

2.5 Lens control

Various SVCam models are supporting adjustable lenses. Focus and iris of the lens can be controlled from within the camera GenICam tree. Depending on the camera series, a special Y-cable is required, contact [Allied Vision](#).

The following variable lens types are supported:

- Birger mount: Ask [Allied Vision](#) for information of usability and restrictions of the Birger adapter.
- Varioptic liquid lens: Control of extremely fast focus cycles. Make sure sensor diameter is covered by lens.
- Canon EF/EF-S lens: Focus and iris control is supported. Use Canon lenses with machine vision applications. The SVCam-EF lens adapter can be acquired from Allied Vision.

Lens control (except MFT) will make use of the serial ports of the Hirose connector.

2.5.1 Use of Varioptic liquid lenses

We are supporting Varioptic liquid lenses. The liquid lens support does variable focus only, zoom and aperture control are not existing with the Varioptic liquid lens. You need a special serial cable with Hirose for connecting the lens to the camera, please ask your dealer. Being extremely fast and robust, the liquid lens is best choice as long as variable focus is sufficient in the application and you do not need a full lens control with aperture control and zoom functionality. In case of full lens control requirement, please refer to the TRACER series.

The lens is powered and controlled by the camera. The lens can be controlled via SDK functions or more easily via GenICam property.

Liquid lenses do have some advantages and disadvantages compared to glass optics:

- Advantages of liquid lenses
 - Extremely robust to mechanical shock (best choice for fast moving robotics) and acceleration
 - Fast focus (often significantly faster than 10 ms under common conditions)
- Disadvantages of liquid lenses
 - Limited resolution
 - High chromatic aberration
 - Any acceleration (gravitational as well as acceleration from movement) might increase spherical aberration as long as the force is working (will disappear if force has ceased within several 10 ms)

2.5.2

Use of Canon lenses

We are supporting Canon EF lenses. The SVCam-EF lens adapter gives you the possibility to mount Canon EF lenses with full control of focus and iris. Canon lenses are well known for their optical excellence and combine perfectly to high resolution machine vision cameras.

This camera series does have the firmware support already included in the GenICam tree and provides you with Canon lens control in all GenICam based software packages.

Connections

Cameras from Allied Vision feature a combined I/O and power supply connector (Hirose) and a data connector.

3.1 25 GigE Interface

With the 25 GigE interface in the machine vision industry new components are required to operate your machine vision system with high performance. 25 GigE is usually transmitted via fiber optics. However, you can also use 10 GigE Vision systems with a 25 GigE components set-up.

To connect a 25 GigE camera with your computer you need 4 components:

- Camera
- Transceiver module (SFP)
- Cable
- Transceiver module (SFP)
- Network interface card

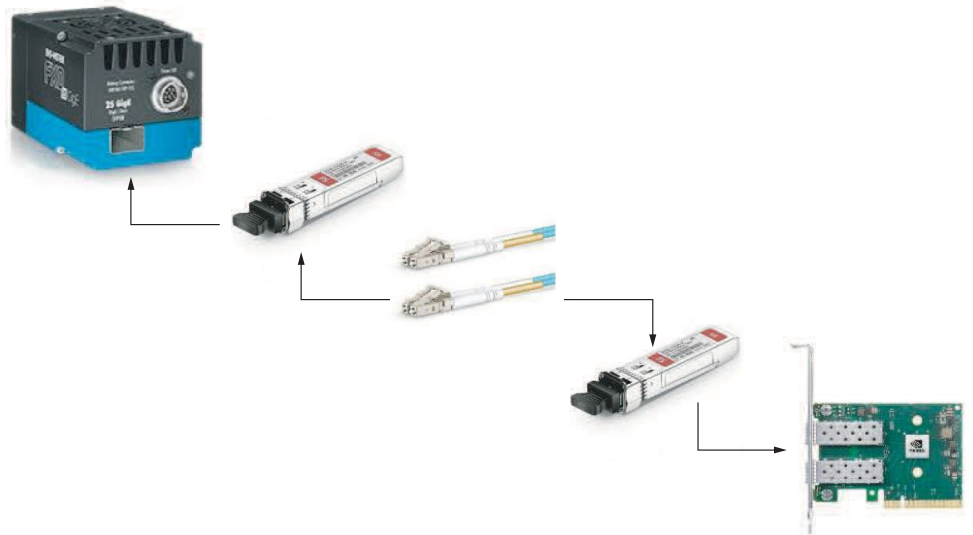

Fig. 3-1: Requirements for connecting 25 GigE

3.1.1

Network interface cards

Allied Vision Gilching GmbH cameras have been tested with NVIDIA Mellanox ConnectX-6 LX and NVIDIA Mellanox ConnectX-5. An additional Rivermax licence for Mellanox network interface cards improves stability of the data stream and reduces CPU usage.

NVIDIA MELLANOX CONNECTX-6 LX

For new designs we recommend NVIDIA Mellanox ConnectX-6 LX.

- 2 x 25 Gb/s
- PCIe x8 (Gen3 / Gen4) Rivermax compatibility
- SFP28 / QSFP28 Transceiver ports
- <https://www.nvidia.com/en-us/networking/ethernet/connectx-6-lx/>

For optimum performance, install the network card in the PCIe slot closest to the CPU.

SFP Transceiver (all Types) do not support Power-over-Ethernet (PoE).

3.1.2

Address Assignment

By default, the camera does not have a persistent IP address.

When forcing an IP address by using the PC internal network dialog, changes are only valid until the next restart of the camera.

For a peer-to-peer connection of a GigE camera to a PC a network address assignment based on LLA (Local Link Address) is recommended. This involves a network mask "255.255.0.0" as well as a fixed preamble "169.254.xxx.xxx" of the network address range. A GigE camera will fall back to LLA when no DHCP server is available and no fixed network address is assigned to the camera.

3.1.3

Jumbo frames

The transport efficiency in the streaming channel can be improved by using "jumbo frames". This will reduce overhead caused by maintaining header data upon each data packet sent. Jumbo frames increase the data size per Ethernet packet.

We recommend to set the value "9014" for the activated "Jumbo Packet".

Jumbo Frame



same Frame



Fig. 3-2: Data reduction with jumbo frames

Higher packet sizes require network cards that support jumbo packets.

3.1.4 Lost packets

In accordance with the PCT protocol, lost or corrupted packets will be resent.

Resends result in higher consumption of bandwidths and will lead to drop frames. High quality cables prevent resends.

3.1.5 Connecting multiple cameras

Multiple GigE cameras can be connected to a PC either via a switch or using dual or quad port network interface cards (NIC).

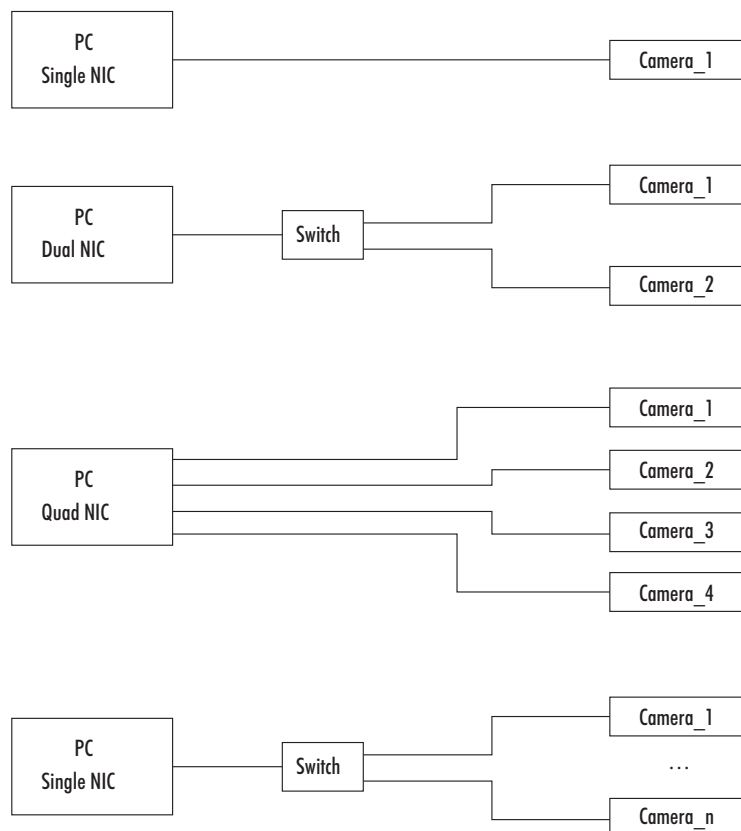

Fig. 3-3: Connecting multiple cameras on multiple network interface controllers

To connect multiple cameras by a switch, the switch must be managed. It might also be necessary to operate the cameras in an “inter packet delay” applying a smoother image data stream.

Dual GigE connection is not supported when using a switch.

3.1.6

Multicast

When images from a single camera need to be delivered to multiple PCs, multicast (RFC2236) is used. A switch receives an image data stream from a camera and distributes it to multiple destinations in this mode.

Since a GigE camera always needs a single controlling application, there will be only one master application. The controlling master application has to open a camera in multicast mode (IP 232.x.x.x for local multicast groups) in order to allow other applications to connect to the same image data stream. Other applications will become listeners to an existing image data stream. They do not have control access to the camera; however, potential packet resend requests will be served in the same manner as for the controlling application.

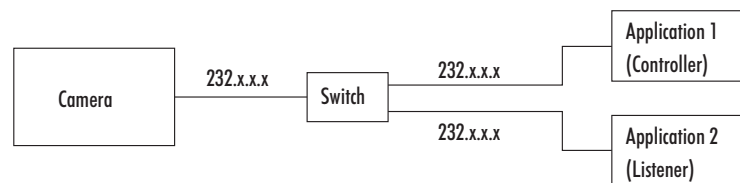

Fig. 3-4: Camera casting to multiple receivers (multicast)

3.1.7

XML files

According to the GigE Vision standard a GigE camera provides an XML file that defines the camera's capabilities and current settings.

The XML file can be processed by software like SVCapture allowing displaying and saving it to disk. Settings can also be saved and restored on the Camera internal EEPROM.

3.2

25 GigE limitations and issues

25 GigE is a high performance network protocol. Make sure the host computer performance is sufficient to digest the amount of data in terms of software and hardware components, especially the combination of motherboard and network interface card (NIC).

3.2.1 Compatibility to nBase-T

Our 10 GigE cameras supports 1 GigE, 2.5 GigE and 5 GigE (nBase-T), upgradeable with firmware update. At the moment of writing, only some models with latest firmware support nBase-T and 1 GigE. The FXO series will be the first one to provide this feature.

3.2.2 Bandwidth limitation

With certain computer motherboards / 10 GigE NIC combinations, a reliable data connection might not be possible. Frame drops are the result. To get rid of these frame drops, the 10 GigE interface of the camera does have an adjustable bandwidth limit. Reducing the bandwidth will reduce your maximum frame-rate, obviously. It might be not sufficient to reproduce stable bandwidth, though.

A solution might be a different motherboard / NIC combination together with the latest software and firmware update of your NIC and motherboard manufacturer. Latest firmware versions improve data stability.

Special NICs support 100% connections without frame drops.

3.2.3 Recommended setup

It is recommended to use a 25 GigE card with grabber capabilities. All certification setups are using this kind of cards.

Contact sales@alliedvision.com for details and more recommendations.

- Use high performance PC (such as Intel Core i5 or Core i7 with 16 GB, and mainboard with PCIe Gen 3)
- Use direct NIC-to-camera connections, no switches.

Reliable 25 GigE connections are reported with

- NVIDIA Mellanox ConnectX-5 (Single / Dual port 100 Gb/s Ethernet adapter)
- NVIDIA Mellanox ConnectX-6 (Single / Dual port adapter with support for 200 Gb/s Ethernet)

3.3

Hirose I/O connector

The Hirose™ connector provides power, input and output signal access.

Maximum power output is 2 A.

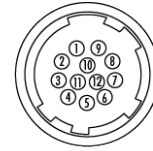

Hirose Pinout

Pin	Signal ECO, ECO2, EVO, HR (CL medium, GigE only)	Signal EXO, FXO, HR (CL De., CXP), SHR	Signal 4 I/O for option ECO
1	V IN- (GND)	V IN- (GND)	V IN- (GND)
2	V IN+ (10 – 25V)	V IN+ (10 – 25V)	V IN+ (10 – 25V)
3	RxD (RS232) not available for PoE versions	IN 4 RxD (RS232)	not connected
4	TxD (RS232) not available for PoE versions	OUT 4 TxD (RS232)	not connected
5	IN 1 (0 – 24 V)	IN 1 (0 – 24 V)	IN 1 (0 – 24 V)
6	IN 2 (0 – 24 V)	IN 2 (0 – 24 V)	IN 2 (0 – 24 V)
7	OUT 1 (open drain)	OUT 1 (open drain)	OUT 1 (open drain)
8	OUT 2 (open drain)	OUT 2 (open drain)	OUT 2 (open drain)
9	IN 3+ (RS422)	IN 3+ (opto IN +)	IN 3 (0 – 24 V)
10	IN 3 – (RS422)	IN 3 – (opto IN –)	IN 4 (0 – 24 V)
11	OUT 3+ (RS422)	OUT 3 (open drain)	OUT 3 (open drain)
12	OUT 3 – (RS422)	OUT 0 (open drain)	OUT 4 (open drain)
	Shielding	Shielding	Shielding

Fig. 3-5: I/O Hirose connector layout

Inputs and outputs connect via in the GenICam software tree to the appropriate actions.

For detailed information about switching lights with the power outputs via GenICam, refer to ["LED strobe control" on page 75](#).

Type	HR10A-10R-12P
Matching connector	HR10A-10P-12S

Table: 3-1: Hirose connector types

Getting started

4.1 Find camera specs

For technical data sheets visit [FAQs und Application Notes](#).

Search for a specific camera, using series and model name or by using the SVCam camera finder. The details and download section provides you with manuals, drawings, as well as software and firmware.

4.2 Power safety

For safety reasons, for protection of the camera and users, use certified power supplies (Low power supply according IEC 62368-1) only. Refer to specifications for your camera model. Appropriate power supplies can be ordered at Allied Vision Gilching GmbH.

The power supply must be easily accessible at all times! For Power specs, refer to the data sheet of your model.

4.3 Connect the camera

When using your own power supply (voltage range 10...25 V DC), see also Hirose 12-pin layout of the power connector (see ["Hirose I/O connector" on page 22](#)). For power input specifications refer to the technical data information on our website.

The external power on the Hirose connector is the preferred power source.

Camera power supply is not powering 4I/O LED lights.

CONNECTING THE CAMERA

The camera does not have a power switch. The camera is powered on as soon power is available to the camera via the Hirose connector or through the interface cables.

- Connect the power supply with the Hirose connector.

DISCONNECTING THE CAMERA

For making sure the camera is not connected to power

- Disconnect Hirose plug from camera
- Disconnect power plug from power AC wall outlet to disable the DC power supply.

4.4 GigE IP setup

GigEVision cameras require a working Gigabit Ethernet network connection.

- Make sure the camera is attached to the network and is powered on.
- Make sure all devices are plugged in and that the firewall settings are not blocking the connection to the camera.

4.4.1 Automatic camera detection

By default, Allied Vision GigE Vision cameras acquire a valid network address via LLA or DHCP from the network, provided the router is set up to distribute accordingly.

Make sure to have valid network protocol with jumbo frames enabled on your host computer (refer to ["Jumbo frames" on page 18](#)).

1. For finding and accessing the camera, start SVCapture on the computer. As soon as the camera has finished booting, the available camera is displayed in the main window.

2. Select the camera and click **OK**.

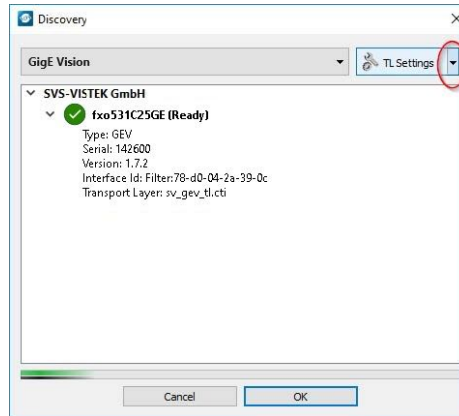

MANUAL CONFIGURATION

Manual IP configuration can be required for the following situations:

- Assigning a unique IP address (make sure the new address valid in the current subnet)
- Saving a specific address as a permanent address of the camera (persistent)
- Saving automatic address mode or the manually configured address of the camera

1. To change automatic address or to go back to automatic mode, configure the IP settings in the drop down menu **TL Settings**.

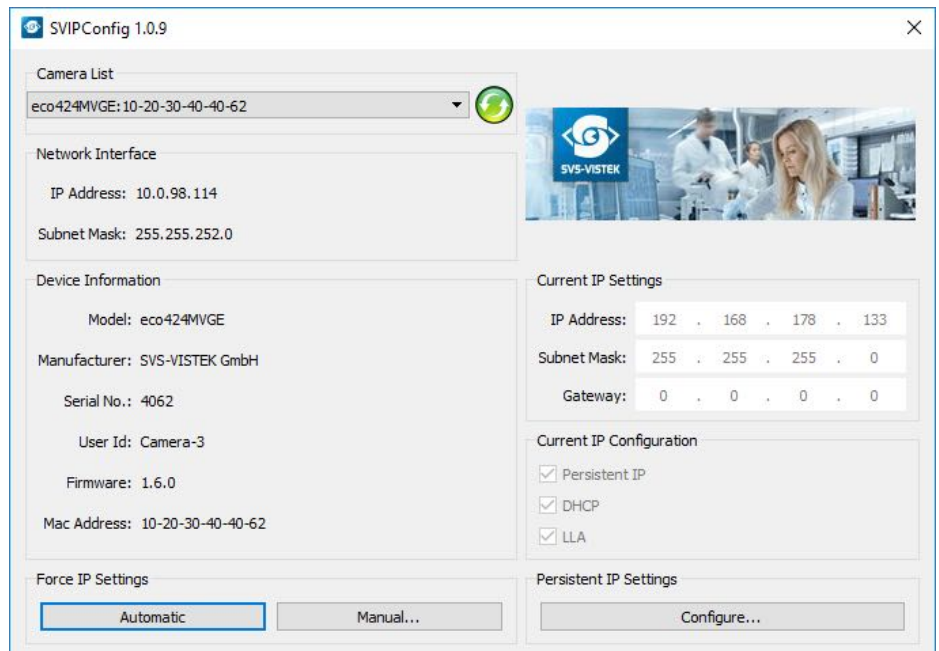

ENABLING A PERSISTENT IP ADDRESS

A persistent IP address is used to always connect the camera with a specific IP address, even when the camera or the network is rebooted, thereby overriding the dynamically assigned IP address in a DHCP network setting.

1. Select **Configure...** in the section "Persistent IP Settings".
2. Enable "Persistent IP Address".

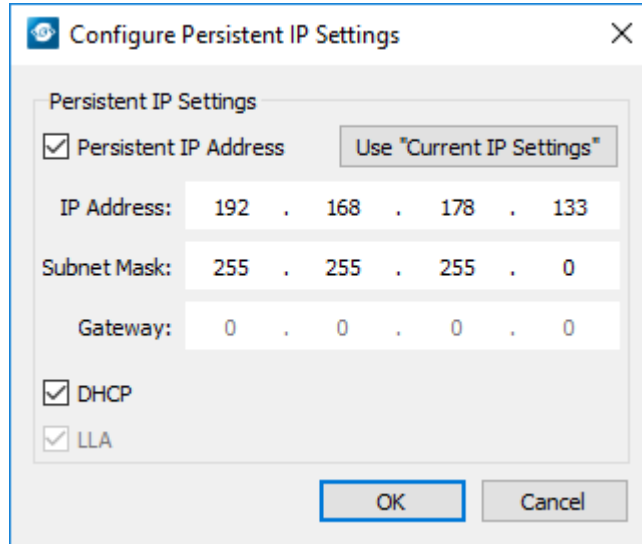

3. For assigning the currently used IP address, select Use "Current IP Settings".
4. To manually assign an IP address, enter the IP address of the camera and the subnet address.

Make sure the IP address is unique within the network.
5. If necessary, provide the network address of the gateway server.
6. Select **OK**.

4.4.2

Frame buffer settings

The frame buffer temporarily stores image data in DDR4 memory before transmitting it via the 25 GigE interface to the computer or processing unit (i.e. receiving device). It helps prevent data loss that might occur when the network or receiving device is busy or slow. By buffering the image data, the frame buffer ensures that any network packet can be re-sent if necessary, increasing the reliability of data transmission.

When the camera operates at its maximum frame rate continuously, the memory bandwidth might not keep up with the network transmission rate, potentially leading to frame loss.

If this occurs, it is recommended to reduce the frame rate or disable the frame buffer by navigating to Transport Layer Control > Use Frame Buffer > Off.

Disabling the frame buffer will prevent the camera from re-sending packets.

To minimize the risk of frame loss during network transmission or at the receiving device, consider the following steps:

- Optimize connection: Ensure that the connection between the camera and the receiving device is optimal. For detailed guidance, refer to "[25 GigE Interface](#)" on page 17.
- Optimize network settings: Adjust the network settings of the receiving device to improve data handling, refer to "[Optimal network adapter settings](#)" on page 27.
- Enable High-Performance Data Transfer: If possible, enable direct memory access in the receiving device to bypass CPU involvement, enhancing data transfer speed and efficiency, see "[Installing the SVGenTLRmax package](#)" on page 28.

4.4.3

Optimal network adapter settings

This whitepaper explains how to configure your network adapter or card, or frame grabber to give the best performance when used with a 1 GigE / 10 GigE / 25 GigE camera.

If the network interface controller (NIC) is not set optimally, it can lead to loss of performance, lost network packets, lost frames, and connection losses.

We recommend inserting the network card or network grabber into the topmost PCIe interface (closest to CPU).

- Make sure using the latest driver for your network adapter.

For Intel network adapters, we recommend the Intel Pro network driver which can be downloaded from the Intel website.

- When using a laptop, operate it with the power supply unit connected. Windows slows down the network speed in battery mode.
- Set the PC to "High Performance" in the Power Options in the Windows Control Panel.
- Open "Control Panel\Network Connections" to see your network devices.
- Right click on your network adapter which is connected to the camera and go to "Properties".

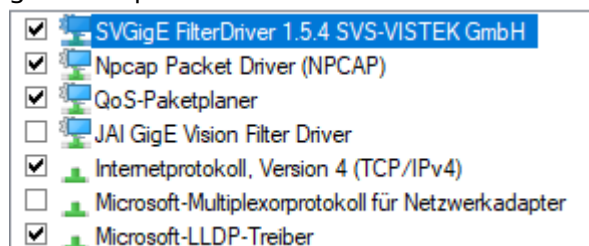

- Disable all unneeded GigE Vision filter drivers.
- Only activate the driver of your software e.g. "SVGigE FilterDriver x.x.x". Additional filter drivers might slow down network speed.

- Go to **Settings > Configure > Performance Options** and set the following parameters:
 - Interrupt throttling: activated
 - Jumbo Packages: 9014 Byte (9K)
 - Max. number of RSS queues: 8 queues (depends on CPU and used Image Acquisition Software) (for low End CPUs lower queues might work better)
 - Receive buffer: 4096 (or the supported maximum)
 - Flow control: RX and TX activated (Intel I219-V and I219-LM Adapter sometimes need Flow Control disabled)
 - Interrupt throttling rate: Adaptive
 - Transmission buffer: 4096 (or the supported maximum)
 - If setting available: Log connection event: deactivated
 - If setting available: Energy-efficient Ethernet: deactivated

- Depending on the network interface card manufacturer, type, and driver version, not all parameters are available.
- On some Systems, disabling the C-States (Power Saving Modes for the CPU) in the BIOS helps improving the system stability.
- We only recommend disabling the firewall for testing / debugging purposes.
- For stability improvements, try setting more specific firewall rules for SVCapture with firewall enabled .

4.4.4

Installing the SVGenTLRmax package

The SVGenTLRmax installer contains the SVGenTL Rivermax Transportlayer, the Rivermax API and the Mellanox card driver (WinOF2). If you have already installed the Rivermax SDK, deselect the component before starting the installation.

We recommend using the versions of our installer and installing the package complete with all components, because this is the version with which we have tested our transport layer.

- Install the SVGenTLRmax installer.
- Place the Rivermax license file (rivermax.lic) into the location “Program files > Mellanox > Rivermax > lib”.

Name	Date modified	Type	Size
dpcp.lib	31/01/2024 19:44	Object File Library	22,747 KB
rivermax.dll	19/07/2023 10:43	Application exten...	1,499 KB
rivermax.lib	31/01/2024 19:47	Object File Library	62 KB
rivermax.lic	28/03/2024 08:07	License	1 KB

SYSTEM CONFIGURATION

After successful installation, set the following network and system settings:

- Deactivate the C-States (CPU-idle mode) in BIOS.
- Navigate to the network adapter properties and set the Jumbo Packet size

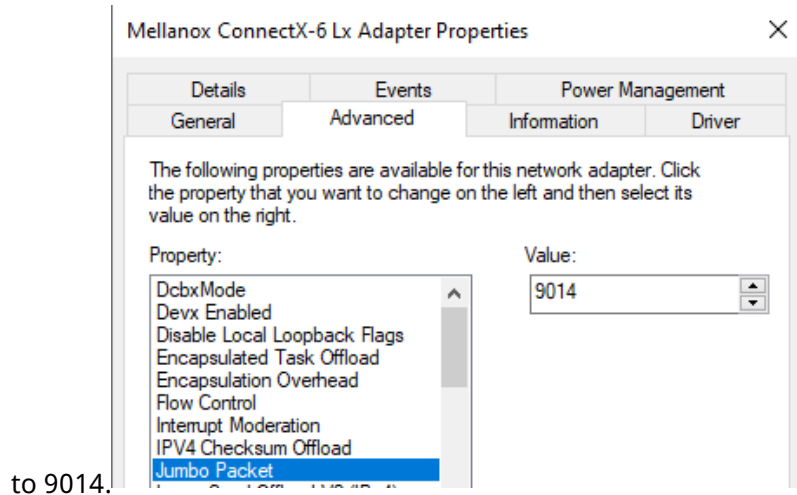

- Increase "Receive Buffers" and "Send Buffers" to 4096:
- Disable the energy saving settings of your system by setting the Power Options to High performance.
- In SVCapture2, navigate to the TL Settings and check that only "Allied Vision GevRMax TL" is enabled.

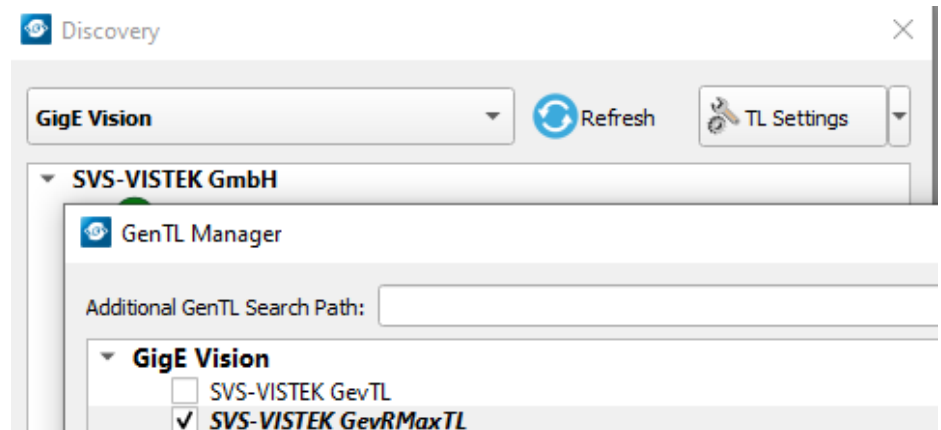

4.5 Cooling

During operation, the heat from the camera's sensor dissipates to the housing. To maintain reliable performance, it is crucial to adhere to the operating temperature range specified in the camera's technical data.

- Install the camera so that the housing openings at the back or at the sides are not blocked and ventilation is possible under all operating conditions.
- Check the unhindered air flow after installation of surrounding components such as cables.

ADDITIONAL COOLING

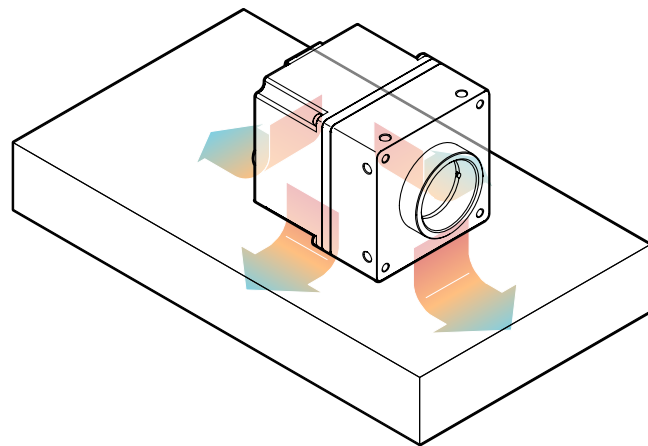

Fig. 4-1: Camera mounted to a heat sink (example)

If the temperature consistently exceeds the maximum operating temperature specified for the camera, additional cooling measures are necessary. This can be achieved by:

- Mounting the camera housing to a heat sink or other heat-dissipating material. For optimal cooling efficiency, ensure that the contact area between the camera housing and the cooling material is as large as possible, allowing for better heat transfer. In addition, vibrations will be minimized within the entire system.
- If available, activating the built-in fan or adjust the fan control threshold.
- If available, activating the built-in thermoelectric cooling feature.
- Using an air- or water-cooling system.

Even if the housing temperature remains below the maximum operating temperature, using additional cooling is recommended to ensure optimal image quality and power efficiency.

4.6

Camera status LED codes

On power up, the camera will indicate its current operation status with a flashing LED on its back. The LED will change color and rhythm.

The meaning of the blinking codes translates as follows:











LED status code	Indication
	nothing connected
	assignment of network address
	network address assigned
	system connected
	streaming channel available
	acquisition enabled
	initialization error
	Camera overheating
	waiting for trigger
	exposure active
	readout / FVAL

Fig. 4-2: Camera status LED codes

Feature description

This chapter covers features of SVCam cameras. Not every feature might be supported by your specific camera model. For information about the features of your specific model, refer to the specifications area of our website with your exact model with our [Camera Selector](#).

5.1 Basic features

5.1.1 Gain

Setting gain above 0 dB (default) is a way to boost the signal coming from the sensor. Especially useful for low light conditions. Setting gain amplifies the signal of individual or binned pixels before the ADC. Referring to photography adding gain corresponds to increasing ISO. Increasing gain will increase noise as well.

add 6 dB	double ISO value
6 dB	400 ISO
12 dB	800 ISO
18 dB	1600 ISO
24 dB	3200 ISO

Table: 5-1: Table of dB and corresponding ISO value

Gain also amplifies the sensor's noise. Therefore, gain should be last choice for increasing image brightness. Modifying gain will not change the camera's dynamic range.



Fig. 5-1: Noise caused by too much gain

AUTO GAIN

For automatic adjustment of gain refer to auto exposure (see ["Auto exposure" on page 46](#)).

When using auto-gain with steps of gain, the non-continuous gain adjustment might be visible in final image. Depending on your application it might be preferable to use fixed gain values instead and modify exposure with exposure time.

5.1.2

Resolution

As mentioned in the specifications, there is a difference between the numerical sensor resolution and the camera resolution. Some pixels towards the borders of the sensor will be used only internally to calibrate sensor values ("Dark pixels"). The amount of dark current in these areas is used to adjust the offset (see ["Offset" on page 33](#)).

For calculating image sizes, the maximum camera resolution is determining maximum image resolution, refer to the specifications of the camera model).

5.1.3

Offset

For physical reasons the output of a sensor will never be zero, even the camera is placed in total darkness or simply closed. Always there will be noise or randomly appearing electrons that will be detected as a signal (dark noise: noise generated without light exposure).

To avoid this dark noise to be interpreted as a valuable signal, an offset will be set.

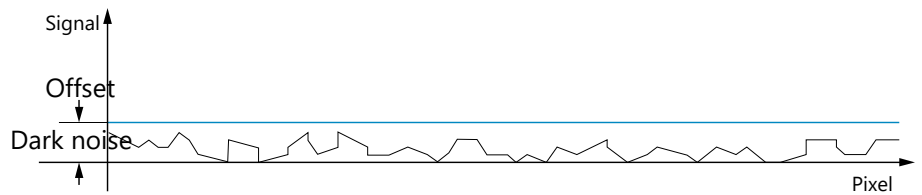

Fig. 5-2: Dark noise cut off by the offset

Most noise is proportional to temperature. The offset is automatically regulated by the camera sensor to compensate for the surrounding temperature changes by referencing specific pixels as „black“, i.e. never exposed to light. So the offset will be set dynamically and conditioned to external influences.

The offset can be limited by a maximum bit value. If higher values are needed, try to set a look up table.

5.1.4

Color

Color cameras are identical to the monochrome versions. The color pixels are transferred in sequence from the camera, in the same manner as the monochrome, but considered as “raw”-format.

The camera sensor has a color mosaic filter called “Bayer” filter pattern. The pattern alternates as follows:

- First line: GRGRGR... (R=red, B=blue, G=green)
- Second line: BGBGBG...

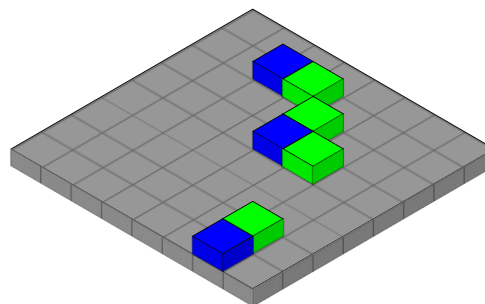

Fig. 5-3: Example of Bayer pattern (source: wikipedia)

Note that about half of the pixels are green, a quarter red and a quarter blue. This is due to the maximum sensitivity of the human eye at about 550 nm (green). De-Bayering is not done in the camera, it must be done in the client software. Not all sensors have the same sequence of color. The GenICam property **PixelColorFilter** indicates the sequence of the color pixels when reading color images.

Using color information from the neighboring pixels the RG and B values of each pixel is interpolated by software, e.g. the red pixel does not have information of green and blue components. The performance of the image depends on the software used. Due to this, physical resolution of color cameras is always lower than resolution of monochrome cameras.

Camera Link frame grabbers need information of the sequence order of the colors. The order depends on sensor type. USB3 and GigE cameras provide this in their XML file.

It is recommended to use an IR cut filter for color applications

Industrial vision cameras are not intended to display colors according to human perception.

WHITE BALANCE

The human eye adapts to the definition of white depending on the lighting conditions. The human brain will define a surface as white, e.g. a sheet of paper, even when it is illuminated with a bluish light.

White balance of a camera does the same. It defines white or removes influences of a color-based on a non-white illumination.

- **Continuous:** Auto white balance will analyze the taken images and adjust exposure per color accordingly as long as the camera is taking images. Different colors of the same object in a sequence might be the result depending on the other objects in the image
- **Once:** Auto white balance will adjust white balance as soon it is started and will stop modifying parameters as soon white balance is finished.

COLOR CALIBRATION

The color cameras are delivered without color calibration.

If a color calibration is necessary e.g., because the image has a green cast, the color can be adjusted with a white balance.

The feature "White Balance" is part of the camera firmware and can be operated with a GenICam compliant software.

1. When using SVCapture 2, select **Guru** as **Feature Mode**.

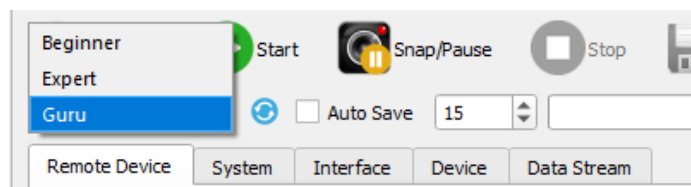

2. Select **BalanceWhiteAuto** in **Analog Control** in the GenICam feature tree.

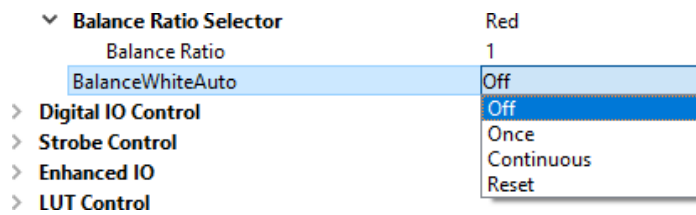

The White Balance "Continuous" mode is only recommended in a slow triggered mode. Usually, it is sufficient to perform a white balance once with the given lighting.

3. Use a white, not too dark, but not overexposed surface (white wall or paper) as image. Only then the white balance algorithm can calibrate the color optimally.
4. If unsuccessful, adjust the RGB values manually e.g., by adjusting the green value downwards.
5. After calibration, save the settings in the camera (User Set Save) so that the color correction is preserved after a camera restart.
6. Use a white, not too dark, but not overexposed surface (white wall or paper) as image. Only then the white balance algorithm can calibrate the color optimally.
7. If unsuccessful, adjust the RGB values manually e.g., by adjusting the green value downwards.
8. After calibration, save the settings in the camera (User Set Save) so that the color correction is preserved after a camera restart.

5.1.5 Image flipping

Images can be mirrored horizontally or vertically. Image flip is done inside the memory of the camera, therefore not increasing the CPU load of the PC.

Image flipping is referred to in the GenICam specifications and hence in the software as follows:

- Reverse X: Flips the image along the Y axis horizontally, hence "Horizontal flipping"
- Reverse Y: Flips the image along the X axis vertically, hence "Vertical flipping"



Fig. 5-4: Original image



Fig. 5-5: Horizontal flip



Fig. 5-6: Vertical flip

5.1.6

Binning

Binning provides a way to enhance dynamic range, but at the cost of lower resolution. Binning combines electron charges from neighboring pixels directly on the chip, before readout.

On CMOS sensors, binning will not affect image quality. In any case, binning will reduce the amount of pixel data to be transferred.

The selected binning value describes the number of combined photosensitive cells, where the following value settings apply:

- Value 1 equals the value *Binning Off* from previous versions.
- Value 2 equals the previous value *Binning On* (combination of 2 cells).
- Additionally, value 4 combines four cells horizontally or vertically.

Binning is now solely executed in the image processing chain of the FPGA and never in the sensor.

Furthermore, it is possible to set the binning mode between *Average* or *Sum*:

- Average: The response from the combined cells will be the average value (Value: 0)
- Sum: The response from the combined cells will be added (Value: 1)

VERTICAL BINNING

Accumulates vertical pixels.

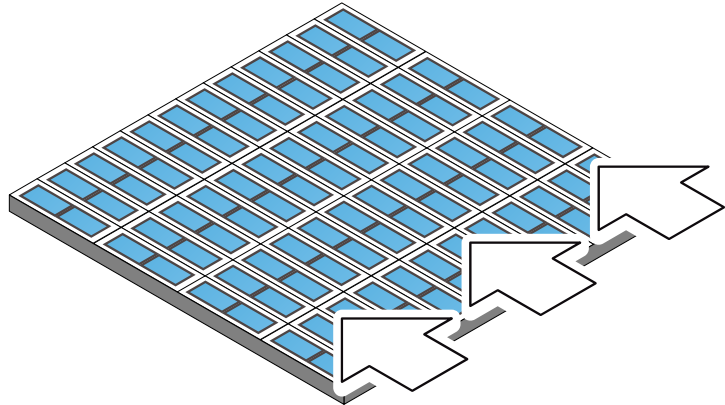

Fig. 5-7: Vertical binning

HORIZONTAL BINNING

Accumulates horizontal pixels.

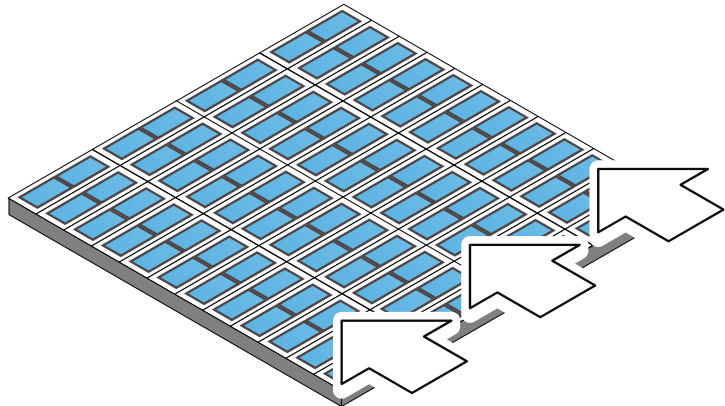

Fig. 5-8: Horizontal binning

2×2 BINNING

A combination of horizontal and vertical binning.

When DVAL signal is enabled only every third pixel in horizontal direction is grabbed.

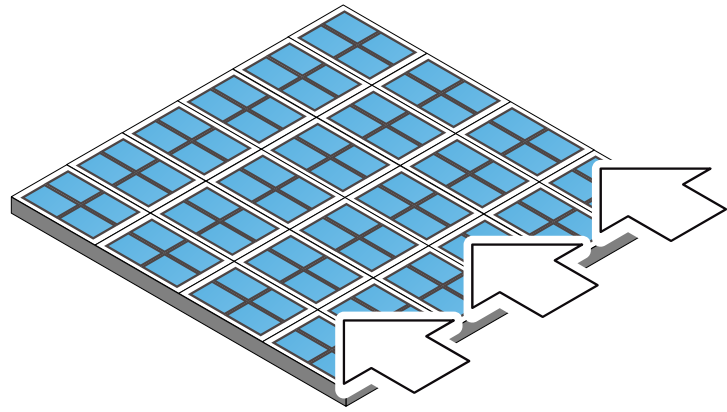

Fig. 5-9: 2x2 binning

5.1.7

Decimation

For reducing width or height of an image, decimation can be used. Columns or rows can be ignored.

For reducing data rate by reducing the region you are interested in, refer to **"ROI / AOI" on page 63**.



Fig. 5-10: Horizontal decimation



Fig. 5-11: Vertical decimation

5.1.8

GenICam

The GenICam standard provides a generic programming interface to control all kinds of cameras and devices. Regardless of the interface technology (GigE Vision, USB 3 Vision, CoaXPress, Camera Link, etc.) or implemented feature, the application programming interface (API) will always be the same. The SNFC makes sure the feature names are similar throughout the manufacturers, making it more easy to switch camera models.

The GenICam™ standard consists of multiple modules according to the main tasks to be solved:

- GenApi: configuring the camera
- SNFC: Standard Feature Naming Convention, a catalog of standardized names and types for common device features
- GenTL: transport layer interface, grabbing images
- GenCP: generic GenICam control protocol
- GenTL SFNC: recommended names and types for transport layer interface.

The GenICam properties are organized as a tree. Manufacturers can add more features.

With your SVCam, the GenICam tree does have some hardware related extensions, especially in the I/O sector. See the Quick guide install for a short introduction into the Allied Vision GenICam tree.

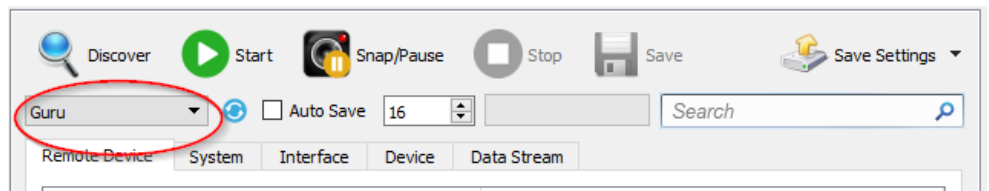

The GenICam properties are organized in views. The recommended way to view and adjust is by using SVCapture. If you want to have a full view of all adjustable GenICam items, activate the Guru mode. Beginner mode will show only most common attributes.

All modifications in the GenICam tree will have immediate effect.

5.1.9

Trigger modes

To start capturing images, the camera has to receive a trigger signal. This trigger signal can be a software trigger, it might be an electric signal on the hardware I/O or it can be a timed trigger (sequence of images or ["Precision Time Protocol" on page 70](#)).

SOFTWARE TRIGGER

The camera exposure can be started via software. With some interface types like GigE and USB3 it is impossible to have a 100% precise software trigger. CoaXPress and Camera Link permit relatively precise triggering of the camera. If you need to have a precise trigger, we recommend the usage of an ["External hardware trigger" on page 42](#).

EXTERNAL HARDWARE TRIGGER

External trigger with programmable exposure time. In this mode the camera is waiting for an external trigger pulse that starts integration, whereas exposure time is programmable via the serial interface and calculated by the internal microcontroller of the camera.

Default input for trigger is Input1.

At the rising edge of the trigger the camera will initiate the exposure.

The software provided by Allied Vision lets the user set exposure time e.g. from 60 μ s to 60 sec (camera type dependent).

Exposure time of the next image can overlap with the frame readout of the current image (trigger pulse occurs when FVAL is high). When this happens, the start of exposure time is synchronized to the negative edge of the LVAL signal (see figure)

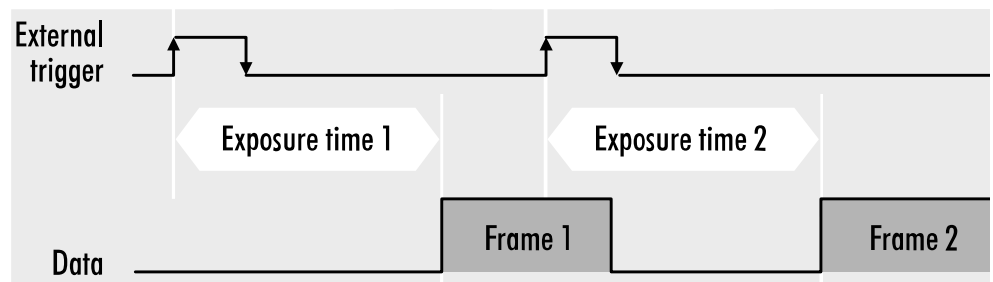

Fig. 5-12: Mode 2: External trigger with programmable exposure time (overlap)

When the rising edge of trigger signal occurs after frame readout has ended (FVAL is low), the start of exposure time is not synchronized to LVAL and exposure time starts after a short and persistent delay.

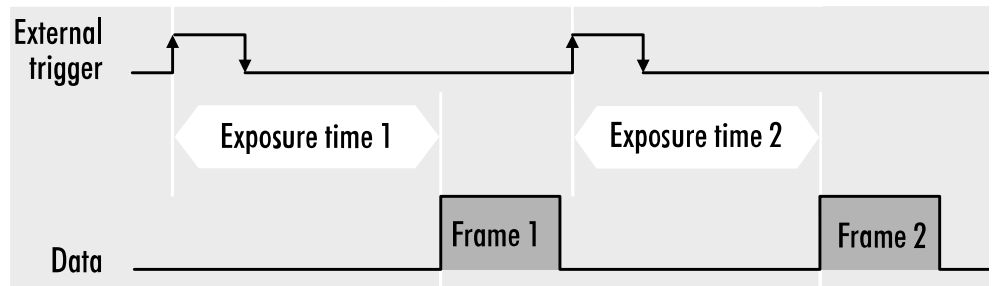

Fig. 5-13: Mode 2: External trigger with programmable exposure time (non overlap)

Exposure time can be changed during operation. No frame is distorted during switching time. If the configuration is saved to the EEPROM, the set exposure time will remain also when power is removed.

DETAILED INFO OF EXTERNAL TRIGGER MODE

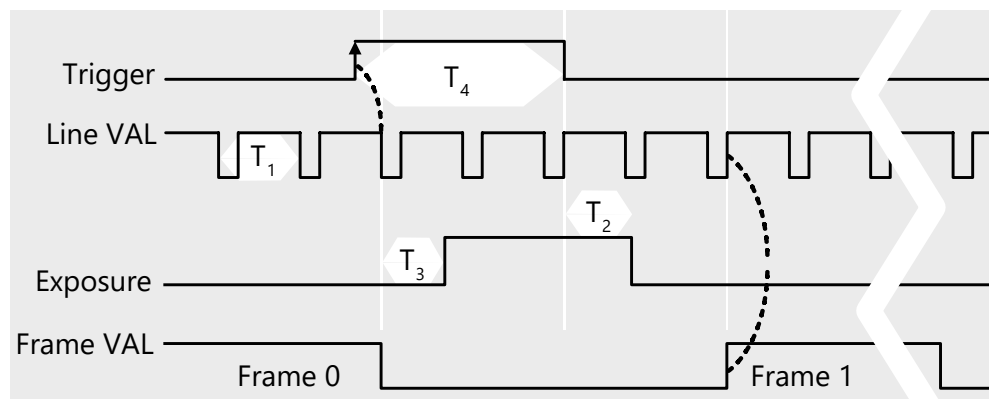

Fig. 5-14: Mode 1: External trigger with pulse width exposure control (overlap)

T₁ Line duration	T₂ Transfer delay
T₃ Exposure delay	T₄ Min. trigger pulse width

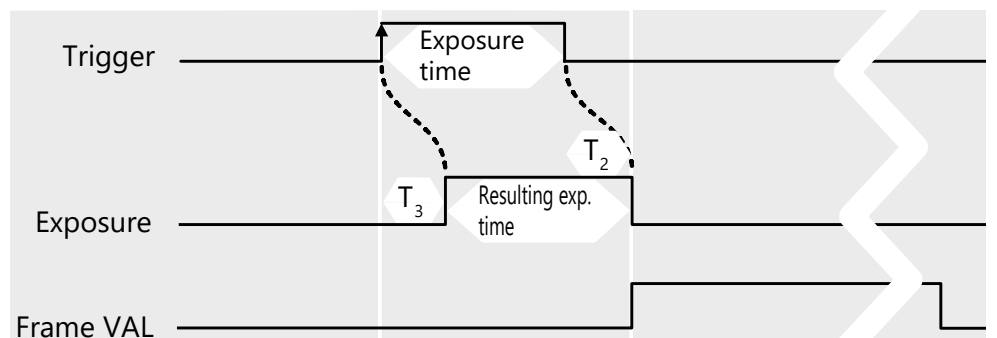

Fig. 5-15: Mode 1: External trigger with pulse width exposure control (non-overlap)

T₂ Transfer delay	T₃ Exposure delay
-------------------------------------	-------------------------------------

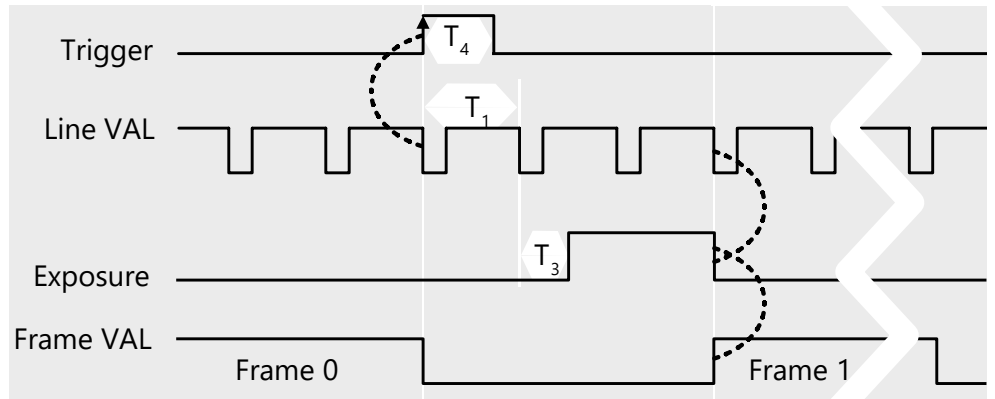

Fig. 5-16: Mode 1: External trigger with programmable exposure time (overlap)

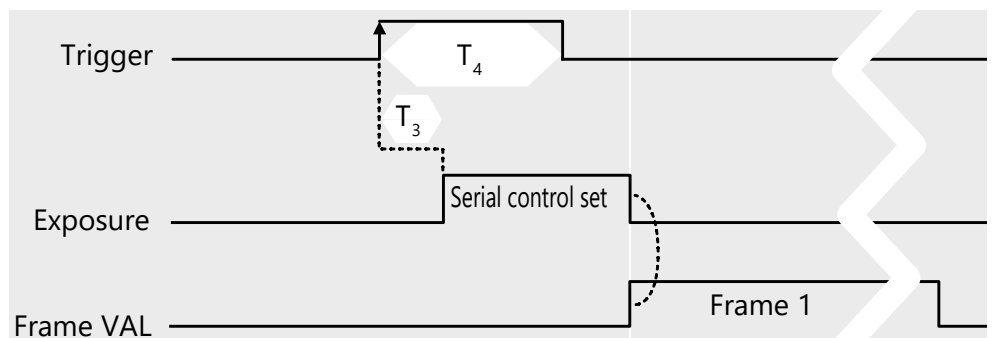
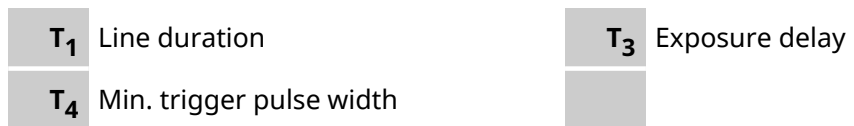

Fig. 5-17: Mode 1: External trigger with programmable exposure time (non-overlap)



5.1.10

Shutter modes

CMOS area cameras consist of pixels, ordered in lines and columns. All pixel are exposed to light and then read out to camera electronics.

GLOBAL SHUTTER MODE

- Global reset of all pixels
- All pixels start light integration at the same time
- All pixels stop integration at same time
- Readout line by line after exposure of whole frame is completed

5.1.11

Exposure

- For various exposure and timing modes, refer to "[Basic capture modes](#)".
- For combining various exposure timings with PWM LED illumination, refer to "[Sequencer](#)" on page 78.

SETTING EXPOSURE TIME

Exposure time can be set by width of the external or internal triggers or programmed by a given value.

5.1.12

Exposure speed

Frames per second, or frame rate describes the number of frames output per second (1/ frame time). Especially GigE and USB cameras cannot guarantee predictable maximum frame rates with heavy interface bus load.

Maximum frame rate might depend on:

- Pixel clock
- Image size
- Tap structure
- Data transport limitation
- Processing time

REDUCING THROUGHPUT TRANSMISSION SPEED

The throttling of the transmission speed is an SNFC-compliant packet-based traffic shaping and allows e.g. the connection of several cameras to one switch.

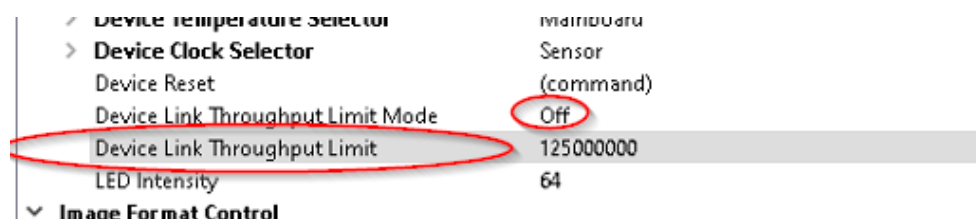

> Device Temperature Selector	mainboard
> Device Clock Selector	Sensor
Device Reset	(command)
Device Link Throughput Limit Mode	Off
Device Link Throughput Limit	125000000
LED Intensity	64
> Image Format Control	

If the data rate resulting from the frame rate exceeds the throttle data rate with activated throttling, the 10 GigE interface automatically enters starts filling the memory. The large internal memory allows the camera to buffer many images. But as soon as the memory is full, frame drops are the result.

5.1.13 Auto exposure

Auto Luminance or auto exposure automatically calculates and adjusts exposure time and gain, frame-by-frame.

The auto exposure or automatic luminance control of the camera signal is a combination of an automatic adjustment of the camera exposure time (electronic shutter) and the gain.

The first priority is to adjust the exposure time and if the exposure time range is not sufficient, gain adjustment is applied. It is possible to predefine the range (min / max-values) of exposure time and of gain.

The condition to use this function is to set a targeted averaged brightness of the camera image. The algorithm computes a gain and exposure for each image to reach this target brightness in the next image (control loop). Enabling this functionality uses always both – gain and exposure time.

LIMITATIONS

As this feature is based on a control loop, the result is only useful in an averaged, continuous stream of images. Strong variations in brightness from one image to next image will result in a swing of the control loop. Therefore it is not recommended to use the auto-luminance function in such cases.

5.1.14 Acquisition and processing time

The camera has to read the sensor, process the data to a valid image and transfer this to the host computer. Some of these tasks are done in parallel. This implies the data transfer does not end immediately after end of exposure, as the image has to be processed and transferred after exposure.

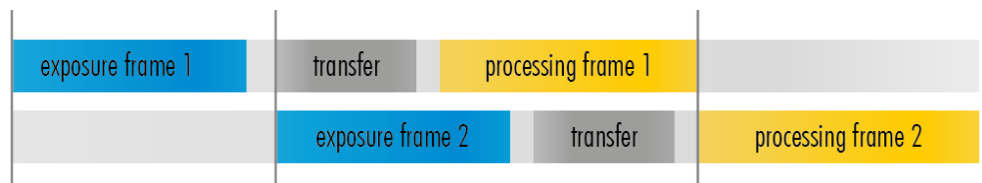

Fig. 5-18: Acquisition and processing time

On the other hand, while processing and transferring the image the sensor might capture already the next frame.

5.1.15 Bit depth

Values of brightness are internally represented by numbers. The number of bits for brightness representation is limiting the number of color values that can be represented. Bit depth defines the maximum unique colors or gray levels in an image.

No of gray values = $2^{\text{bit depth}}$

All SVCam models support 8-bit format. In most cases, the sensor itself is limiting maximum bit depth. Refer to specifications whether your model is supporting higher bit depth.

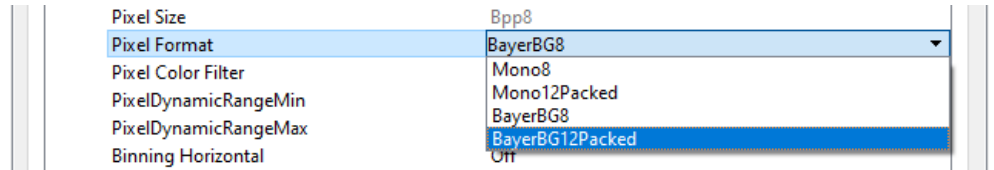

Depending on camera model, different bit depths are supported.

PACKED FORMAT

Some camera models support “packed” bitformats. Instead of using 16 bit per pixel (and transferring a lot of zeroes), 2 bytes contain more information than only 1 pixel.

For example, in the image above, “Mono12Packed” is supported. Every pixel has a bit depth of 12 bit. Information transfer has to be in 8-bit steps (8, 16, 24 etc). By packing, 2 pixel can be transferred in 3 bytes (24 bit) instead of 2 x 16 bit (4 bytes). This increases bandwidth by 25%. This packing does not affect image quality, but the image needs to be unpacked (with an SVCam SDK function, very fast) after image acquisition before the image can be processed.

Unpacking has to be done manually, this is not a GenTL function. Thus, image acquisition in packed formats won't be supported by most 3rd party software products.

SEPARATED BIT DEPTH OF SENSOR AND CAMERA

Some camera models are supporting separated bit depth adjustment of sensor readout and camera readout. Thus you can read in an image e.g. in 12 bit from the sensor, apply a 12-to-8 bit look-up table and read from the camera as an 8 bit image.

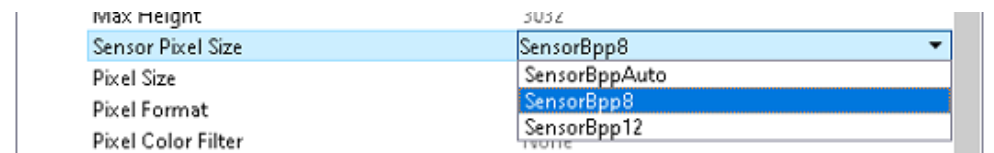

By default, sensor pixel size is "SensorBppAuto" and should follow the adjustment of pixel size.

The final bit depth exported by the camera (camera readout) is adjusted with pixel size.

BIT DEPTH AND BRIGHTNESS WITH SONY GEN 4 SENSORS

The FXO series 25GigE shows different brightness when switching between 8-bit and 12-bit mode (SensorPixelSize). If you read sensor 8-bit, the upper 4 bits of the sensor range are cut off.

8-bit mode sensor pixel size is 50 % faster, but the (bit-cut-off) reduced full well capacity also results in a higher noise percentage. To use the full dynamic range of the sensor, the sensor must be read out 12-bit, the transmission can then be done with (reduced) 8- or 12-bit, as required.

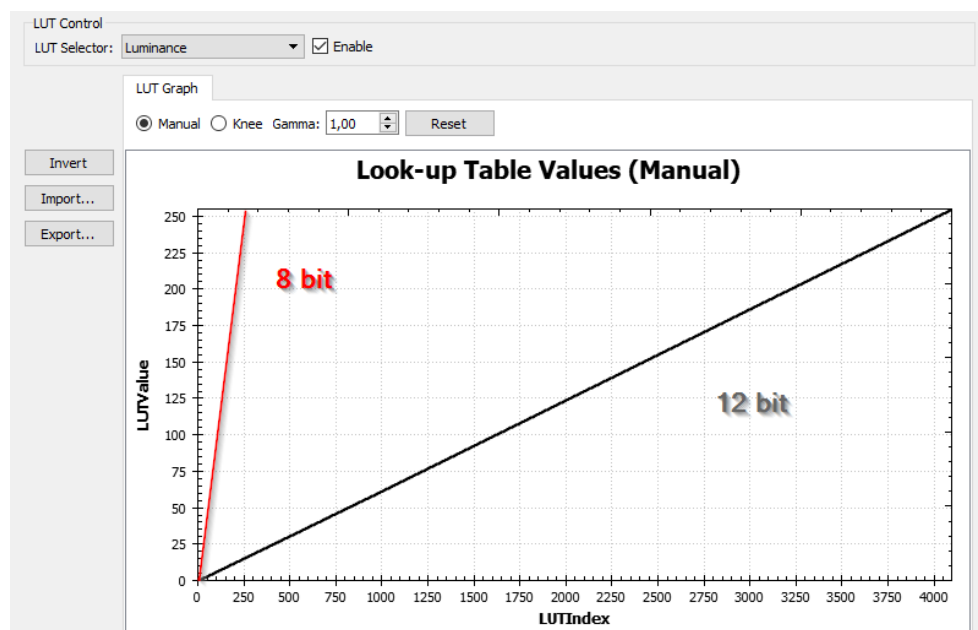

Fig. 5-19: Bit depth and brightness with Sony Gen 4 sensors

The red 8-bit curve above is the result of the sensor 12-bit capacity with the used 8-bit range. The black 12 bit curve is an applied linear 12-to-8 bit look-up table.

fxo541 resolutions and bit depth

The fxo541XGE has different resolutions with different bit depths.

- pixel format mono8: 4504x4504
- pixel format mono12: 4480x4504

5.2 Camera features

The features of the Allied Vision cameras are defined by the combination of its electronics and firmware features. Firmware features can be upgraded with new firmware releases.

5.2.1 Glass filter

The camera is equipped with a glass filter for sensor protection reasons (dust). Optical length of the glass filter is included in the mount specifications.

5.2.2 Shading correction

OVERVIEW

The interactions between objects, illumination, and the camera lens might lead to a non-uniform flat-field in brightness. Shading describes the non-uniformity of brightness from one edge to the other or center towards edge(s).

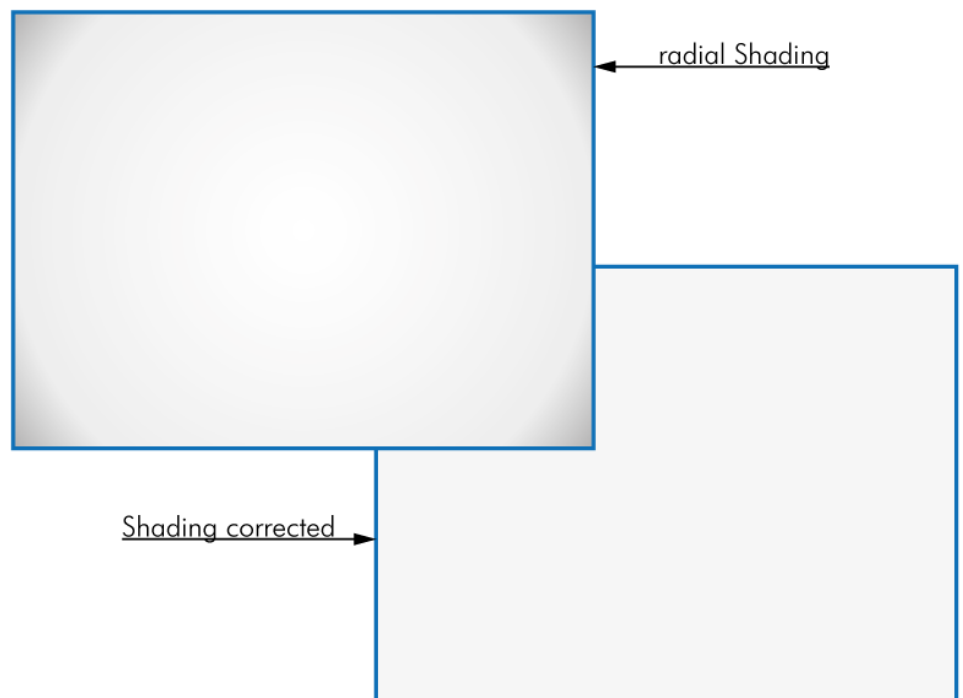

Fig. 5-20: Original and shading corrected image

This shading can be caused by non-uniform illumination, non-uniform camera sensitivity, vignetting of the lens, or even dirt and dust on glass surfaces (lens).

Shading correction is a procedure to create a flat-field image out of a non-uniform image regardless of the reasons of the non-uniformity. Before doing shading correction, make sure your lens is clean and in perfect condition. If the lens is not clean or the lighting not uniform, the algorithm tries to compensate these as well, resulting in a wrong shading table and visible artifacts, loss of details, or local noise in the final image.

In theory, there are several locations of shading

- In the host computer: significant loss of dynamic range
- In the camera, digital: better (smoother) shading than on computer, still loss of dynamic range
- In the camera, analog: set gain / offset locally direct on sensor to get optimum shading correction with only small changes in dynamic range

Shading correction might reduce the dynamic range of the images. By using different gains and offsets on the sensor local noise might be less uniform. Structures in the reference image might lead to visible shading artifacts.

HOW IT WORKS

The tool will divide the image into squares of 16x16 pixel. Out of every 16x16 pixel cluster a set of shading values consisting of specific gain and offset per cluster is calculated. The resulting map can be uploaded into the camera and will compensate for any shading, lens-based or based on illumination.

CREATING A SHADING MAP

Shading maps are test files containing a description for the camera how to balance shading control. Shading maps can be created and uploaded to the camera with SVCapture. The shading map creation process takes any image with any illumination and creates a shading map out of it. This shading map will be uploaded into the camera afterward.

1. Connect the camera to the PC and open it with SVCapture2.
2. Make a picture in which you can see the vignetting (shading).

Check that the image is not over-exposed and AOI and Binning is disabled.

3. In **Shading Correction > Control**, enable or disable shading correction.
4. In **Shading > Shading Map Selector** select a shading map.



5. Open **Assistant > Shading Correction** and select **Generate Map....**
6. Add the *.bmp file to the shading map generator.



7. Select **Generate map**. The map is saved in the background.
8. After the map is successfully created, upload the map in the camera by selecting **Upload map to camera**.
9. Select **Yes** for saving the map in the user set.

Shading correction is possible with certain models only. See camera specs whether your model does support this. In case your camera is not supporting, the assistant will not be selectable.

1. Take shading reference images with shading correction disabled (use 16 images minimum) and save the to the local hard drive. As file format, use .bmp files with more than 8 bit.
2. Start **Assistants > Shading Correction > Generate Map**.

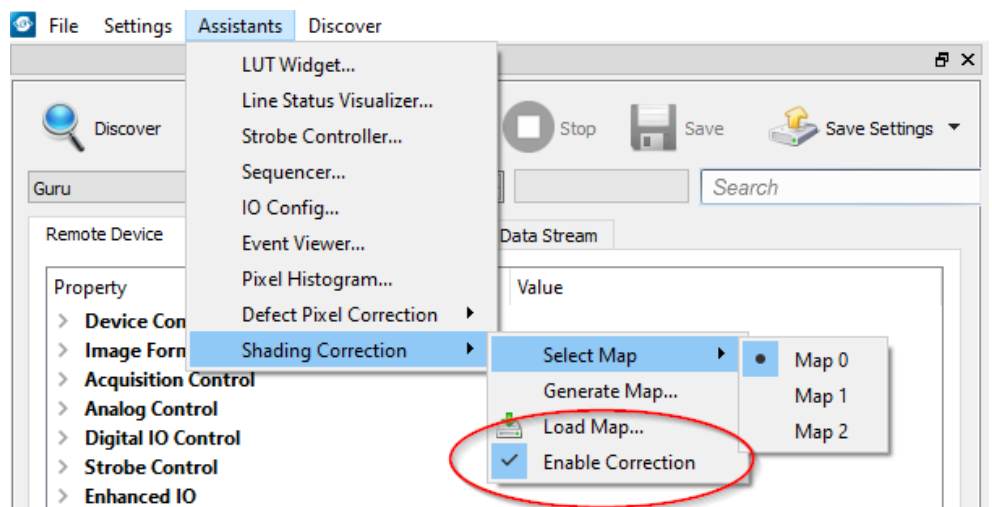
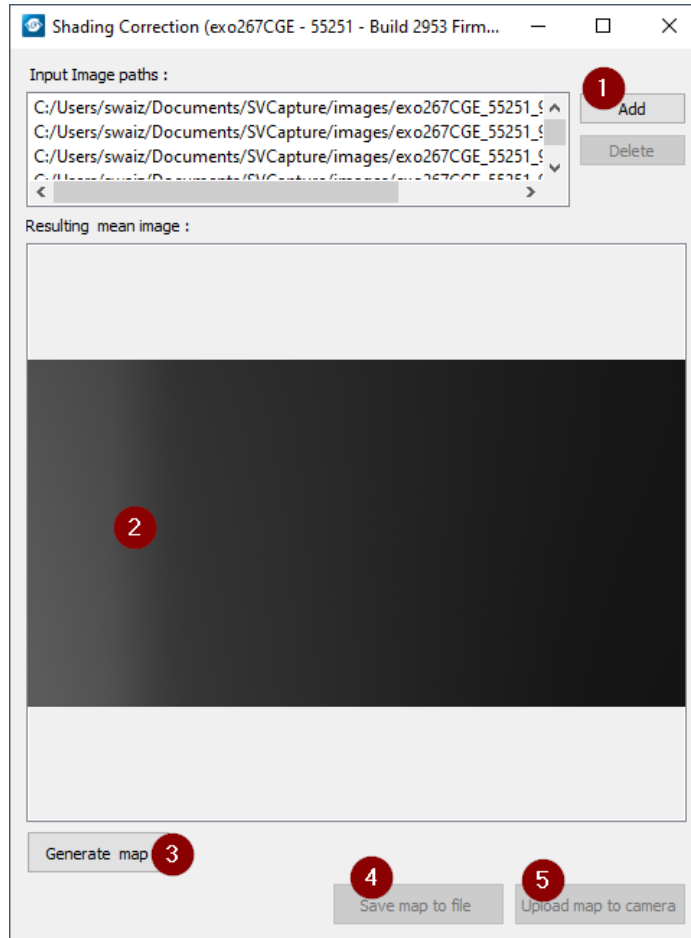
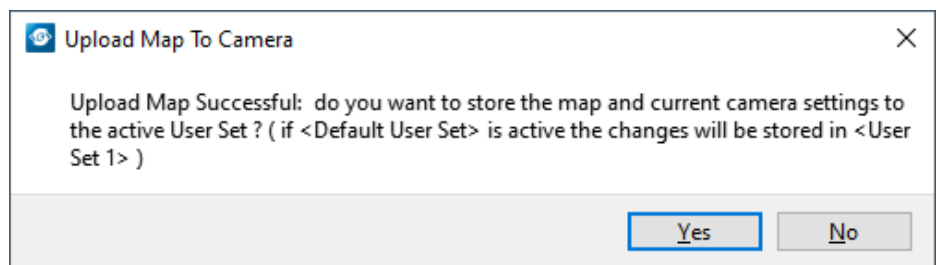

Fig. 5-21: Shading control disabled

3. Load the reference images.



4. Observe the shading in the preview (2).
5. Select **Generate map** (3) to create the shading map.
6. Select **Save map to file**. This file can be used in programmed environments via SDK as well.
7. Select **Upload map to camera** and check the result. If the lighting did not change from start of procedure, you should see a uniform image with enabled shading control.



- Run the camera with same lighting to see corrected image.

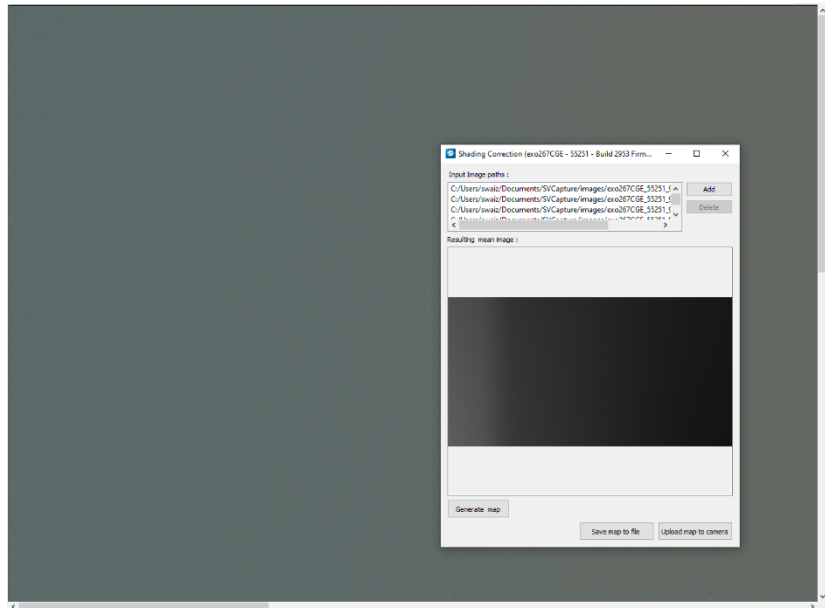

SHADING CORRECTION WITH SVCAPTURE2

- Connect the camera to the PC and start SVCapture2 (version 2.5.3 or higher is required).
- Disable AOI and binning.

FOR CAMERAS WITH GIGE, USB3, OR CXPX

- Take a picture with vignetting (shading) clearly visible. Make sure that the image is not overexposed.
- Save the image as a BMP file.

USING SVCAPTURE

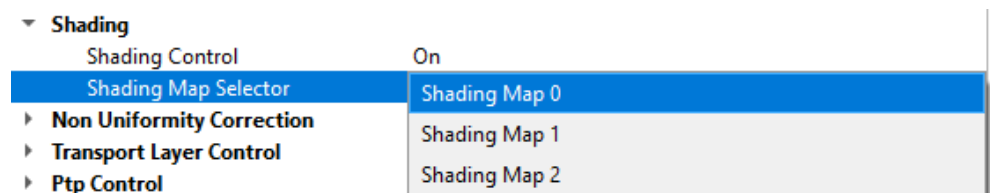

- Open **Shading** in the Genicam tree.
- Select **Shading Control** to enable the shading correction.
- Select **Shading Map Selector**, and choose a shading map.

4. Open **Defect Pixel Correction** in the **Assistant**.

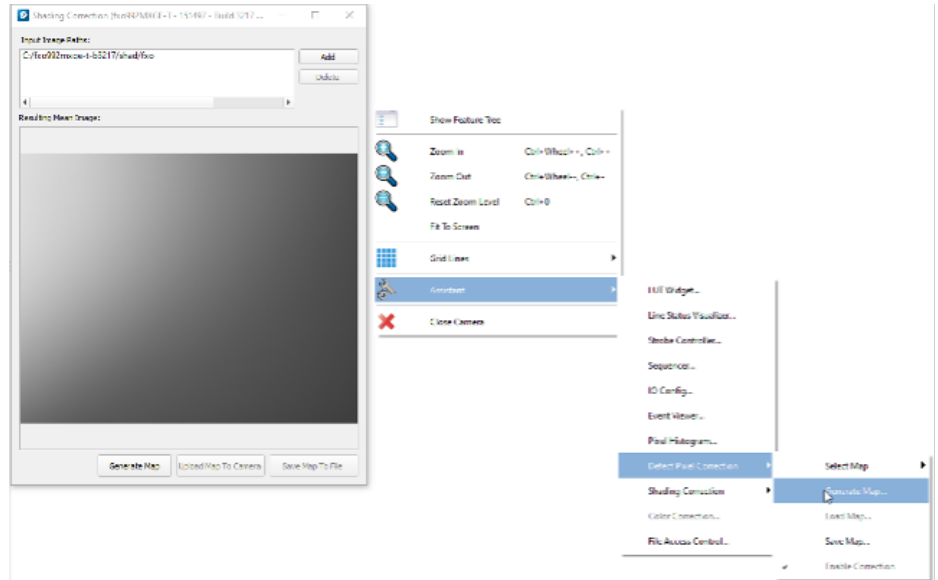

5. Select **Generate Map**.
6. Select **Add** in the shading map generator and add one or more images.
7. Select **Generate Map** and wait until the map is generated successfully. The map is saved in the background.
8. To upload the map to the camera, select **Upload Map to Camera**.
9. Select **Yes** to save the map in the user set.

DELETE A SHADING MAP IN SVCAPTURE2

The shading map can be deleted via the register address.



1. Open **Debug** in SVcapture2.
2. Set the **RegisterValue(DEC)** to "1" to delete the shading.
3. After deletion, set the **RegisterValue(DEC)** to "0" and save the settings in the **User Set** control.

DELETING THE SHADING CORRECTION MAP BY OVERWRITING

1. To delete the shading correction map, open the Shading Correction Generator.
2. Select **Save Map to File** and open the file using a spreadsheet application.
3. Overwrite the values with "1.00000".

4. Open **Defect Pixel Correction** the **Assistant** and select **Load Map....** The values in the shading correction map are overwritten with the values from the uploaded file.

5.2.3

Defect pixel correction

All image sensor have defect pixels in a lesser or greater extent. Type and number of defects determine the quality grade (quality classification) of the sensor.

Defect pixel correction is using information from neighboring pixels to compensate for defect pixels or defect pixel clusters (cluster may have up to five defect pixels).

Defect pixels can either be dark pixels, i.e. that don't collect any light, or bright pixels (hot pixel) that always are outputting a bright signal.

The amount of "hot" pixels is proportional to exposure time and temperature of the sensor.

By default, all known defect pixels or clusters are corrected as a factory default.

Under challenging conditions or high temperature environments defect pixel behavior might change. This can be corrected.

- A factory created defect map (Allied Vision map), defying known defects, is stored in the camera.
- A custom defect map can be created by the user. A simple *.txt file with coordinates must be created. The user must locate the pixel defects manually.
- The *.txt file can be uploaded into the camera. Beware of possible Offset!
- Defect maps can be switched off to show all default defects, and switched back on to improve image quality.

Unlike shading correction, defect pixel correction suppresses single pixels or clusters and reconstructs the expected value by interpolating neighboring pixel values. The standard interpolation algorithm uses the pixel to the left or to the right of the defect. This simple algorithm prevents high run-time losses.

More sophisticated algorithms can be used by software.

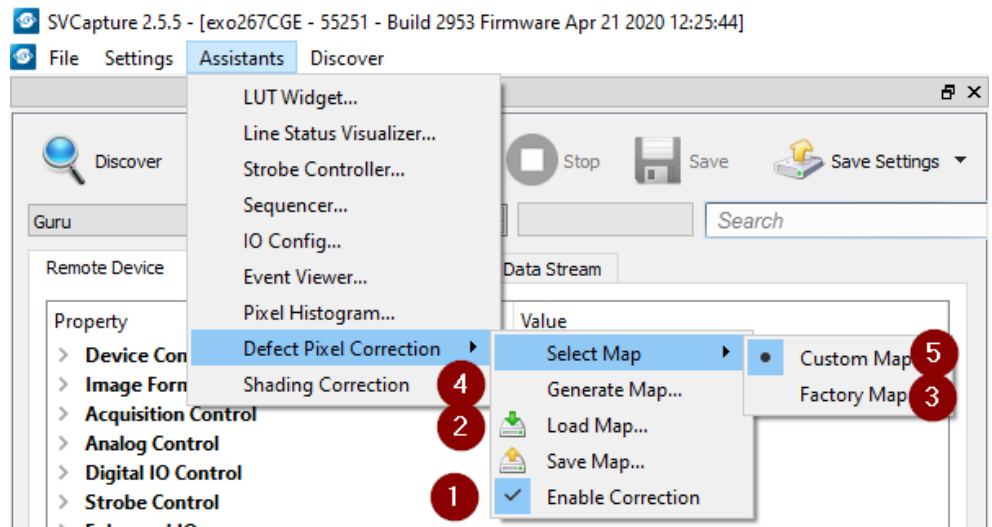

Fig. 5-22: Illustration of a defect pixel

PROCEDURE OF PIXEL CORRECTION

SVCapture is the tool to generate pixel correction maps. The pixel correction assistant provides everything to create, load, enable and restore defect pixel creation maps.

Defect pixel correction is possible with certain models only. See camera specs whether your model does support this. In case your camera is not supporting, the assistant will not be selectable.



- For easy image processing, it is recommended to have pixel correction activated
- Pixel correction maps can be saved and loaded
- The std factory map can be selected any time
- Generate your own custom map
- Select your own defect pixel map

The procedure to create a std map is pretty straight forward. Before starting generating the map, in the GenICam tree do the following:

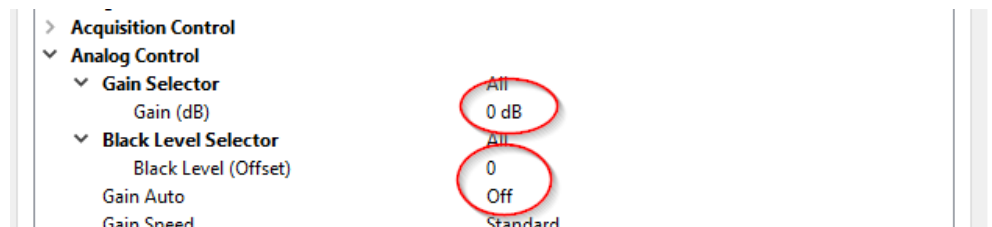

1. Set gain to "0 dB".
2. Disable **Gain Auto**.
3. Set **Offset** to "0".
4. Record a set of dark images with the lens cap on.

DEFECT PIXEL MAP GENERATION

1. Save a completely dark image as bmp file.

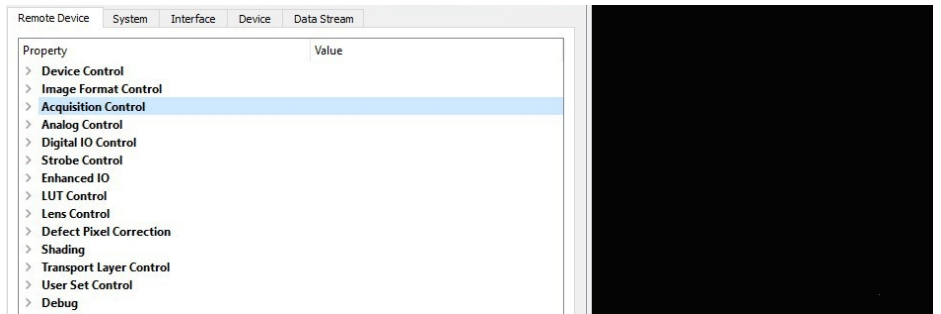

2. Save a completely white image as bmp file.

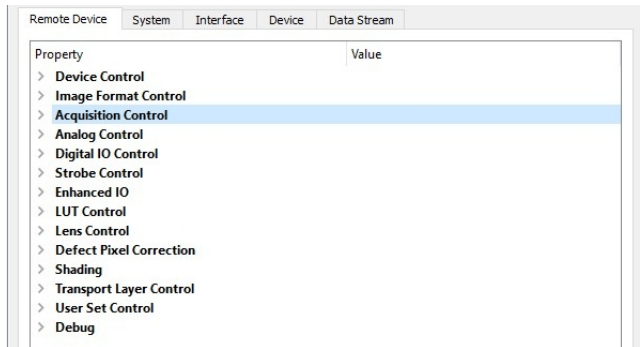

3. Open **Assistant > Defect Pixel Correction > Select Map > Custom Map.**
4. Select **Generate Map....**
5. Add a "Dark Image".

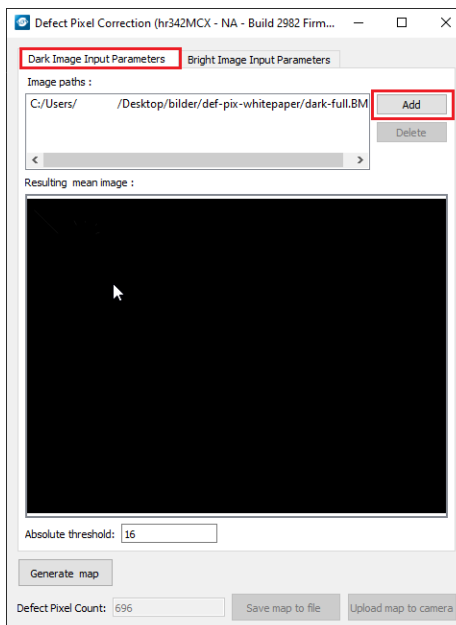

6. Add a "Bright Image".

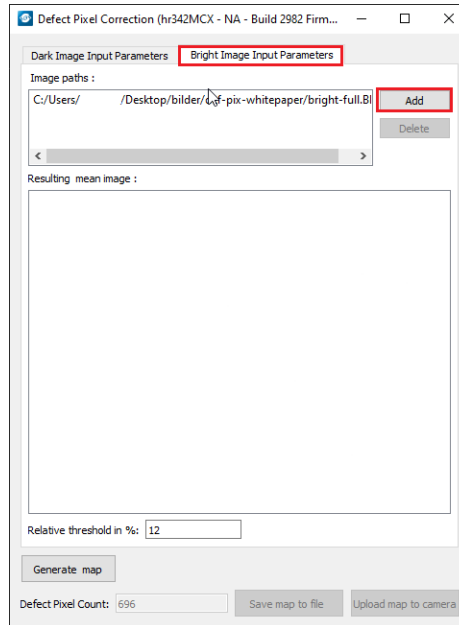

7. Select **Generate map**.

8. Observe how many defect pixel were detected in the "Defect Pixel Count".

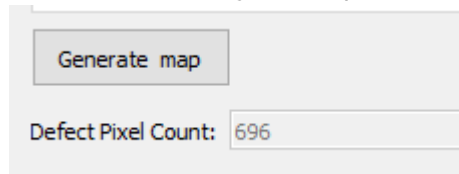

9. Select **Upload map to camera**.

5.2.4

Look-up table

The look-up table feature (LUT) lets the user define certain values to every bit value that comes from the ADC. To visualize a LUT a curve diagram can be used, similar to the diagrams used in photo editing software.

The shown custom curve indicates a contrast increase by applying an S-shaped curve. The maximum resolution is shifted to the mid-range. Contrasts in this illumination range is increased while black values will be interpreted more black and more of the bright pixels will be displayed as 100 % white.

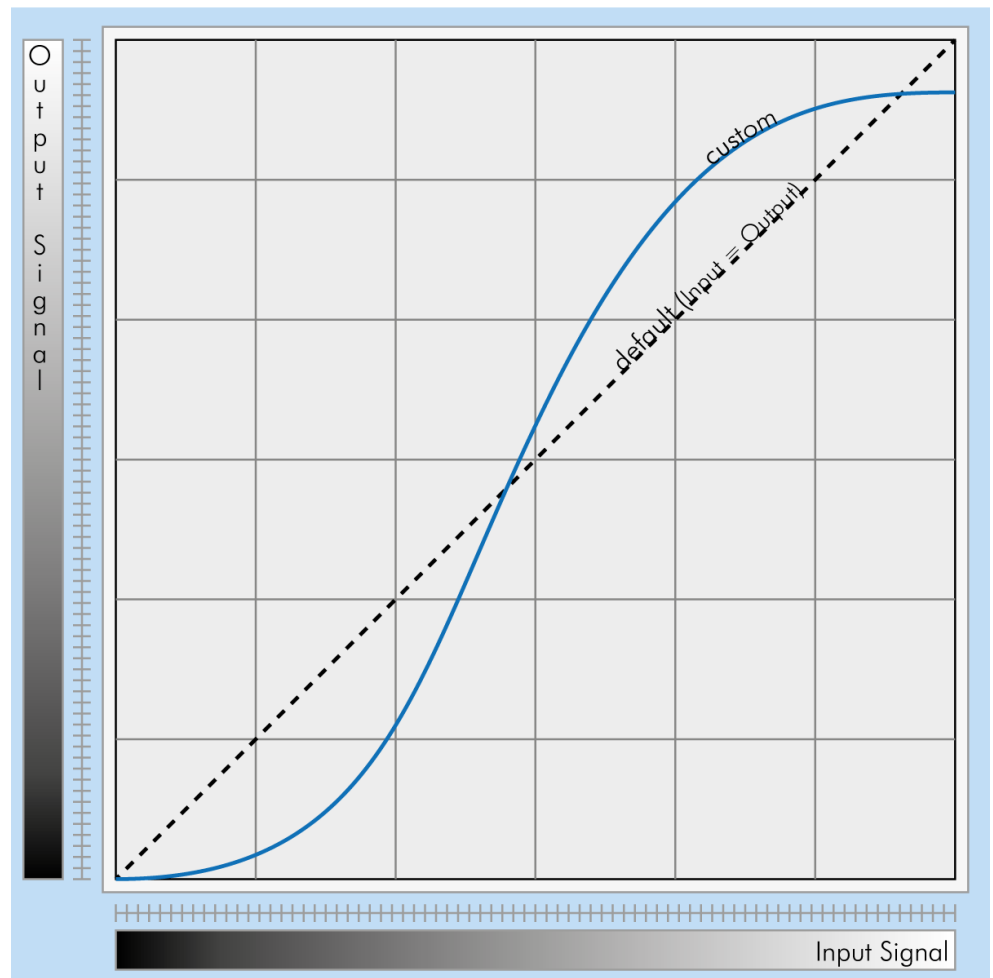

Fig. 5-23: Custom LUT adding contrast to the mid-tones

LUT implementation reduces bit depth from 12 bit to 8 bit on the output.

GAMMA CORRECTION

Using the look-up table makes it also possible to implement a logarithmic correction. This is commonly called “gamma correction”.

Historically gamma correction was used to correct the illumination behavior of CRT displays, by compensating brightness-to-voltage with a gamma value between 1,8 up to 2,55.

The gamma algorithms for correction can simplify resolution shifting as shown seen below.

- Input & output signal range from 0 to 1
- Output-signal = Input-signal^{Gamma}

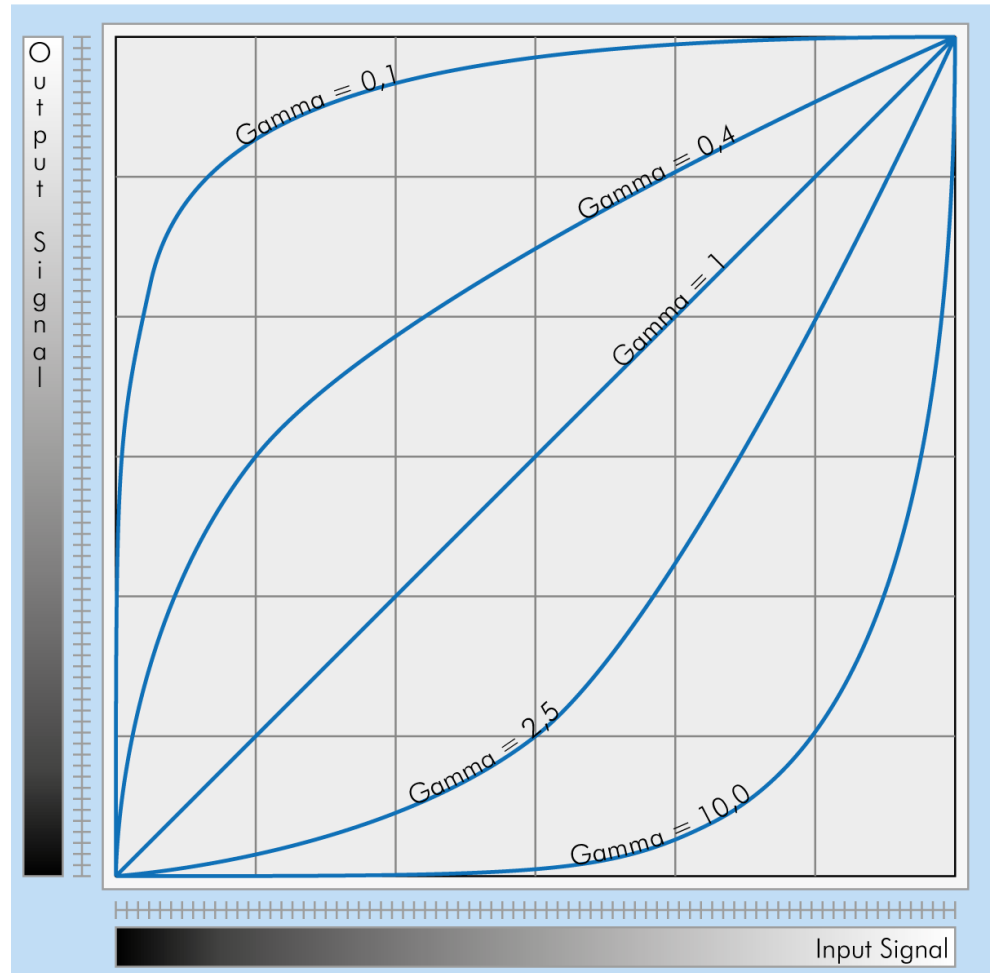

Fig. 5-24: Several gamma curves comparable to a LUT

- Gamma values less than 1.0 map darker image values into a wider ranger.
- Gamma values greater than 1.0 do the same for brighter values.

Gamma algorithm is just a way to generate a LUT. It is not implemented in the camera directly.

GAMMA CORRECTION

Using the look-up table makes is also possible to implement a logarithmic correction. This is commonly called “gamma correction”.

Historically gamma correction was used to correct the illumination behavior of CRT displays, by compensating brightness-to-voltage with a gamma value between 1,8 up to 2,55.

The gamma algorithms for correction can simplify resolution shifting as shown seen below.

- Input & output signal range from 0 to 1
- Output-signal = Input-signal^{Gamma}

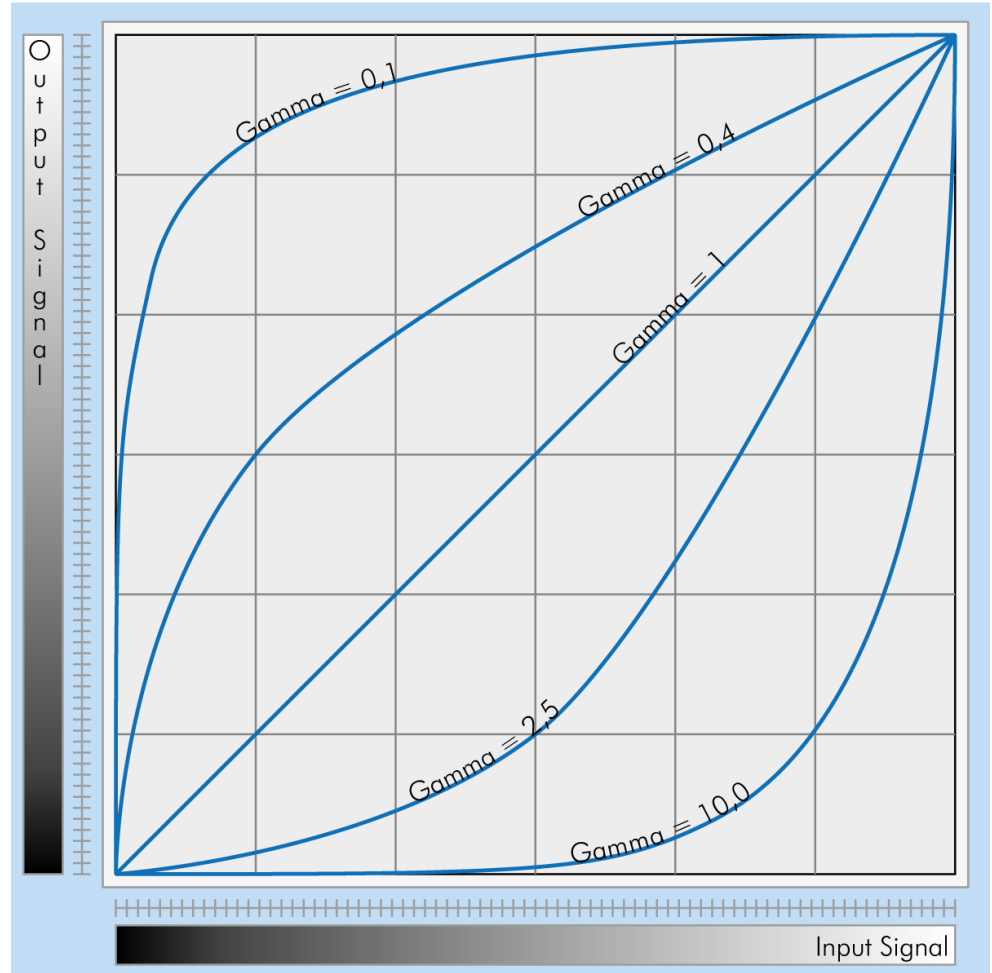

Fig. 5-25: Several gamma curves comparable to a LUT

- Gamma values less than 1.0 map darker image values into a wider ranger.
- Gamma values greater than 1.0 do the same for brighter values.

Gamma algorithm is just a way to generate a LUT. It is not implemented in the camera directly.

5.2.5

ROI / AOI

In partial scan mode or Area-Of-Interest (AOI) mode (or Region-Of-Interest (ROI) mode) only a certain region of the sensor will be read.

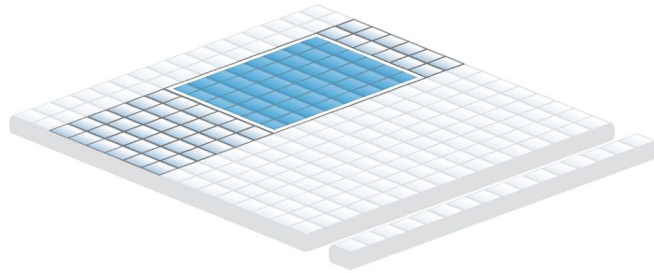

Fig. 5-26: AOI on area sensor

Selecting an AOI will reduce the number of horizontal lines being read. This will reduce the amount of data to be transferred, thus increasing the maximum speed in terms of frames per second.

With CMOS Sensors, AOI is sensor dependent. Some CMOS sensors require the camera to read full horizontal sensor lines internally. Reducing horizontal size with AOI might result in limited frame rate gain.

5.2.6

Basic capture modes

The camera has 2 basic operation modes.

- Free run (timed) run: The camera will expose and deliver images on a fixed schedule.
- Triggered: The camera will wait for an external signal and start exposure after receiving the external trigger signal.

FREE RUNNING

Free running (fixed frequency) with programmable exposure time. Frames are read continuously and valid data is indicated by LVAL for each line and FVAL for the entire frame.

There is no need to trigger the camera in order to get data. The exposure time is set via the serial interface and calculated by the internal logic of the camera.

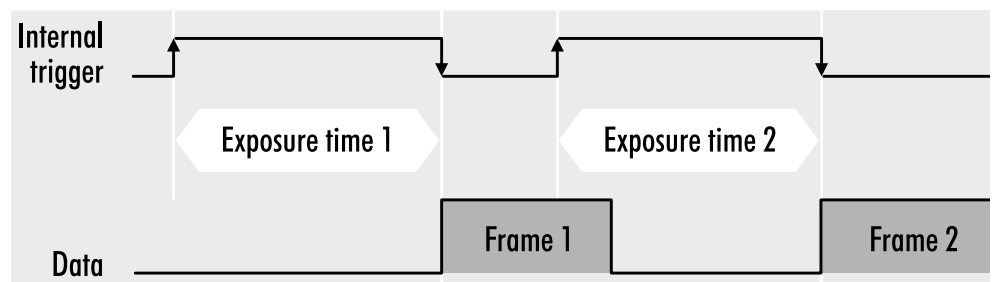

Fig. 5-27: Mode 0 - Free running with programmable exposure time

The fundamental signals are:

- Line Valid: LVAL
- Frame Valid: FVAL
- For triggered modes: trigger input

TRIGGERED MODE (PULSE WIDTH)

External trigger and pulse-width controlled exposure time. In this mode the camera is waiting for an external trigger, which starts integration and readout. Exposure time can be varied using the length of the trigger pulse (rising edge starts integration time, falling edge terminates the integration time and starts frame read out). This mode is useful in applications where the light level of the scene changes during operation. Change of exposure time is possible from one frame to the next.

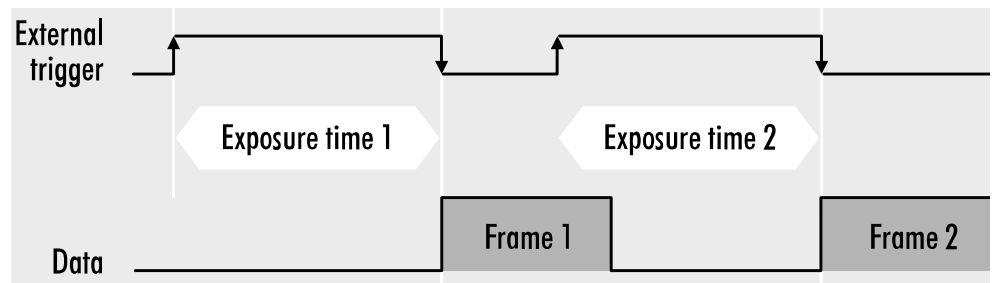

Fig. 5-28: Mode 1: External Trigger with Pulse Width Exposure Control (overlap)

Exposure time of the next image can overlap with the frame readout of the current image (rising edge of trigger pulse occurs when FVAL is high). When this happens: the start of exposure time is synchronized to the falling edge of the LVAL signal.

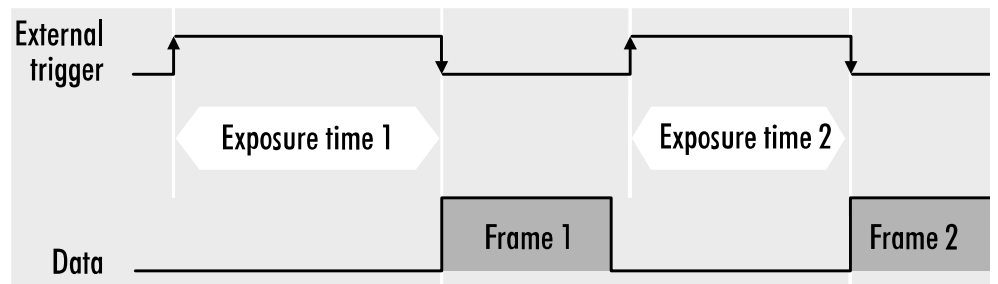

Fig. 5-29: Basic capture modes - triggered mode (pulse width without overlap)

When the rising edge of trigger signal occurs after frame readout has ended (FVAL is low) the start of exposure time is not synchronized to LVAL and exposure time starts after a short and persistent delay.

The falling edge of the trigger signal must always occur after readout of the previous frame has ended (FVAL is low).

SOFTWARE TRIGGER

Trigger can also be initiated by software or serial interface.

Software trigger can be influenced by jitter. Avoid software trigger when using time sensitive applications.

5.2.7 Read-out control

Read-out control defines a delay between exposure and data transfer. Read-out control is used to program a delay value (time) for the readout from the sensor.

With more than one camera connected to a single computer, image acquisition and rendering can cause conflicts for data transfer, on CPU or bus system.

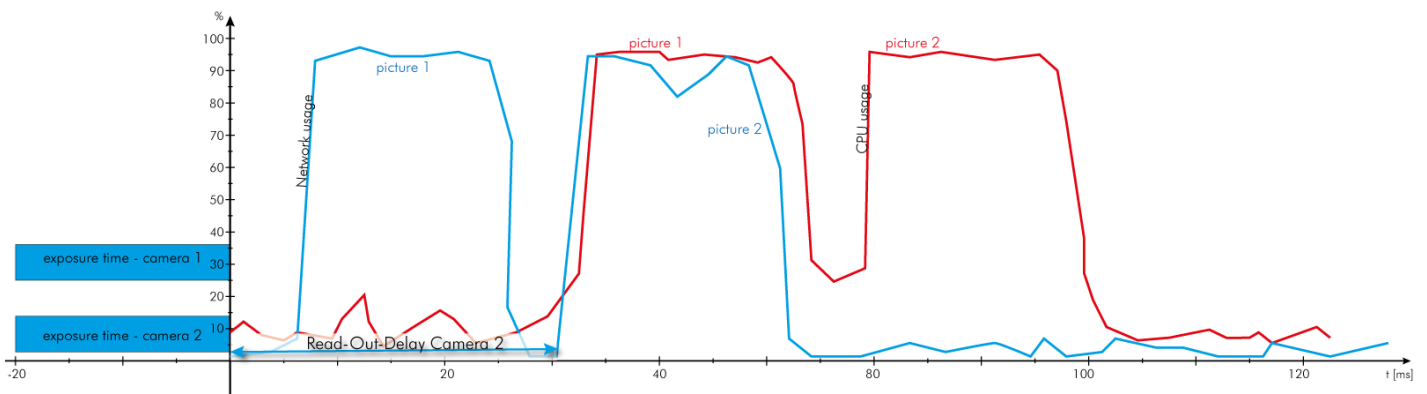

Fig. 5-30: Illustration of physical data stream in time

5.2.8 System clock frequency

Default system clock frequency in almost every SVCam is set to 66.6 MHz. To validate your system frequency refer to: specifications.

Using the system clock as reference of time, time settings can only be made in steps. In this example, the transfer rate is 66.7 MHz, thus resulting in steps of 15 ns.

$$t = \frac{1}{66.6 \text{ MHz}} = \frac{1}{66\,666\,666.6 \frac{1}{s}} = 15 \cdot 10^{-9} \text{ s} = 15 \text{ ns}$$

Use multiples of 15 ns to write durations into camera memory.

5.2.9 Predefined configurations (user sets)

The camera starts with default values for all features when turned on. Settings made during operation will expire when the camera is turned off.

All preset adjustments are located in the GenICam tree in the "User Set Control" property. It is possible to save up to 8 user sets. Each of these setups consists of a complete configuration set including exposure time, delays, I/O configuration for the camera. These user sets can be loaded at run-time. In addition, you can specify which setup is loaded as default when the camera is switched on.

LOAD A USER SET

With UserSetSelector a user set can be selected. Select the desired user set and press UserSetLoad (command) twice to load the user set. The following example loads user set 2.

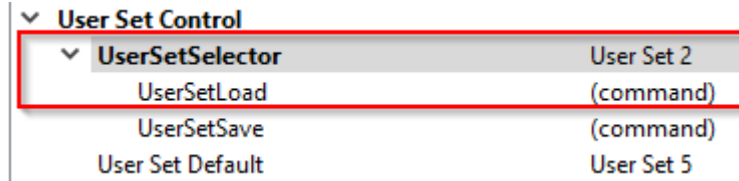

A screenshot of a menu titled "User Set Control". Underneath, there is a sub-menu "UserSetSelector" which is expanded. The sub-menu contains four items: "UserSetLoad (command)", "UserSetSave (command)", and "User Set Default". To the right of these items are "User Set 2", "User Set 5", and "User Set 5" respectively. A red box highlights the "UserSetSelector" sub-menu and the "User Set 2" option.

▼ User Set Control	
▼ UserSetSelector	User Set 2
UserSetLoad	(command)
UserSetSave	(command)
User Set Default	User Set 5

SAVE USER SETS

Select the user set to be saved in the UserSetSelector and save it with the UserSetSave command.



A screenshot of a menu titled "User Set Control". Underneath, there is a sub-menu "UserSetSelector" which is expanded. The sub-menu contains four items: "UserSetLoad (command)", "UserSetSave (command)", and "User Set Default". To the right of these items are "User Set 2", "User Set 5", and "User Set 5" respectively. A red box highlights the "UserSetSelector" sub-menu and the "UserSetSave (command)" option.

▼ User Set Control	
▼ UserSetSelector	User Set 2
UserSetLoad	(command)
UserSetSave	(command)
User Set Default	User Set 5

SET A USER SET AS DEFAULT

Use User Set Default to select the user set that is to be loaded when the camera is started. Save this setting with UserSetSave (In the example below, user set 5 is saved as default).



A screenshot of a menu titled "User Set Control". Underneath, there is a sub-menu "UserSetSelector" which is expanded. The sub-menu contains four items: "UserSetLoad (command)", "UserSetSave (command)", and "User Set Default". To the right of these items are "User Set 2", "User Set 5", and "User Set 5" respectively. A red box highlights the "UserSetSelector" sub-menu and the "UserSetSave (command)" option. A red circle with the number "2" is next to "UserSetSave (command)", and a red circle with the number "1" is next to "User Set Default".

▼ UserSetSelector	User Set 2
UserSetLoad	(command)
UserSetSave	(command)
User Set Default	User Set 5

RESET TO FACTORY DEFAULT

User sets can be reset to factory settings. This is a two-step process. First, the factory settings must be loaded:



A screenshot of a menu titled "User Set Control". Underneath, there is a sub-menu "UserSetSelector" which is expanded. The sub-menu contains four items: "UserSetLoad (command)", "UserSetSave (command)", and "User Set Default". To the right of these items are "Default User Set", "Default User Set", and "Default User Set" respectively. A red box highlights the "UserSetSelector" sub-menu and the "UserSetLoad (command)" option. A red circle with the number "1" is next to "UserSetSelector", and a red circle with the number "2" is next to "UserSetLoad (command)".

▼ User Set Control	
▼ UserSetSelector	Default User Set
UserSetLoad	(command)
UserSetSave	(command)
User Set Default	Default User Set

Afterwards this factory default user set must be saved again as user set (in the example below, user set 2 is overwritten with the factory settings).

▼ User Set Control	
▼ UserSetSelector	User Set 2
UserSetLoad	(command)
UserSetSave	(command)
User Set Default	User Set 5

5.2.10

Colour transformation control

The colour transformation control feature is available only for colour cameras. Use your model specification whether your model is covered with the latest firmware.

See also chapter ["Color" on page 34](#) for basic colour functionalities and chapters ["Gain" on page 32](#) and ["Offset" on page 33](#) for understanding gain and offset. In most cases colour transformation will replace white balance, see ["White balance"](#).

In the world of industrial image processing, image sensors are built to reproduce brightness values as precisely as possible, with sensitivity, size and dynamic range being decisive criteria. A colour representation according to the colour perception of the human eye is not a design requirement of these image sensors. The colour transformation feature generates an image representation similar to the human colour perception by transforming the colours. The decisive factors here are the selected light temperature of the illumination and the design of the sensor pixel. The colour transformation feature provides ready-to-use conversion matrices for the standardized light temperatures D50, D65, TL84, and A. Furthermore, it is possible to define the conversion matrix yourself and thus adapt the colour rendering to your own lighting situation.

RESULT OF THE COLOUR CONVERSION

The following images (with identical illumination, cloudy daylight) illustrate the effect of the conversion. As an industrial-vision sensor, the sensor has a clear emphasis of the green channel. The granite stone in the foreground is grey.



Fig. 5-31: Colour transformation OFF, D50, D65, TL84, A

The mathematical conversion of the colour values leads to an colour-reproduction reflecting the human eye perception, but reduces the number of displayable colours due to the limited bit depth. As an example the histograms of the above images without colour correction and with D50

correction enabled. Despite the larger value variations in the channels, the human eye perceives the D50 correction as more colour-correct. The conversion due to the different gain values can result in increased noise and colour noise.

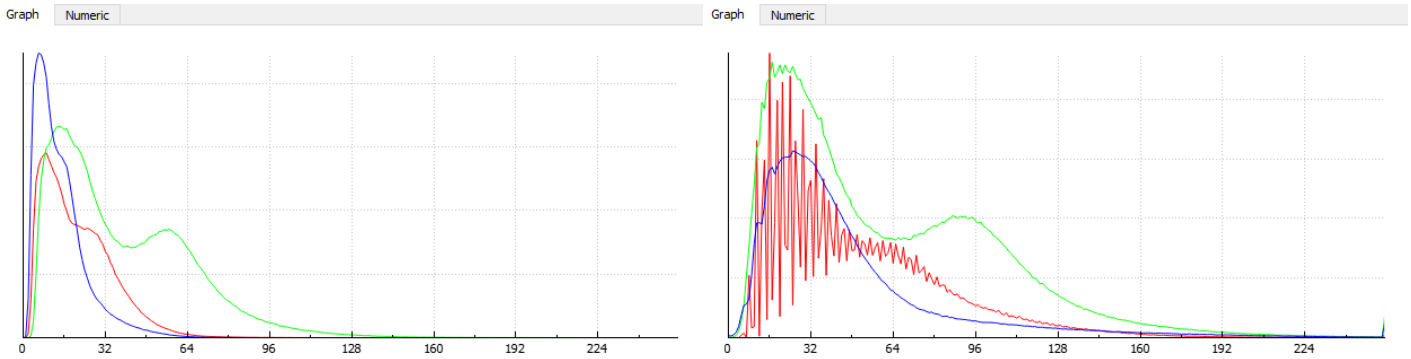

Fig. 5-32: Histograms of the same image as above without and with colour transformation D50

THE COLOUR MATRIX

The conversion of each pixel is done using a matrix of gain values and a 1x3 offset matrix \mathbf{O} . The offset matrix is an integer matrix.

$$(\mathbf{O}) = \begin{pmatrix} Off_R \\ Off_G \\ Off_B \end{pmatrix}$$

All gain values are float type values. The nomenclature is "Gain L(ine)C(olumn)" like "Gain 00". Generally, the conversion is done for each pixel by a matrix operation with \mathbf{M} being the 3x3 gain matrix:

$$\begin{pmatrix} R_{new} \\ G_{new} \\ B_{new} \end{pmatrix} = (\mathbf{M}) * \begin{pmatrix} R \\ G \\ B \end{pmatrix}$$

Below some examples of colour correction matrices:

Gain	0	1	2
0	2.82	-1.08	0.34
1	-0.23	2.61	-1.13
2	0.21	-1.27	5.7
Offset	1.07	2.88	0.44

Table: 5-2: Colour matrix fxo540, light D50

Light temperature D65 is more blue, values deviate significantly to get a correct colour representation:

Gain	0	1	2
0	3.52	-1.08	0.15
1	-0.34	2.53	-0.83
2	0.17	-1.18	4.35
Offset	2.32	2.91	1.24

Table: 5-3: color matrix fxo540, light D65

USING THE COLOUR TRANSFORMATION CONTROL FEATURE

As the colour transformation is done in the camera FPGA, the adjustment is done in the GenICam tree:

1. Enable colour transformation.

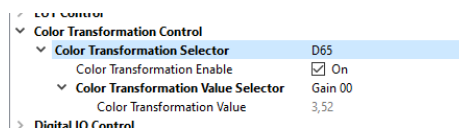

2. Specify the desired light temperature with the colour transformation selector (the values for D50, D65, LT84, A are optimized for the sensor of the respective camera and cannot be changed)

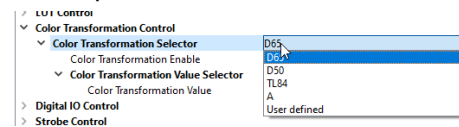

CUSTOM COLOUR TRANSFORMATION

If a conversion with the pre-set light temperatures is not sufficient for the specific application (no standardized light source), it is possible to define your own conversion matrices.

1. Set the colour transformation selector to "user defined".
2. Select Colour Transformation Value and enter the corresponding colour transformation value. This must be done for all 9 gain values as well as for the 3 offset values. Results will be visible immediately in the image.

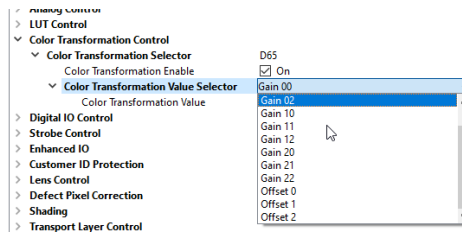

3. Select the custom colour transformation values.

5.2.11

Fan control

The camera has a built-in fan that is set to automatic mode by default. The fan directs the airflow externally past the camera to avoid contamination inside the camera. The fan offers the following advantages:

- Small camera footprint (due to lack of large heat sinks) ensures easy integration
- Large temperature range in standalone operation
- Heat dissipation mainly through the thermo-mechanical connection of the housing
- Fan can be switched off if necessary. Ensure a good thermal connection to the camera housing.
- The fan activity mode can be set in the GenICam tree.

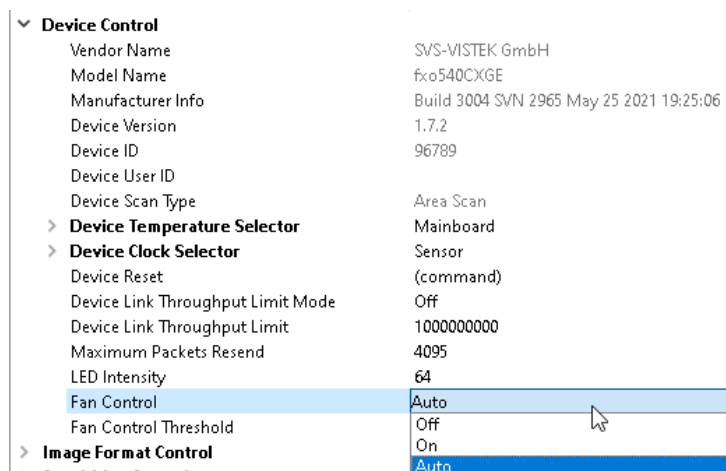

The threshold value in section **Fan Control** defines the sensor temperature at which the fan becomes active in Auto mode (default: 60 °C).

5.2.12

Precision Time Protocol

PTP (Precision Time Protocol) is a protocol according to IEEE1588 to synchronise several devices in a common Ethernet network. PTP IEEE1588 is part of the GigE Vision Standard 2.0.

Cameras from Allied Vision require firmware b2987 at least for operating PTP.

According to the PTP protocol, several devices agree on a master. The other devices in the network communicate with the master as slaves and synchronize their own time base for the time stamp with the time base of the master. The maximum deviation permits deviations of typically 10 μ s. The common time base is not to be confused with real time in normal camera systems. To obtain a fixed relation to the real world time, an NTP or GPS device has to be defined as PTP master.

Cameras participating in PTP are set to a special PTP mode. As soon as the PTP mode is set to Master, Slave or Auto, the synchronisation of the cameras in the network begins, provided that a device has previously been configured as master. The first camera in the network sending the "Ptp Data Set Latch" command will be declared master, all others will be slave.

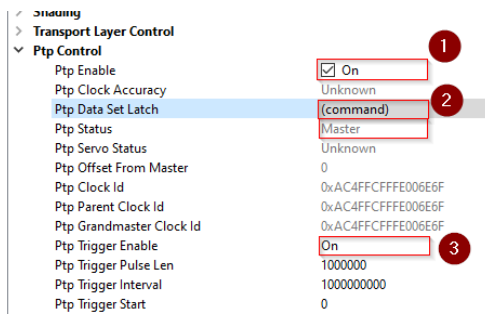

Fig. 5-33: PTP set master mode

SYNCHRONIZE CAMERA TRIGGER

If a camera is to be triggered via PTP, it must be operated in PTP slave mode. For this, the camera has to be configured in PTP slave mode and the I/O trigger line selector must be set to PtpTrigger. The Ptp set latch command will lock the common timebase.

Only the trigger event will be synchronized. The cameras can still be run with different exposure times.

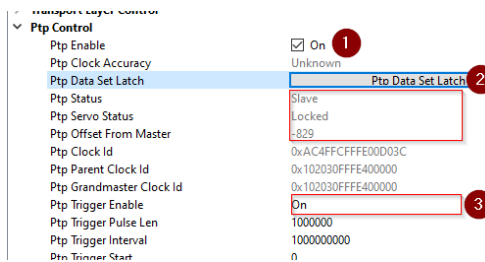

Fig. 5-34: PTP set slave mode

Enable the synced trigger in with 2 steps.

1. Enable Trigger Mode and set Trigger Mode to Line1.
2. Connect the Trigger with PtPTrigger source in the I/O matrix. The slave camera will follow the master's trigger events.

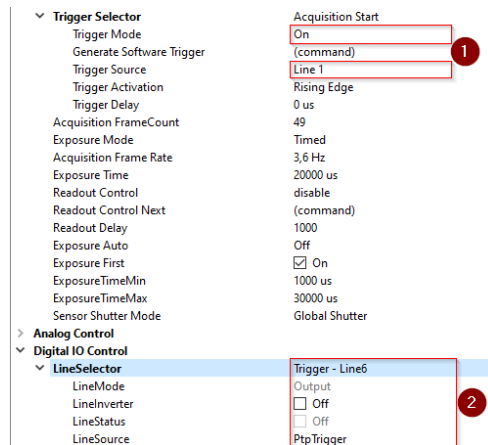

Fig. 5-35: Enable synced multi camera trigger in PTP slave mode

Slave operation with Precision Time Protocol is permitted with timed exposure only.

It is recommended to connect the cameras with a single switch. Daisy-chain switches are not permitted.

5.3 I/O Features

The SVCam cameras are equipped with several inputs and outputs, providing state-of-the-art control regarding input and output channels. All I/O functions are realized as modules. These functions can be connected in the GenICam tree.

5.3.1 Pulse width modulation

During pulse width modulation (PWM), a duty cycle is modulated by a fixed frequency square wave. This describes the ratio of ON to OFF as duty factor or duty ratio.

WHY PWM?

Pulse width modulation is an extremely efficient way (in terms of power dissipation) to provide or regulate electrical power to consumers as long as they do not need uninterrupted supply (such as diodes or LEDs). The interruption times might be as short as nano seconds.

LED CHARACTERISTICS

Since LEDs have a bounded workspace, the PWM ensures a variable intensity of illumination at a constant current on the diodes. The constant current guarantees a linear light emission response curve of the LED from 0-100% PWM intensity.

Running LED lighting in flash mode will increase LED lifetime because of reduced LED heat dissipation.

IMPLEMENTATION OF PWM

The basic frequency of the modulation is defined by the cycle duration "T".

$$T_{PWM} = \frac{1}{f_{PWM}}$$

Duty cycle "T" is written into the registry by multiple of the inverse of camera frequency in 15 ns steps.

$$T_{PWM} = \frac{1}{66,6 MHz} \bullet PWMMax [SeqSelector] = 15 ns \bullet PWMMax [SeqSelector]$$

THE INTENSITY OF A PWM

The duty ratio is calculated as: $\Delta\% = t / T$. It is written above the value of "t" as PWMChange0-3[SeqSelector] per sequence into the registry.

PWMChange0-3[SeqSelector] unit is percentage value.

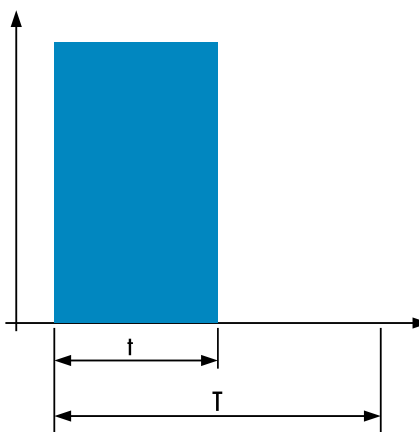

Fig. 5-36: PWM intensity

EXAMPLES OF PWMS

The integrals over both periods T_A and T_A are equal.

$$\int_{t_{A1}}^{t_{A2}} \mathbf{A} = \int_{t_{B1}}^{t_{B2}} \mathbf{B}$$

An equal amount of Photons will be emitted. The intensity of light is the same.

$$t_{A2} - t_{A1} = t_{B2} - t_{B1}$$

The periods T_A and T_B are equal in length.

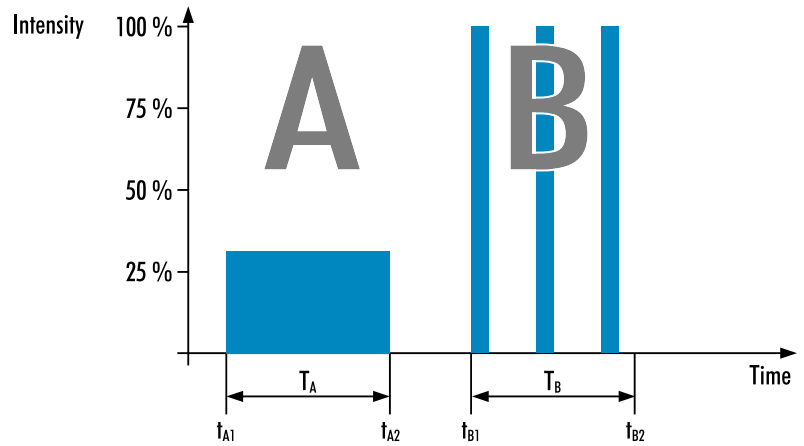

Fig. 5-37: Example: 25% PWM load

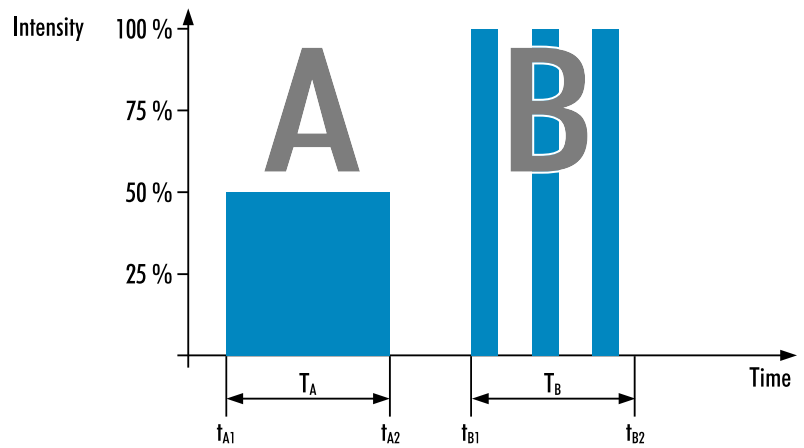

Fig. 5-38: Example: 50% PWM load

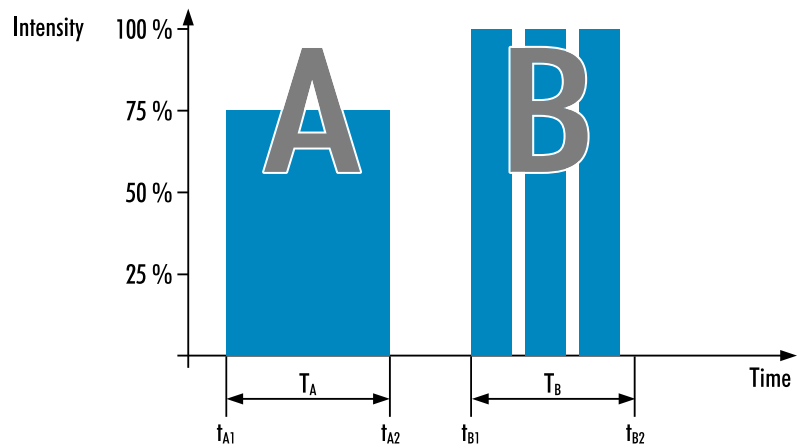

Fig. 5-39: Example: 75% PWM load

THE PWM MODULE

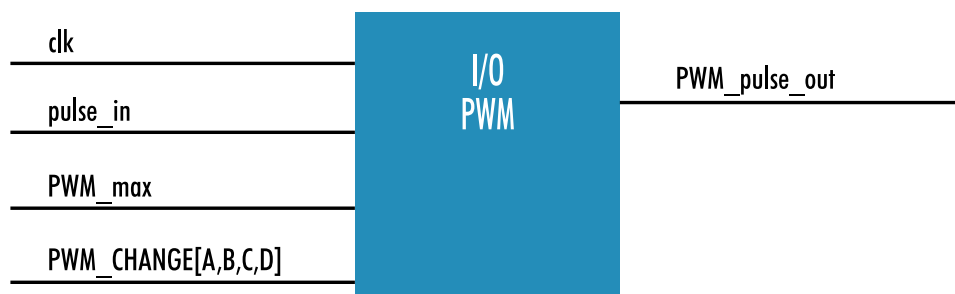

Fig. 5-40: The PWM module

5.3.2

LED strobe control

The SVCam 4I/O concept contains an integrated strobe controller. Its controls are integrated into the GenICam tree. With LED lights attached to the outputs, this enables the user to control the light without external devices. Being controlled via GenICam, any GenICam-compliant 3rd party software is able to control the light as well. Maximum ON-time is 100 ms. Depending on the camera model, up to four (see specifications) independent channels are supported with a max current of 3A@40 ms per 1 s (or 4 %). Maximum continuous current is 0.3 A. Despite internal protections, higher current peaks might be able to damage the camera.

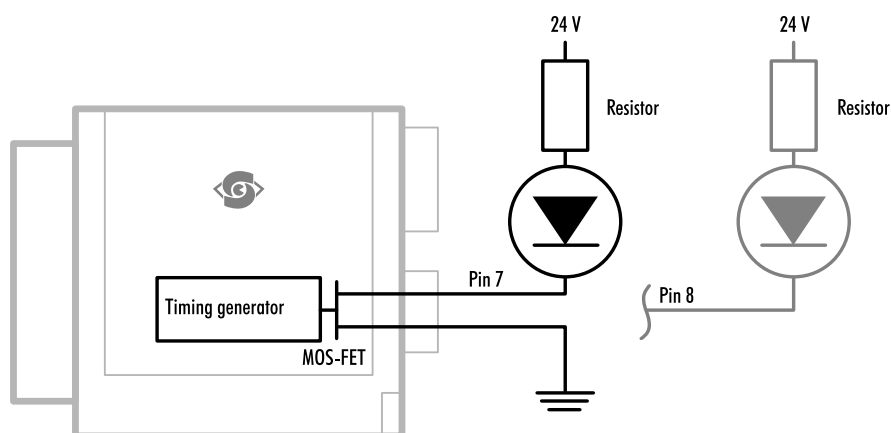

Fig. 5-41: Attach LED lights to camera outputs

To avoid destruction of your LED light or camera, make sure to use the right dimension of shunt resistor.

STROBE POLARITY

Positive or negative polarity of the hardware strobe output can be selected.

STROBE DURATION

The exposure time of LED lights can be set in tics. The min duration is 1 μ s. The longest time is 1 second.

STROBE DELAY

The delay between the (logical) positive edge of trigger pulse and strobe pulse output.

EXPOSURE DELAY

A tic value, representing the time between the (logical) positive edge of trigger pulse and start of integration time.

CALCULATE LED SHUNT RESISTORS

Shunt resistors are used to limit the LED current. Make sure, neither shunt nor LED run above specs.

LEDS IN CONTINUOUS MODE

Specification	Value
Voltage drop al 5 LEDs, 2,2V per LED (see spec. of LED)	11 V
Max. continuous current (see spec. of LED)	250 mA
Voltage supply	24 V
Voltage drop at resistor (24 V - 11 V)	13 V
Pull up Resistor $R = \frac{13 V}{250 mA}$	52 Ω

Table: 5-4: LEDs in continuous mode

Specification	Value
Total power ($P = U \times I$)	6 W
Power at LEDs ($11 V \times 250 mA$)	2,75 W
Power loss at resistor ($13 V \times 250 mA$)	3,25 W

Table: 5-5: Example Calculation "No Flash" (CW Mode)

LEDS IN FLASH MODE

Most LED lights can cope with currents higher than specs. This gives you higher light output when light is ON. Refer to your LED specs if LED overdrive is permitted.

By controlling the duty cycle the intensity of light and current can be controlled. See sequencer example how to adjust the values in the GenICam tree for strobe control.

The shorter the „time on“ – the higher current can be used when driving LEDs with current higher than spec

Make sure your PWM lighting frequency is at least double or triple the bit-depth of your image (e.g. 8 bit image = 256, this means your PWM has to be switched at least $256*2=512$ times) while exposing. If exposure time is 5 ms, the required minimum PWM freq = $5 \text{ ms} / 512 \sim 10 \mu\text{s} \sim 100 \text{ kHz}$.

STROBE VOCABULARY

For an example how to enable and adjust the integrated strobe controller refer to sequencer (see "[Sequencer](#)" on page 78). Times and frequencies are set in tics. 1 tic = 15 ns.

EXPOSURE DELAY

A tic value, representing the time between the (logical) positive edge of trigger pulse and start of integration time.

STROBE POLARITY

Positive or negative polarity of the hardware strobe output can be selected.

STROBE DURATION

The exposure time of LED lights can be set in tics. The min duration is 1 μs . The longest time is 1 second.

STROBE DELAY

The delay between the (logical) positive edge of trigger pulse and strobe pulse output.

5.3.3

Sequencer

The sequencer is used when different exposure settings and illuminations are needed in a row.

Values to set	Description
Sequencer interval	Duration of the interval
Exposure start	Exposure delay after interval start
Exposure stop	Exposure stop related to interval Start
Strobe start	Strobe delay after interval start
Strobe stop	Strobe stop related to interval Start
PWM frequency	Basic duty cycle (1 / Hz) for PWM
PWM change	Demodulation results

In the current GenICam implementation, all values have to be entered in tic values.

$$1 \text{ tic} = 15 \text{ ns}$$

Every adjustment (times, frequencies) has to be recalculated into tics and done in tics. See the example below.

When setting "Exposure Start" and "Stop" consider 'read-out-time' of the sensor. It has to be within the Sequencer interval.

For physical input and output connections refer to pin-out or specifications or see example below. After trigger signal all programmed intervals will start. Up to 16 intervals can be programmed.

Sequencer settings can be saved to camera EEPROM.

EXAMPLE

SCENARIO

An object should be inspected with a monochrome camera. For accentuating different aspects of the image, 4 images should be taken in a row with 4 different colors of light: red, green, blue, white. White light should be generated from the RGB lights being activated at the same time. Basis is a dark environment without other light sources.

CAMERA WIRING

- 3 LED lights are physically connected to the camera on out 0-2 (red, green, blue)

- Out 3 is not used

I/O MATRIX

- 4 images to be taken (RGBW) result in 4 sequences
- RGB PWM change with different intensities (duty cycle) taking care for differences in spectral response of the camera sensor
- PWM change 0-2 is connected to out 0-2
- Seq pulse A is driving the exposure (trigger)
- Seq pulse B is driving the strobe
- Seq pulse B in WHITE sequence is reduced down to 33% as light intensities of 3 lights (RGB) will add up

NOTES

- Different exposure / strobe timings are used for illustration. In most cases they will show values same as exposure
- The resulting exposure time shows the period of sensor light exposure. ("masking" of exposure time by creating strobe light impulses shorter than exposure time). This value is not adjustable at the camera
- PWM change is shown with reduced height for demonstrating reduced intensity. In reality though, PWM change will be full height (full voltage, shunt resistor might be necessary) with the adjusted duty cycle
- Use a PWM frequency high enough not to interfere with your timings (here: 1000 Hz)

Scenario values	Interval 0 (RED)	Interval 1 (GREEN)	Interval 2 (BLUE)	Interval 3 (WHITE)
Sequencer Interval	1000 ms	1000 ms	1000 ms	1000 ms
Seq pulse A start	0 ms	0 ms	100 ms	0 ms
Seq pulse A stop	100 ms	300 ms	300 ms	100 ms
Seq pulse B start	0 ms	100 ms	200 ms	0 ms
Seq pulse B stop	100 ms	200 ms	300 ms	33 ms
PWM Frequency f	1000 Hz	1000 Hz	1000 Hz	1000 Hz
PWM change 0 (RED)	100%	0%	0%	100%
PWM change 1 (GREEN)	0%	70%	0%	70%
PWM change 2 (BLUE)	0%	0%	80%	80%
PWM change 3	-	-	-	-

As stated before, all these values have to be entered into the camera's GenICam tree as tic values.

The timing values translate like this into tics:

Values to set in GenICam properties	Interval 0 (RED)	Interval 1 (GREEN)	Interval 2 (BLUE)	Interval 3 (WHITE)
Sequencer Interval	6666667 tic (1000 ms)	6666667 tic (1000 ms)	6666667 tic (1000 ms)	6666667 tic (1000 ms)
Seq pulse A start	0 tic (0 ms)	0 tic (0 ms)	666667 tic (100 ms)	0 tic (0 ms)
Seq pulse A stop	666667 tic (100 ms)	2000000 tic (300 ms)	2000000 tic (300 ms)	666667 tic (100 ms)
Seq pulse B start	0 tic (0 ms)	666667 tic (100 ms)	13333333 tic (200 ms)	0 tic (0 ms)
Seq pulse B stop	666667 tic (100 ms)	13333333 tic (200 ms)	2000000 tic (300 ms)	2200000 tic (33 ms)
Effective exposure time	100 ms	100 ms	100 ms	33 ms
PWM Frequency f	66667 tic (1000 Hz)	66667 tic (1000 Hz)	66667 tic (1000 Hz)	66667 tic (1000 Hz)
PWM change 0 (RED)	66667 tic (100% of 1000 Hz)	0 tic	0 tic	66667 tic (100% of 1000 Hz)
PWM change 1 (GREEN)	0 tic	46667 tic (70% of 1000 Hz)	0 tic	46667 tic (70% of 1000 Hz)
PWM change 2 (BLUE)	0 tic	0 tic	53333 tic (80% of 1000 Hz)	53333 tic (80% of 1000 Hz)
PWM change 3	-	-	-	-

In a timings diagram, the sequence values above will look like the following diagram:

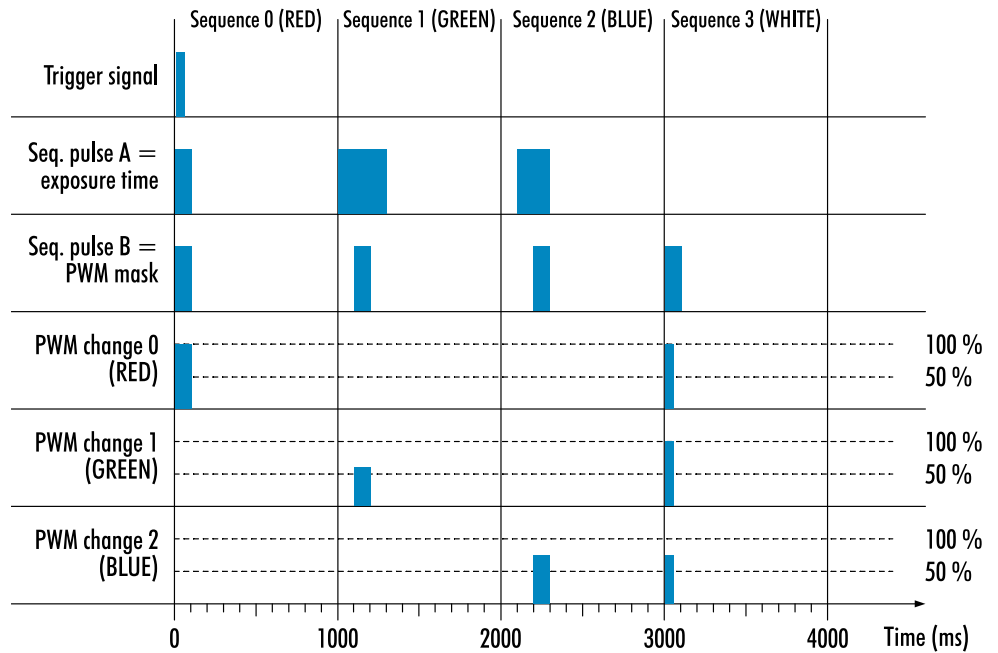

Fig. 5-42: Sequencer timing diagram

5.3.4

Optical input

In many trigger signals you find noise, transients and voltage spikes. These are able to damage components in the camera and trigger signal interpretation might be difficult.

An optical input separates the electrical trigger and camera circuits. The benefit of such an optical input is to avoid all these kinds of interaction from power sources or switches. The disadvantage of an optical input is that it is slower in terms of signal transmission and slew rate than a direct electrical connection.

If you need super fast response from the camera, direct electrical access is your choice. If your camera trigger is in the ms range or slower, we recommend to use the optical input.

An optical input needs some current for operation. The Allied Vision optical input is specified to 5-24 V, 8 mA.

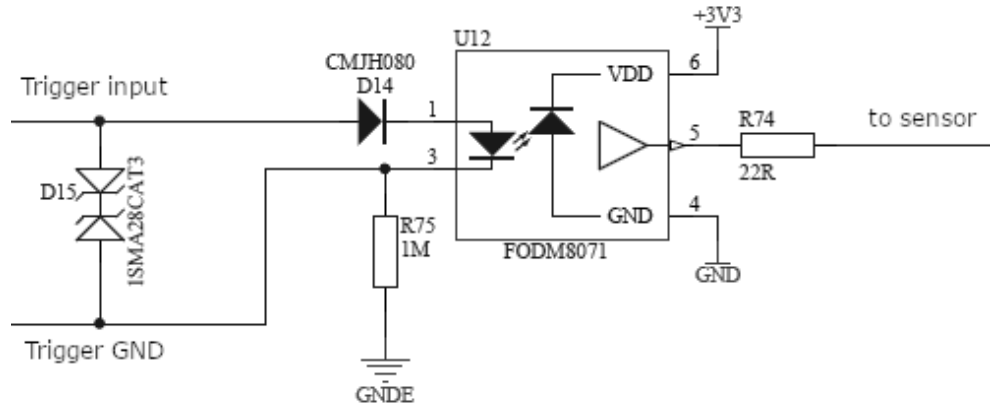

Fig. 5-43: Optical input

The optocoupler galvanically separates electrical circuits by emitting light on one side and interpreting light in the other. There is no direct electric interaction between both electrical circuits.

5.3.5

PLC / Logical operation on inputs

The logic input combines trigger signals with Boolean algorithms. The camera provides AND, NAND, OR, NOR, XOR, XNOR as below. You might combine combine true or false states of the inputs to determine camera actions. The result can be connected to a camera trigger signal or it may be source for the next logical operation with another input. It is possible to connect it to an OUT line as well.

GENICAM TREE SETTING

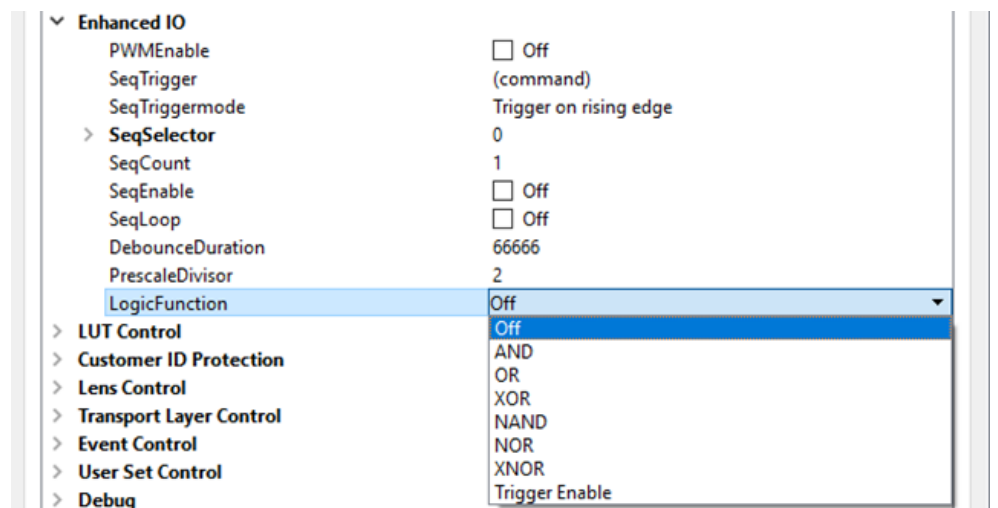

The logic function always combines the values of Digital IO InputA / LogicA and InputB / LogicB. In case of the trigger enabled logic function, LogicB is the trigger enable signal and will be combined with LogicA value.

AND	NAND	OR	NOR	XOR	XNOR
A B Y	A B Y	A B Y	A B Y	A B Y	A B Y
0 0 0	0 0 1	0 0 0	0 0 1	0 0 0	0 0 1
0 1 0	0 1 1	0 1 1	0 1 0	0 1 1	0 1 0
1 0 0	1 0 1	1 0 1	1 0 0	1 0 1	1 0 0
1 1 1	1 1 0	1 1 1	1 1 0	1 1 0	1 1 1

Table: 5-6: Truth table of logic function

Expert view of the GenICam tree has to be activated to see logic functions.

5.3.6

Serial data interfaces

(ANSI EIA/) TIA-232-F

RS-232 and RS-422 (from EIA, read as Radio Sector or commonly as Recommended Standard) are technical standards to specify electrical characteristics of digital signaling circuits. Serial connection might be used to control SVCams. These signals are used to send low-power data signals to control exposure, light or lenses (MFT). Usage scenario is a control possibility without network. Be aware of low connection speed.

Serial interface parameter	RS-232	RS-422
Maximum open-circuit voltage	±25 V	±6 V
Max differential voltage	25 V	10 V
Min. signal range	±3 V	2 V
Max. signal range	±15V	10 V

Table: 5-7: Serial interface parameters – RS-232 and RS-422

See your camera data sheet regarding its serial capabilities.

Data transport is always asynchronous. Synchronization is implemented by fist and last bit of a package. Data rate (bits per second) must be defined before transmission.

RS232

RS232 is split into 2 lines receiving and transferring data.

- RXD: receive data
- TXD: transmit data

Signal voltage values are:

- Low: -3 ... -15 V
- High: +3 ... +15 V

For restrictions, refer to table of serial interface parameter above.

Packaging data into containers (adding start and stop bits) is implemented by the UART (Universal Asynchronous Receiver Transmitter).

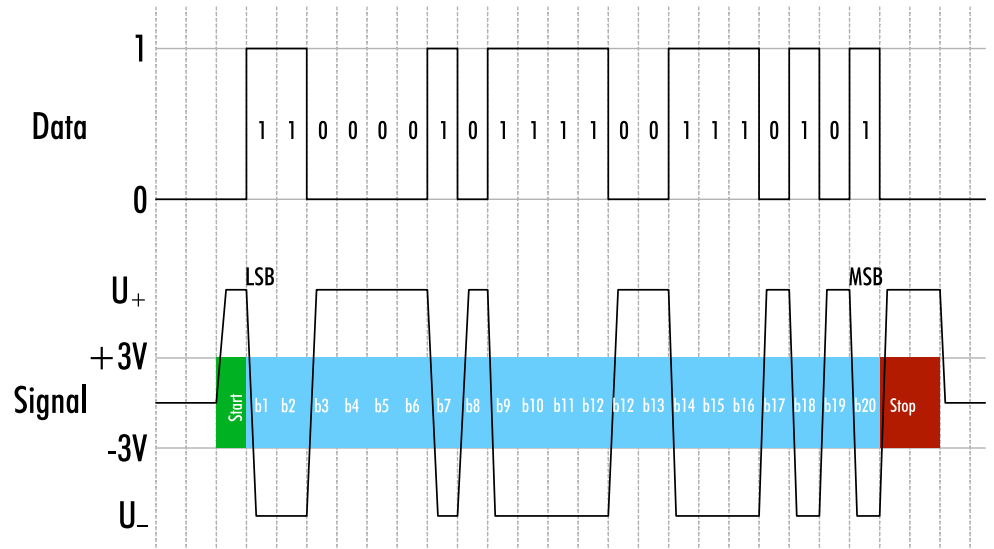

Fig. 5-44: UART encoding of a data stream

5.3.7

Trigger-edge sensitivity

Trigger-edge sensitivity is implemented by a “Schmitt trigger”. Instead of triggering to a certain value, the Schmitt trigger provides a threshold.

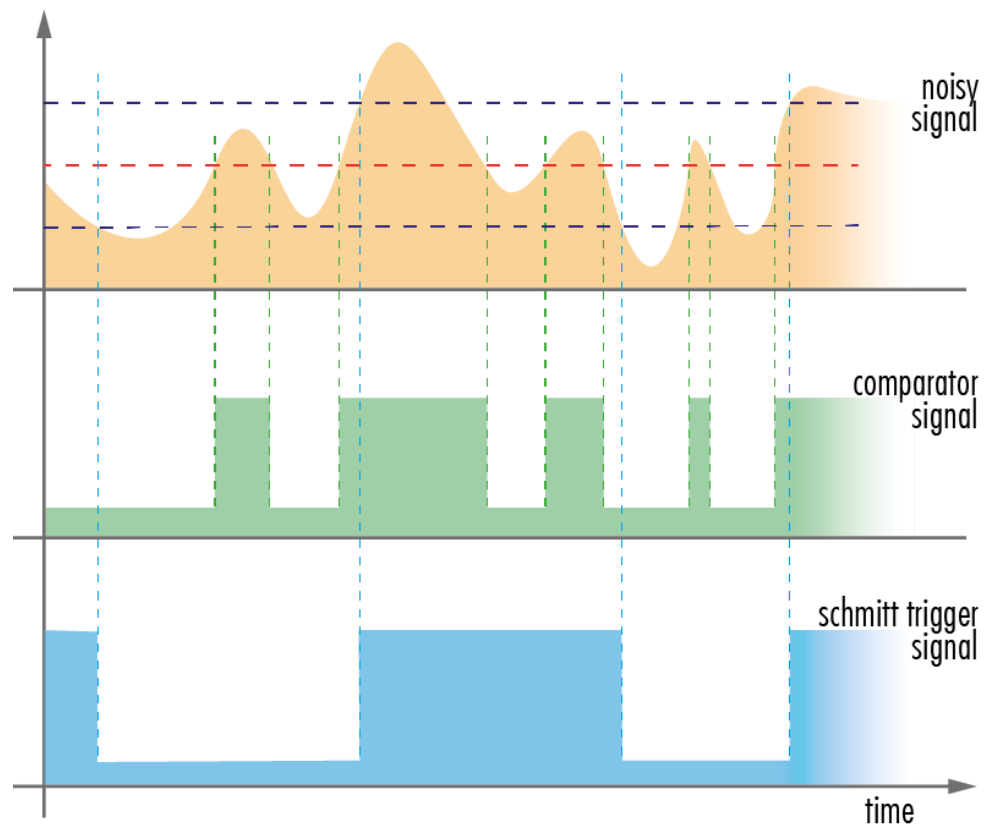

Fig. 5-45: Schmitt trigger noise suppression

5.3.8

Debouncing trigger signals

Bounces or glitches caused by a switch can be avoided by software within SVCam.

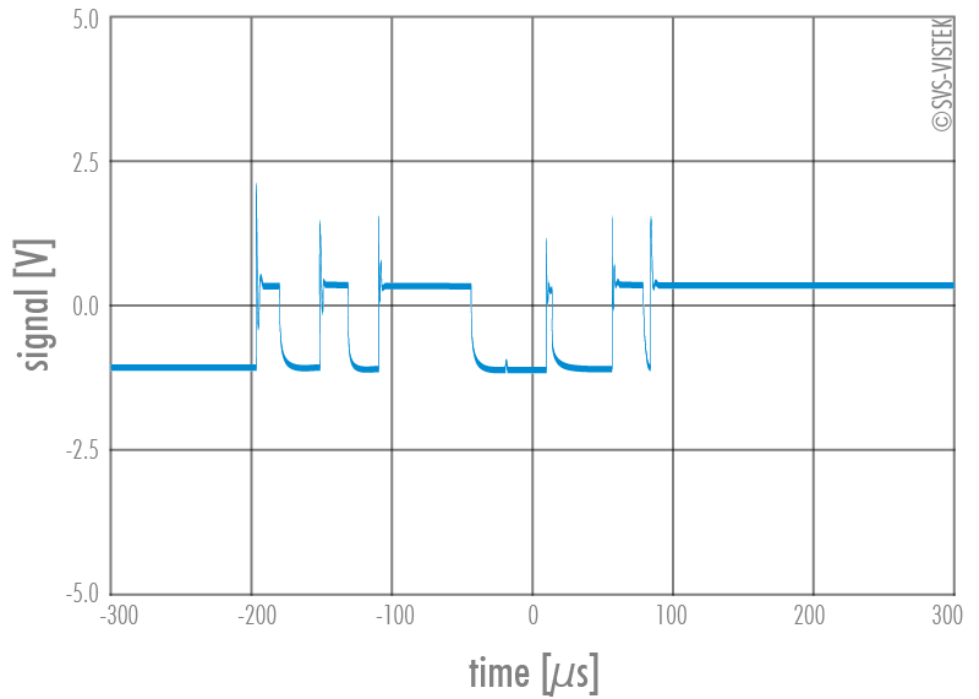

Fig. 5-46: Bounces or glitches caused by a switch

Therefore the signal will not be accepted until it lasts at least a certain time.

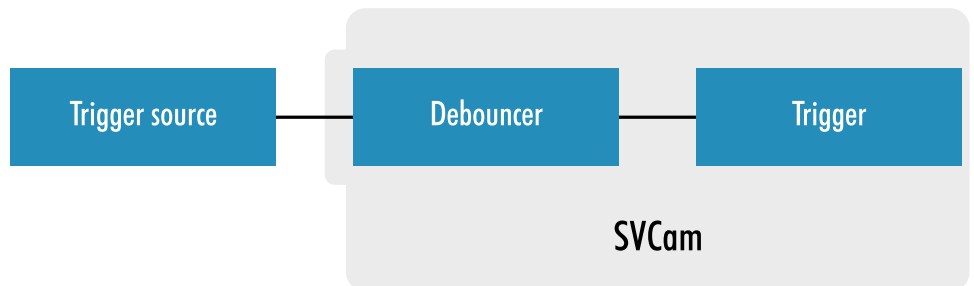
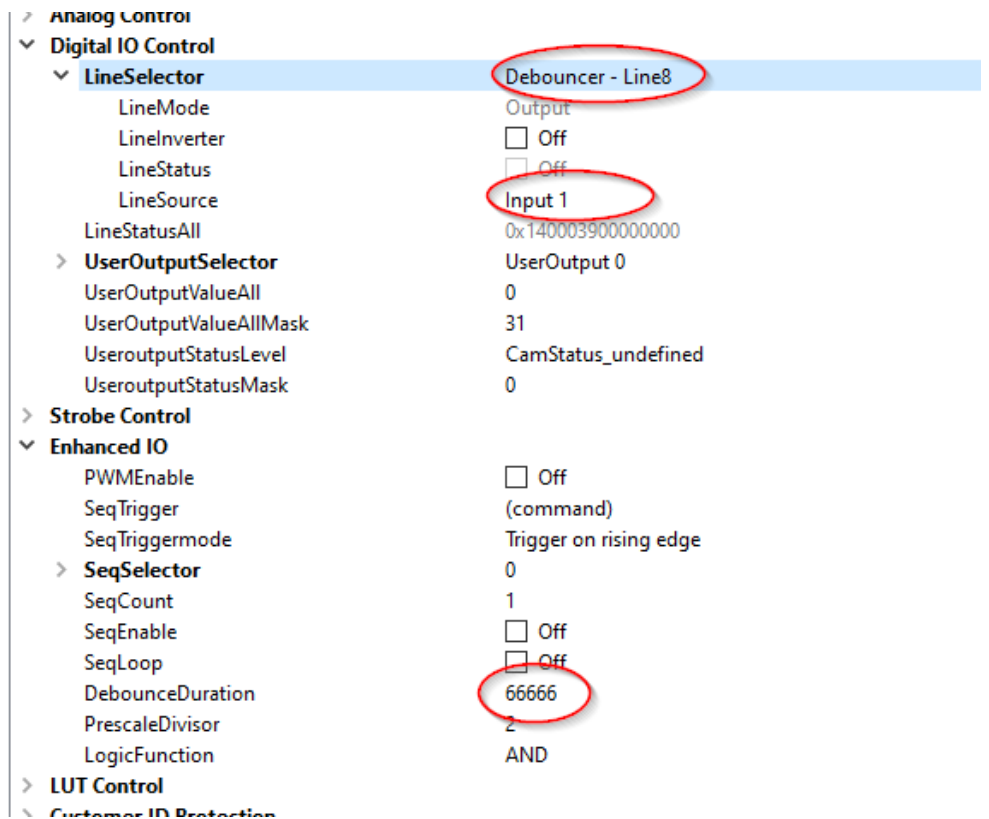

Fig. 5-47: Debouncer between the trigger source and trigger



1. Use the IO Assignment tool to place and enable the debouncer module in between the “trigger” (Schmitt trigger) and the input source (e.g.: line 1).
2. Set the register “DebounceDuration” in multiples of 15 ns (implementation of system clock), e.g. 66 666 \approx 1 ms.

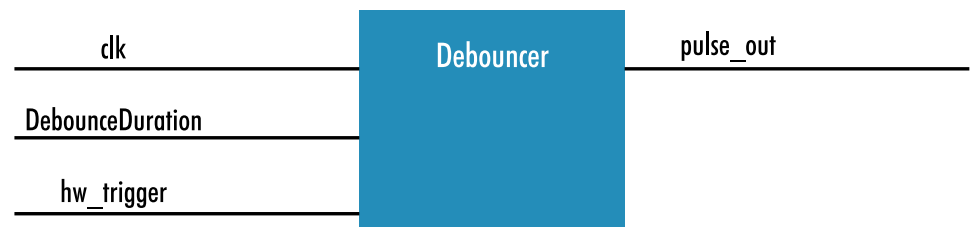

Fig. 5-48: The debouncer module

5.3.9

Prescale

The prescale function can be used for masking off input pulses by applying a divisor with a 4-bit word, resulting in 16 unique settings.

- Reducing count of interpreted trigger signal
- Use the prescale function to ignore a certain count of trigger signals.
- Divide the amount of trigger signals by setting a divisor.
- Maximum value for prescale divisor: is 16 (4 bit)

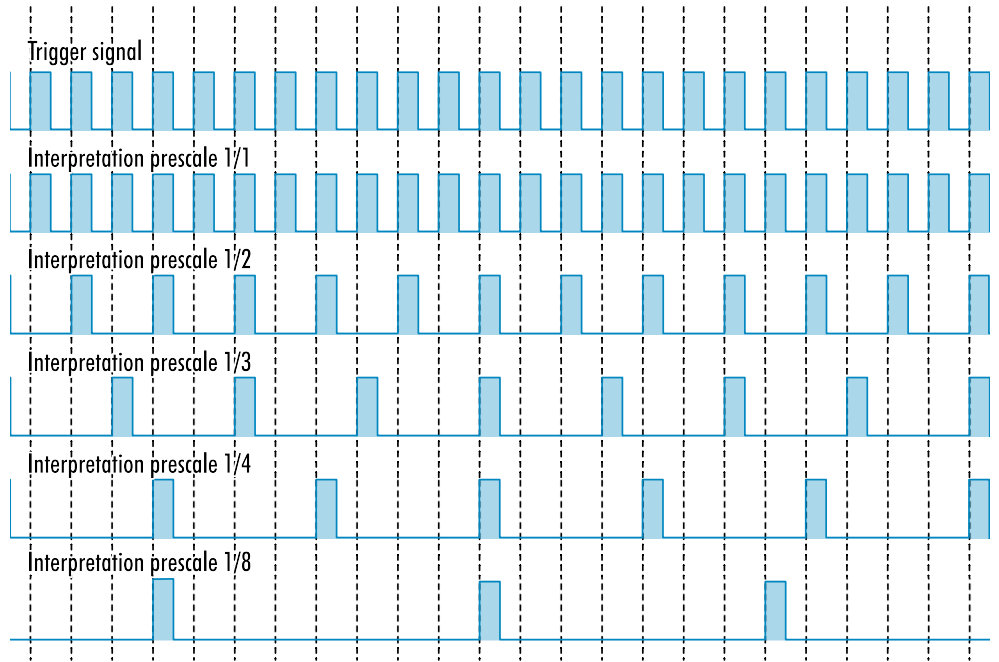

Fig. 5-49: Prescale values and their result on trigger signal

THE PRESCALE MODULE



Fig. 5-50: The prescale module

Annex

6.1 Dimensions

All length units in mm.

Find the technical drawings in the web download area at [Documents and downloads - Technical documentation](#)

6.2 I/O driver circuit schematics

Camera power supply and power supply for PWM out is 25V max., both being camera outputs.

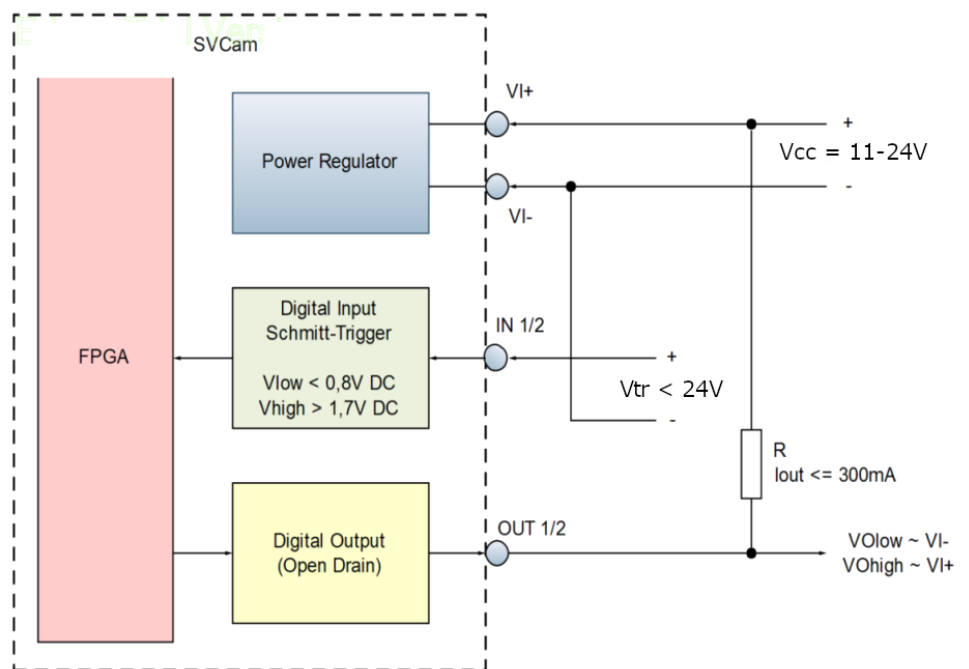

Fig. 6-1: I/O driver circuit schematics

6.3 25 GigE hardware recommendations

6.3.1 Cables

The cables must fit to the transceiver type, i.e. a single mode cable must be used with a single mode transceiver type.

This also applies to multi mode transceivers and cables.

SINGLE MODE

- One thicker fiber per lane
- For long range use cable length up to 10000 m
- Different classifications available
- Recommendation: OS2 classification

MULTI MODE

- Bundle of small fiber per lane
- For short range use cable length up to 100 m
- Different classifications available
- Recommendation: minimum OM4 classification

We recommend using single mode cables because they are more reliable, and the classification has less options than multi mode.

6.3.2 Requirements Mellanox ConnectX card

- We recommend plugging the Mellanox ConnectX card into the top PCIe slot.
- For full performance, a mainboard with PCIe Gen3/4 should be used.
- 16GB RAM, fast SSD and a newer generation Intel CPU (i5 and higher) is also recommended.

TYPES OF TRANSCEIVERS

Transceiver type	Single / multi mode	Wiring	Max. data rate
SFP+	Both options available	Fiber / copper (RJ45 Cat7)	10 Gbit/s
SFP28	Both options available	Fiber	25 Gbit/s
QSFP28	Both options available	Fiber	100 Gbit/s

SFP28 TRANSCEIVER MODULE TYPES FOR 25 GIGE

Short range

- Cable length up to 100 m
- Multi mode fiber @850nm
- Recommendation: MMA2P00-ASHT (<https://www.fs.com/de-en/products/71007.html?attribute=3271&id=1873065>)

Long range

- Cable length up to 10.000 m
- Single mode fiber @1.310 nm
- Recommendation: SFP28-25G-LR-31-I (<https://www.fs.com/de/products/97272.html?attribute=69216&id=1794365>)

6.3.4

Recommended components

	Transceiver type	Transceiver order no.	Cable order no.	Network interface card type	Comments
25 Gb/s	SFP28 (Single mode)	SFP28-25G-LR-31-I (KAB-SFP28-25GLR-31-I)	Single mode fiber cable with OS2 classification LC UPC, e.g. KAB-SM-LCU-LCU-DX-05	NVIDIA Mellanox ConnectX- 6 Lx with Rivermax license	Recommended cable length up to 10000 m industrial version of SFP28 module: higher temperature range (-40 °C to +85 °C)
	SFP28 (Single mode)	FS for Mellanox MMA2L20-AR	Single mode fiber cable with OS2 classification, e.g. KAB-SM-LCU-LCU-DX-05	NVIDIA Mellanox ConnectX- 6 Lx with Rivermax license	Cable length >100 m up to 10000 m
	SFP28 (Multi mode)	FS for Mellanox MMA2P00-ASHT	Multimode fiber cable with minimum classification OM4	NVIDIA Mellanox ConnectX- 6 Lx with Rivermax license	Cable length <100 m
10 Gb/s	SFP+ (Multi mode)	SFP-10GSR-85	Multimode fiber cable with minimum classification OM4	NVIDIA Mellanox ConnectX- 6 Lx with Rivermax license	Up to 400 m
	SFP+ (RJ45)	SFP-10G-T	CAT 7 / KAB-GIGE-CHAIN-CAT7-XX*	NVIDIA Mellanox ConnectX- 6 Lx with Rivermax license	Up to 30 m
			CAT 7 / KAB-GIGE-SCREW-XX-CAT7*	NVIDIA Mellanox ConnectX- 6 Lx with Rivermax license	Up to 30 m

*XX = length in m, by selecting the order code of the components you will be forwarded to the online shop of www.fs.com

6.4 Action commands

Action commands are dedicated Ethernet packets used as external so called "Trigger over Ethernet" (ToE). The trigger can be sent to one camera as unicast or to all cameras as broadcast.

Each action command contains the following values:

- **DeviceKey** to authorize the action on this device.
- **GroupKey** to define a group of devices on which actions have to be executed.
- **GroupMask** to be used to filter out some of these devices from the group.

All these values can be set here:



Fig. 6-2: Action control

To fire a trigger in the camera, the DeviceKey and the GroupKey have to match and at least one bit in the GroupMask has to match.

Here are some examples of the GroupMask:

Sent GroupMask	Camera GroupMask	Camera reaction
0x7FFF FFFF	0x0000 0001	YES
0x0000 000E	0x0000 0001	NO
0x0000 FFFF	0x0000 005F	YES
0x0000 FFFF	0x0000 0800	YES
0x0000 FFFF	0x0f11 0000	NO

Table: 6-1: Examples of GroupMask

Here are some examples of action commands "ActionCMD" and the reaction of three cameras receiving these commands:

	ActionCMD	Device0	Device1	Device2
DeviceKey	0xaffe	0xaffe	0xaffe	0xaffe
GroupKey	0x1234	0x1	0x1234	0x1234
GroupMask	0x0002	0x0001	0x0002	0x0001

ActionCMD	Device0	Device1	Device2
	invalid	valid	valid
DeviceKey	0xaffe	0xaffe	0xaffe
GroupKey	0x0001	0x1234	0x1234
GroupMask	1-65535	0xffff	0xffff
	valid	invalid	invalid

Table: 6-2: Example of action command

A short Python program example to generate an action command. The IP address of "server.bind" shall be adapted to the IP address of the local network card.

```

1 import socket import time
2 from struct import *
3 server = socket.socket(socket.AF_INET, socket.SOCK_DGRAM, socket.IPPROTO_UDP)
4 server.setsockopt(socket.SOL_SOCKET, socket.SO_REUSEADDR, 1)
5 # Enable broadcasting mode server.setsockopt(socket.SOL_SOCKET, socket.SO_
6 BROADCAST, 1) server.settimeout(0.2)
7 # use local address to bind socket server.bind(("169.254.191.50", 44444))
8 #message = b"your very important message" # net8 id;
9 #net8 flag; #net16 command; #net16 length; #net16 req_id; #net32 device_key;
10 #net32 group_key; #net32 group_mask;
11 # gv_cmd_action;
12 # action ack request
13 # id flag command length req_id device_key group_key
14 group_mask
15 message = pack("!BBhhhlll", 0x42, 0x01, 0x0100, 12, 5, 1, 1, 1)
16 # without action ack request
17 #message = pack("!BBhhhlll", 0x42, 0x00, 0x0100, 12, 5, 1, 1, 1)
18 while True:
19 server.sendto(message, ('<broadcast>', 3956))
20 #server.sendto(message, ("169.254.185.58", 3956))
21 print(".") time.sleep(1/40)

```

Generating an action command

The time between receiving an action command and releasing the trigger was measured with maximum load and values between 25605 ns and 50130 ns.

6.5

FAQ

For questions and issues, refer to the FAQ page on our website: [FAQs and application notes](#)



Allied Vision Gilching GmbH

Ferdinand-Porsche-Str. 3

82205 Gilching

Phone: +49 8105 3987-60

www.alliedvision.com

info@alliedvision.com

© March, 2026