

## TECHSPEC® 35mm Focal Length, HP Series Fixed Focal Length Lens

#86-573



35mm Focal Length, #86-573

TECHSPEC® HP Series Fixed Focal Length Lenses are designed for the harsh demands of [factory automation \(FA\)](#) and machine vision (MV) applications. The 8mm, 12mm, 16mm, 25mm, and 35mm lenses are compatible with 1" and 1.1" sensor formats, while the 50mm lens is compatible with up to 4/3" sensor formats. The f/1.8 and f/2.8 apertures provide increased light throughput and high resolution performance. TECHSPEC® HP Series Fixed Focal Length Lenses are C-Mount and feature a locking focus and iris rings to prevent unwanted adjustments, as well as a front filter thread for integrating standard optical filters. Call for OEM Quantity Pricing.

Outer Diameter (mm):	48.1
Type:	Fixed Focal Length Lens
Coating:	$\lambda/4$ MgF <sub>2</sub>
Maximum Length (mm):	65.8
Minimum Length (mm):	60
Imaging Lens Type:	High Performance Lens
Storage Temperature (°C):	-20 to +60 For questions regarding operating temperature please contact our support team

### Optical

Horizontal Field of View, 1/2" Sensor:	41.4mm - 10.4°
Horizontal Field of View, 2/3" Sensor:	57.0mm - 14.3°
Horizontal Field of View, 1/3" Sensor:	31.0mm - 7.8°
Horizontal Field of View, 1" Sensor:	83.4mm - 20.7°
Maximum Image Circle (mm):	17.60
Numerical Aperture NA, Object Side:	0.0402
Horizontal Field of View @ Max Sensor Format:	92.8mm - 22.9°
Horizontal Field of View, 1.1" Sensor:	92.8mm - 22.9°
Horizontal Field of View, 1/1.8" Sensor:	46.6mm - 11.7°
Horizontal Field of View, 1/2.5" Sensor:	37.5mm - 9.5°
Focal Length FL (mm):	35.00
Primary Magnification PMAG:	0.155
Maximum Sensor Format:	1.1"
Working Distance (mm):	200 - ∞
Aperture (f/#):	f/1.8 - f/16
Distortion (%):	<-1.5
Coating Specification:	λ/4 MgF <sub>2</sub>
Entrance Pupil Position (mm):	36.78
Horizontal Field of View, 1/4" Sensor:	23.2mm - 5.9°
Object Space Principal Plane (mm):	55.84
Image Space Principal Plane (mm):	-19.36
Field of View at Max Sensor Format:	Horizontal: 92mm - 22.7° Vertical: 68.6mm - 17.1° Diagonal: 116.1mm - 28.1°
Maximum Distortion (%):	0.47
Exit Pupil Position (mm):	-61.22
Lens Wavelength Range:	VIS

## Mechanical

Iris Option:	Variable
Length (mm):	70.97
Filter Thread:	M37 x 0.75 (Female)
Maximum Diameter (mm):	48.1
Weight (g):	226
Maximum Rear Protrusion (mm):	1.06
Number of Elements (Groups):	7 (6)
Mount:	C-Mount

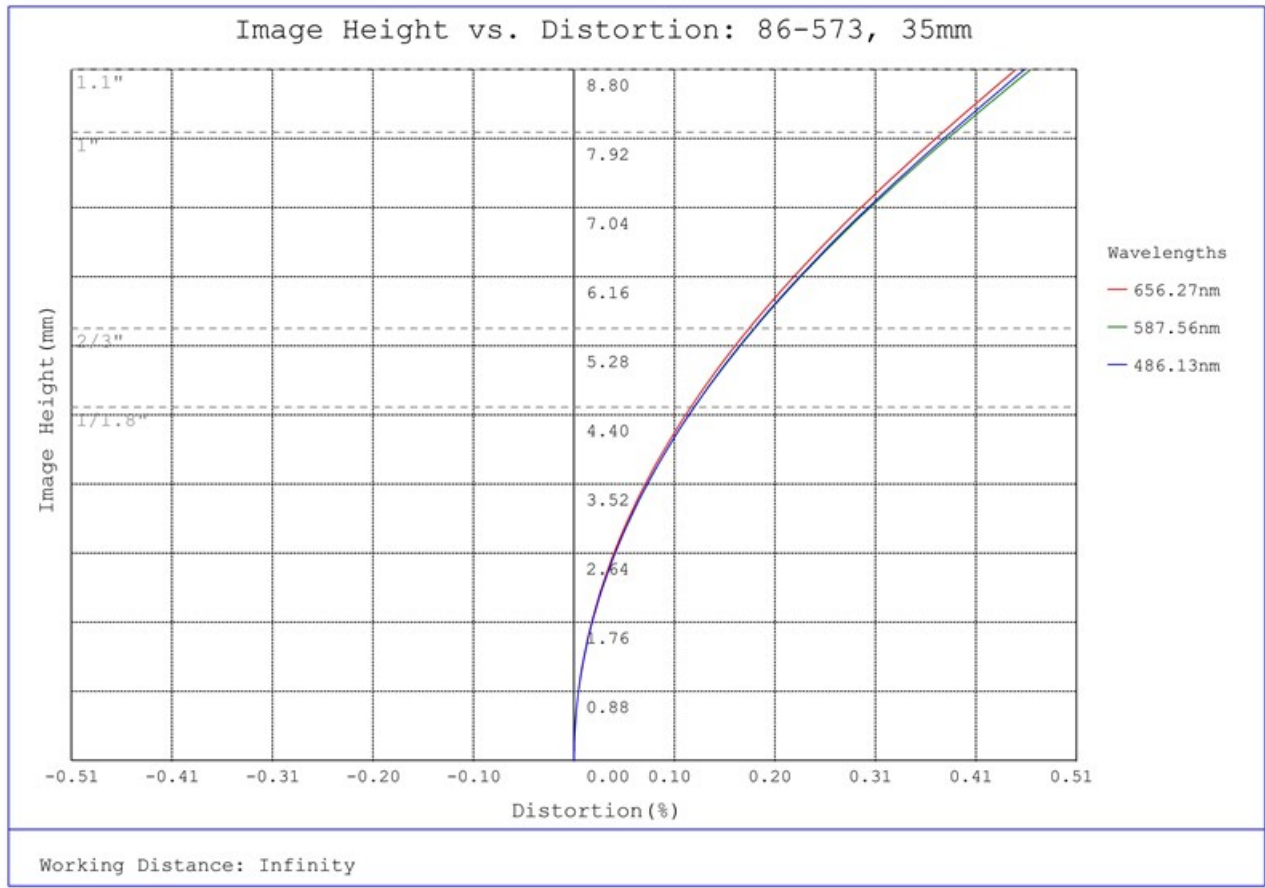

#86-573, 35mm Focal Length, HP Series Fixed Focal Length Lens, Distortion Plot

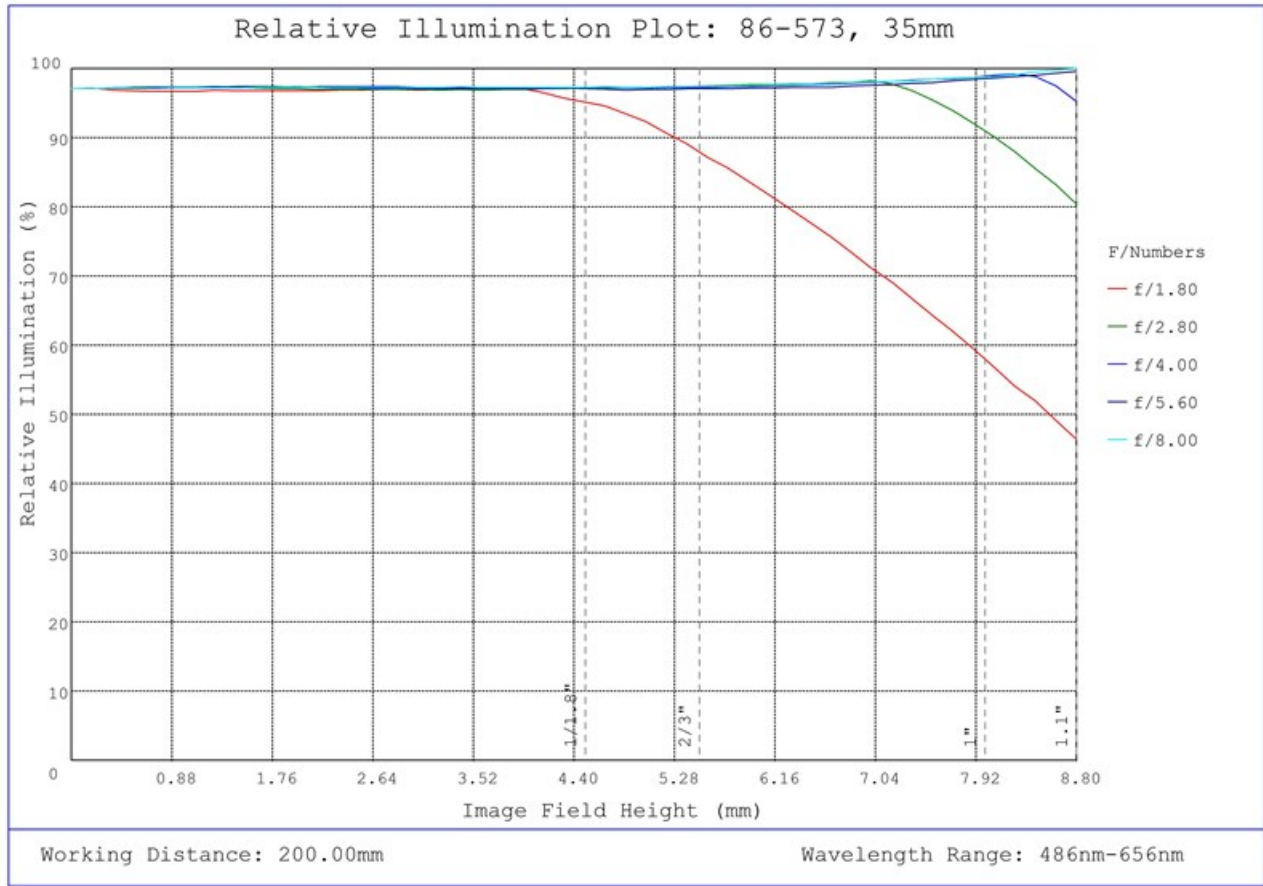

#86-573, 35mm Focal Length, HP Series Fixed Focal Length Lens, Relative Illumination Plot

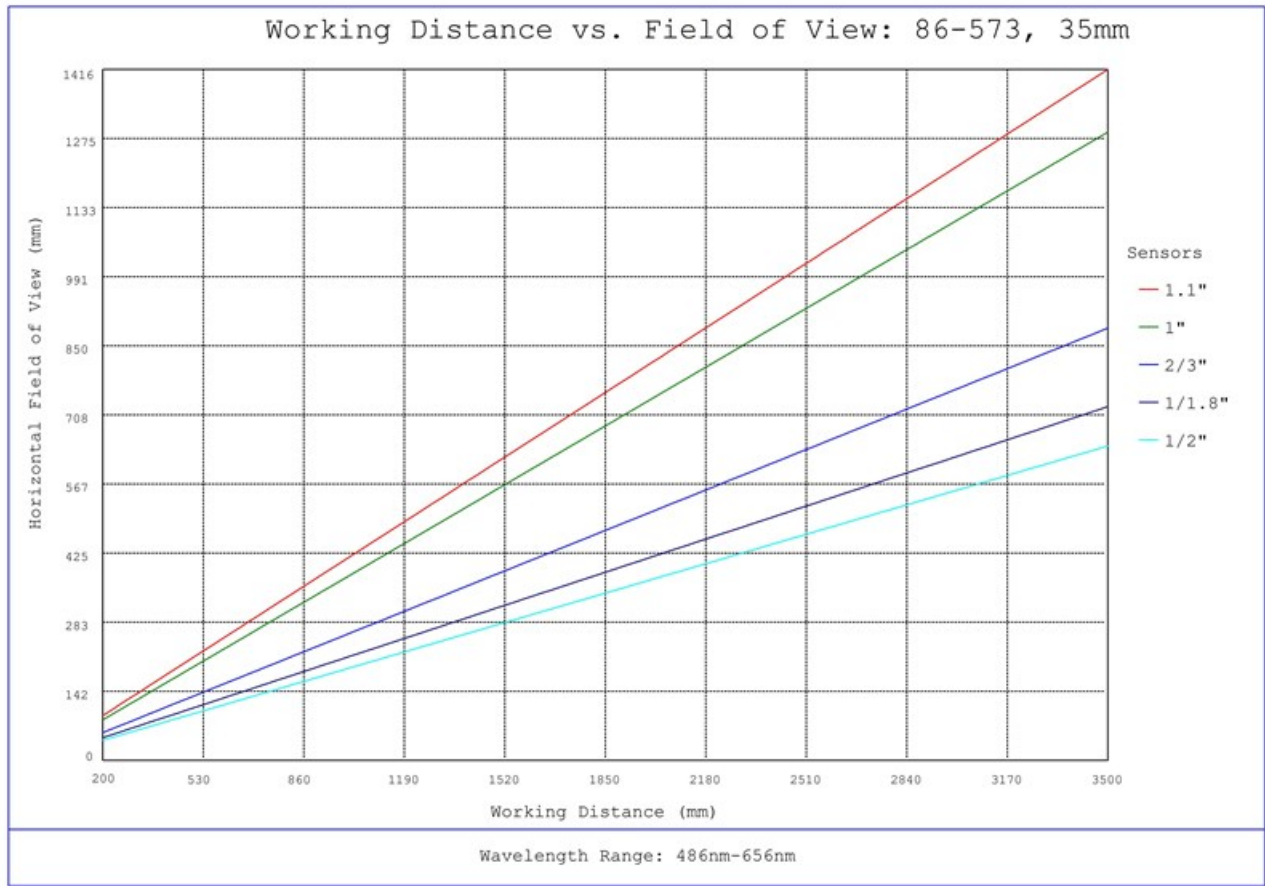

#86-573, 35mm Focal Length, HP Series Fixed Focal Length Lens, Working Distance versus Field of View Plot

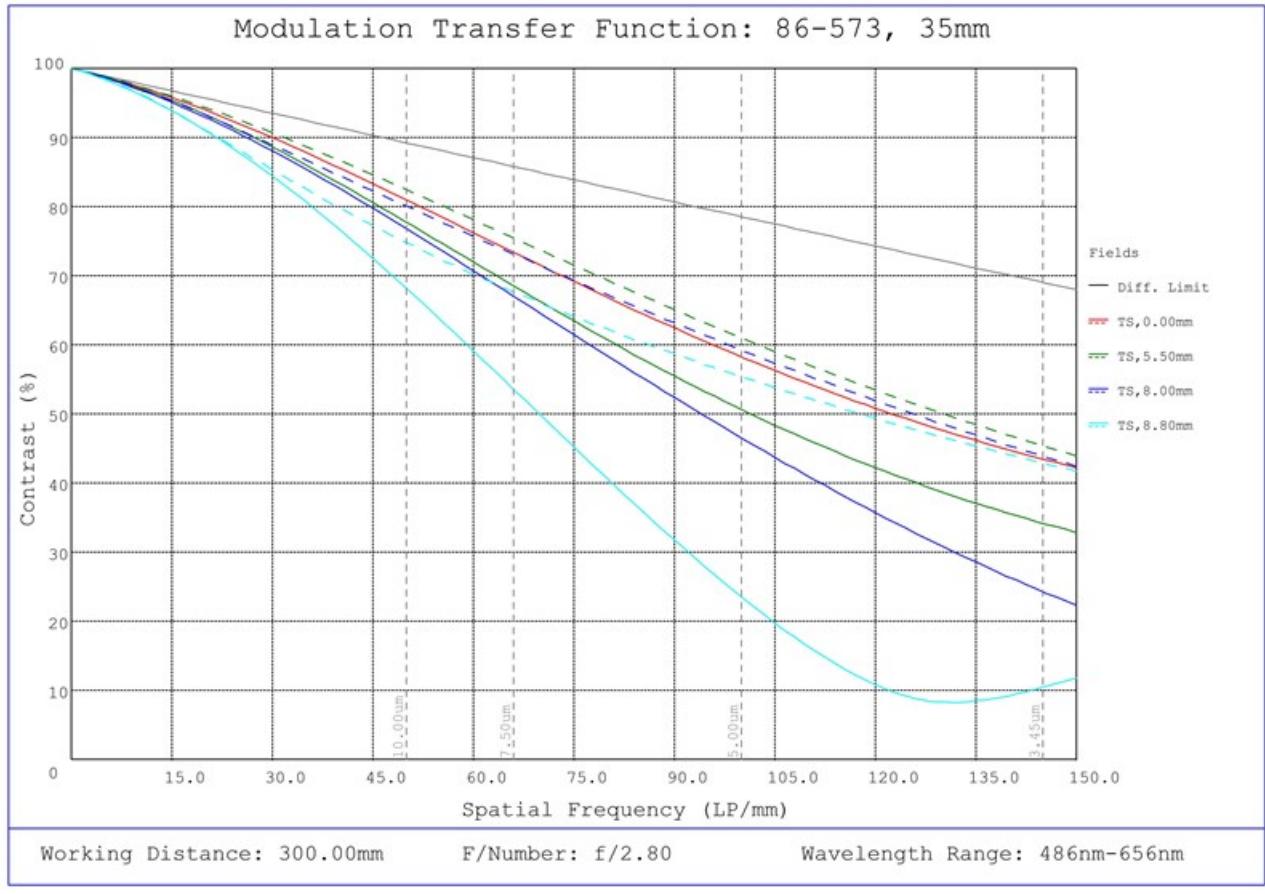

#86-573, 35mm Focal Length, HP Series Fixed Focal Length Lens, Modulated Transfer Function (MTF) Plot, 300mm Working Distance, f2.8





#86-573, 35mm Focal Length, HP Series Fixed Focal Length Lens, Depth of Field Plot, 300mm Working Distance, f2.8

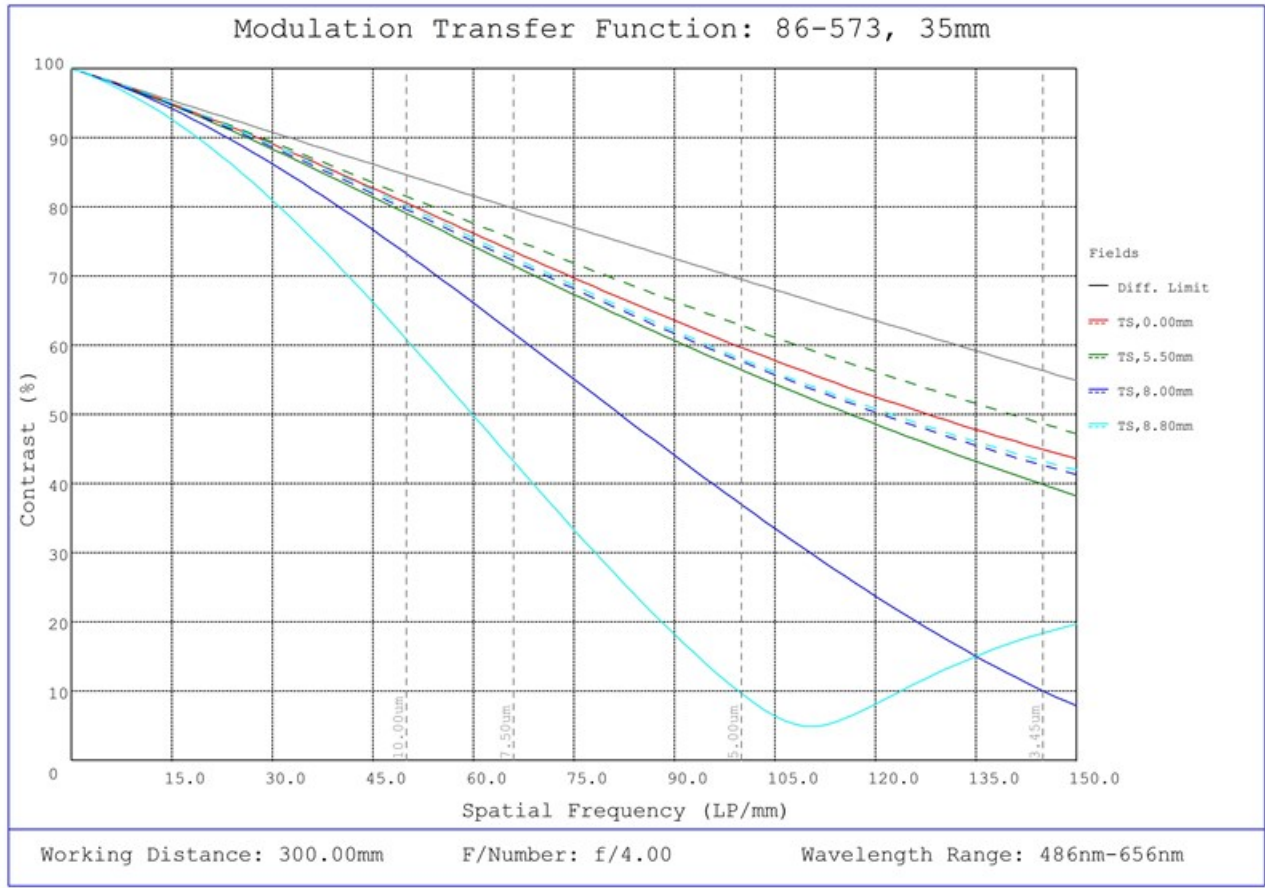

#86-573, 35mm Focal Length, HP Series Fixed Focal Length Lens, Modulated Transfer Function (MTF) Plot, 300mm Working Distance, f4



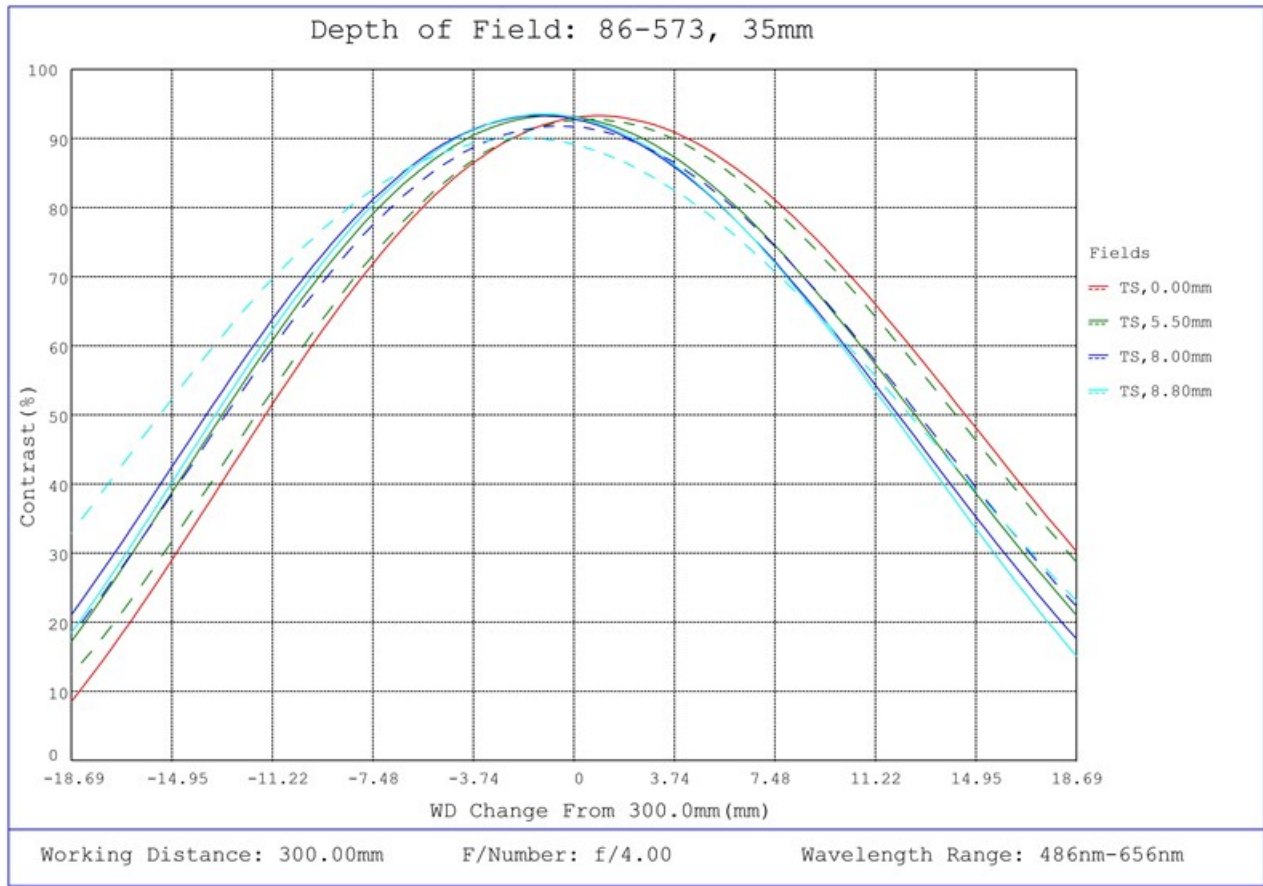

#86-573, 35mm Focal Length, HP Series Fixed Focal Length Lens, Depth of Field Plot, 300mm Working Distance, f4

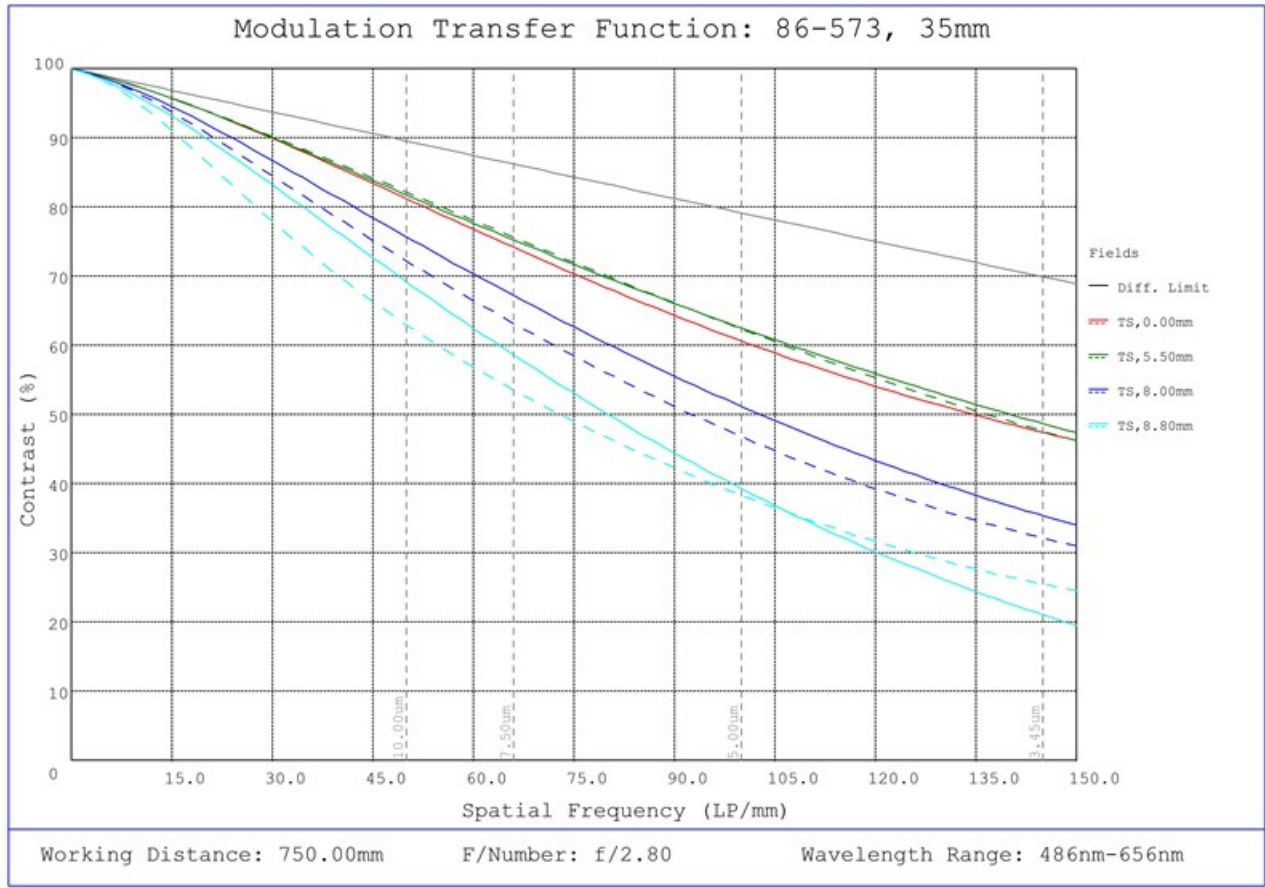

#86-573, 35mm Focal Length, HP Series Fixed Focal Length Lens, Modulated Transfer Function (MTF) Plot, 750mm Working Distance, f2.8

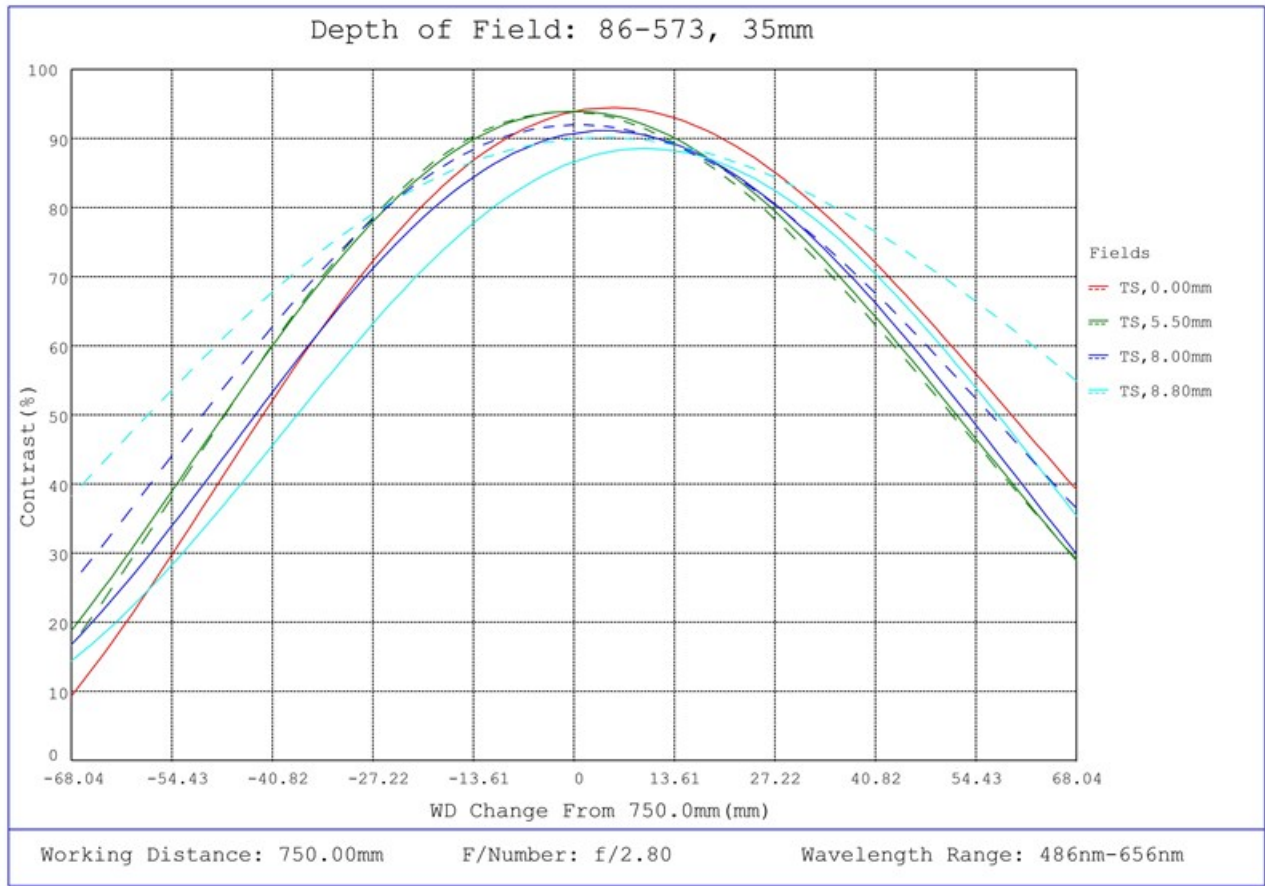

#86-573, 35mm Focal Length, HP Series Fixed Focal Length Lens, Depth of Field Plot, 750mm Working Distance, f2.8

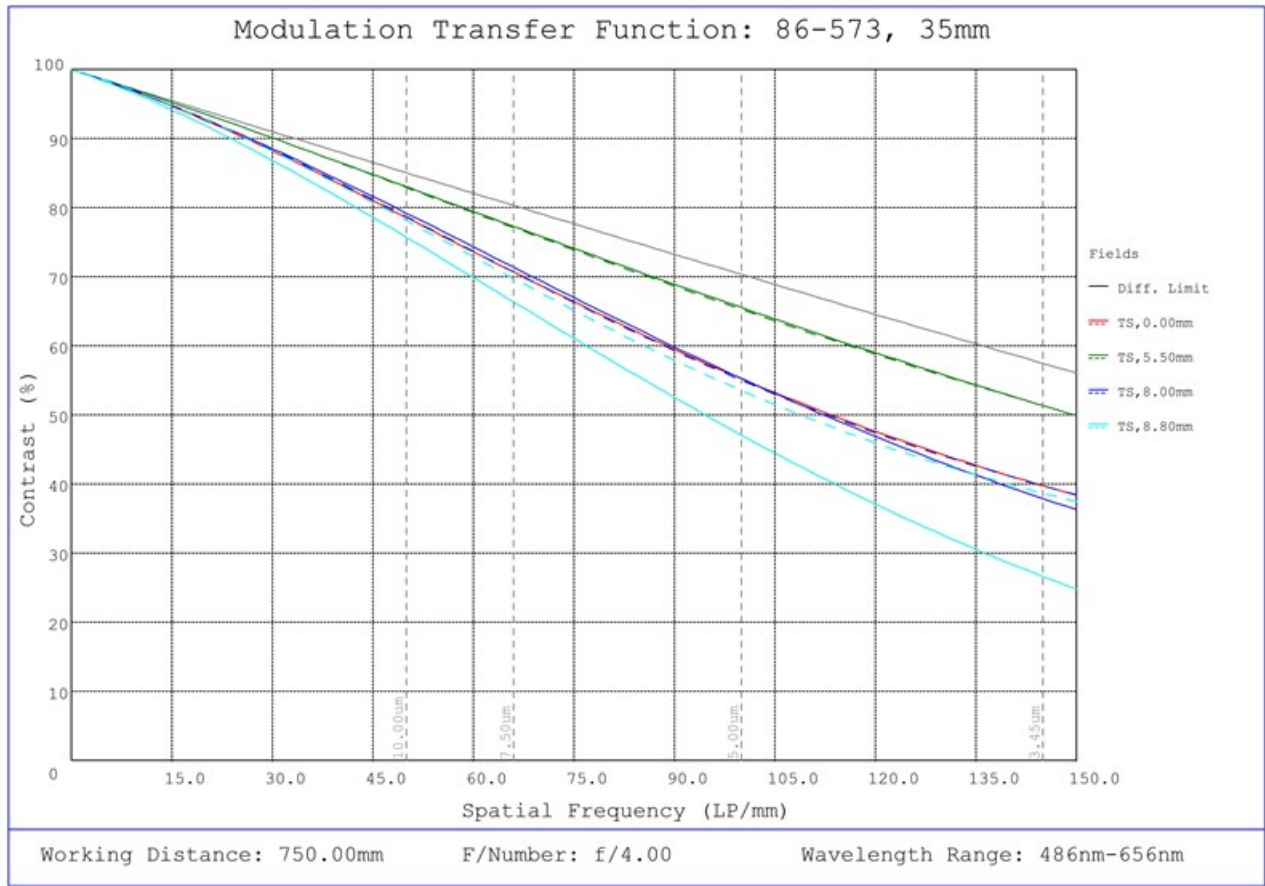

#86-573, 35mm Focal Length, HP Series Fixed Focal Length Lens, Modulated Transfer Function (MTF) Plot, 750mm Working Distance, f4

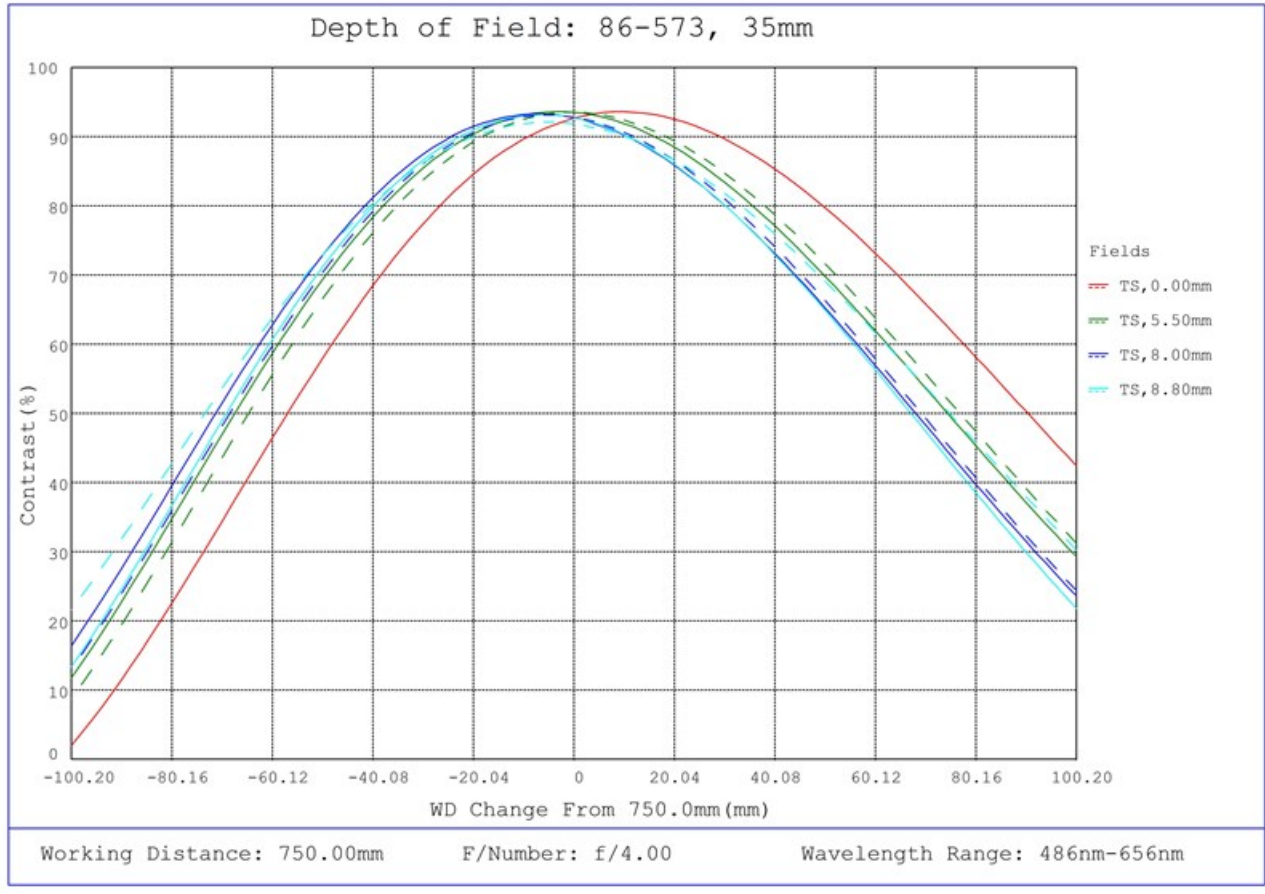

#86-573, 35mm Focal Length, HP Series Fixed Focal Length Lens, Depth of Field Plot, 750mm Working Distance, f4

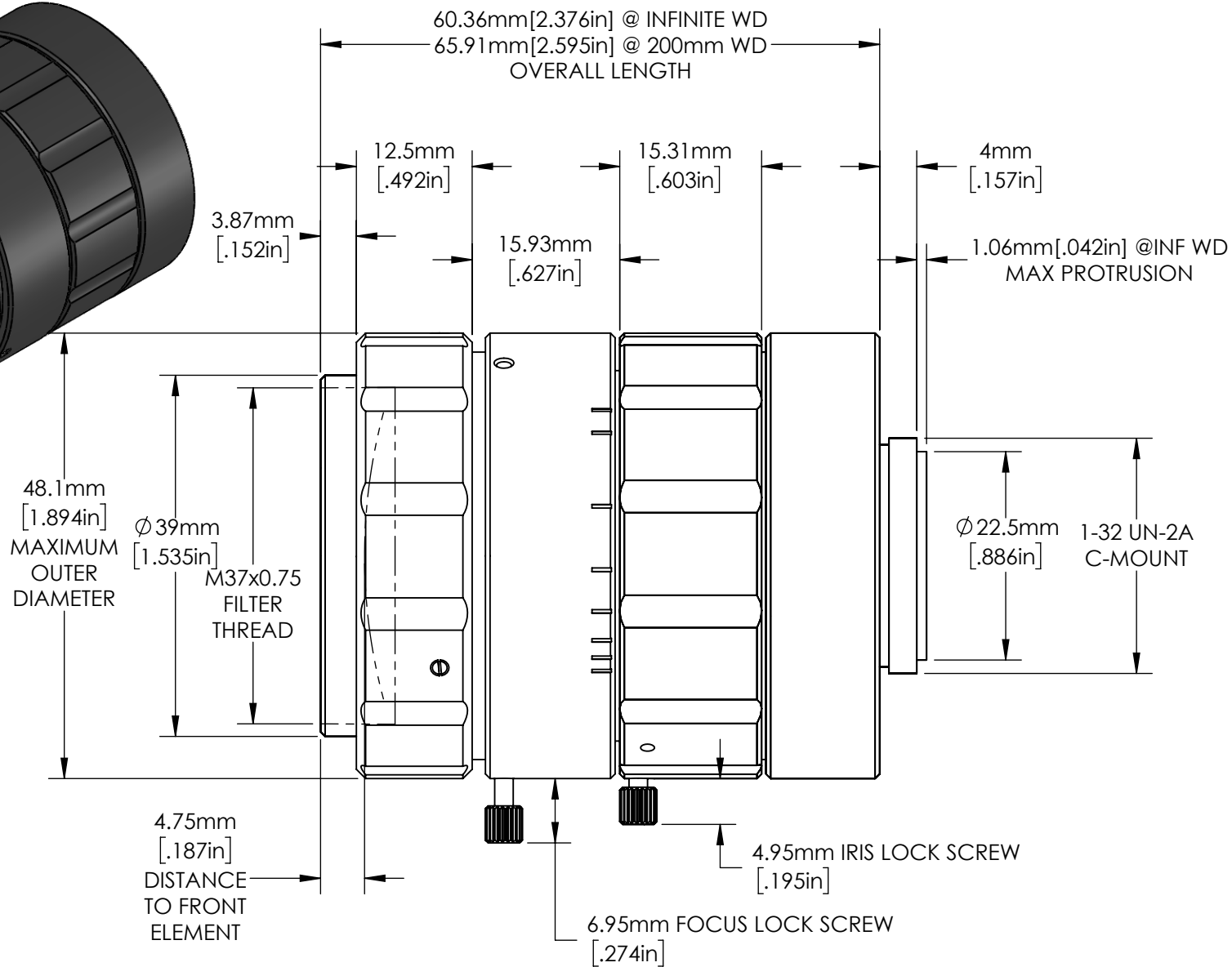
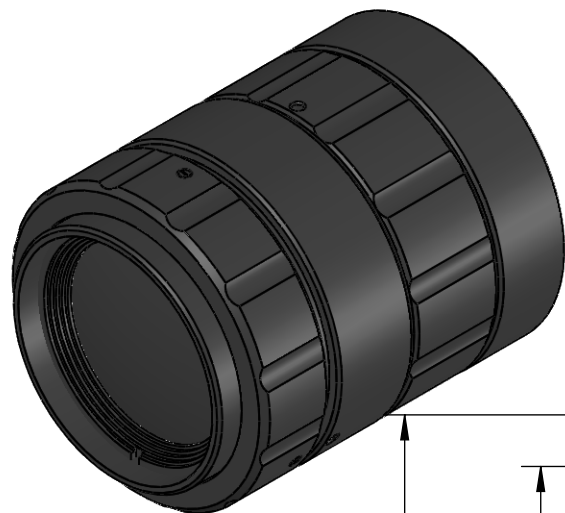

**FOR INFORMATION ONLY:  
DO NOT MANUFACTURE  
PARTS TO THIS DRAWING**

SPECIFICATIONS SUBJECT TO CHANGE  
WITHOUT NOTICE.  
DIMENSIONS ARE FOR REFERENCE ONLY.  
FOR DETAILED SPECIFICATIONS,  
PLEASE REFER TO THE SPEC SHEET.

**EO**® Edmund Optics®

TITLE	35mm Focal Length, HP Series Fixed Focal Length Lens		
DWG NO	86573		SHEET 1 OF 1







June 09, 2023

To Whom It May Concern,

This document certifies that the product stated below has been reviewed as requested by Edmund Optics:

<i>Stock No.</i>	<i>Description</i>
86-573	35mm Focal Length, HP Series Fixed Focal Length Lens

This item is EU RoHS (2015/863/EU) compliant without the use of exemptions.

This certification means that:

- EO's suppliers have confirmed the material composition of this product.
- EO has implemented rigorous procedures to document this compliance.
- The information provided may, or may not, be based upon actual test data, or on information from our Vendors, Raw Material Suppliers or Subcontractors.

A handwritten signature in cursive script, appearing to read 'J. Budd'.

Jay Budd, Director of Corporate Compliance

June 09, 2023

Edmund Optics Inc. - 101 E Gloucester Pike, Barrington, NJ 08007 | 1-800-363-1992 | [Compliance@edmundoptics.com](mailto:Compliance@edmundoptics.com)



June 09, 2023

To Whom It May Concern,

This document certifies that the product stated below has been reviewed as requested by Edmund Optics:

<i>Stock No.</i>	<i>Description</i>
86-573	35mm Focal Length, HP Series Fixed Focal Length Lens

This item does not contain any of the substances listed on the Reach SVHC list as of 25 June 2020 in quantities exceeding 0.1% weight by weight.

Please note the following:

- Entry 11 of Annex V of the REACH regulation as amended by regulation 987/2008, exempts “non-hazardous” glass components from registration.
- Items considered to be packing materials and which do not form part of, or are not required for the operation of, the product, are not considered to be within scope of this declaration.
- EO does not routinely analyze products for substances not purposely added or specified within the design specifications, drawings and assembly procedures.

This certification means that:

- EO's suppliers have confirmed the material composition of this product.
- EO has implemented rigorous procedures to document this compliance.
- The information provided may, or may not, be based upon actual test data, or on information from our Vendors, Raw Material Suppliers or Subcontractors.

A handwritten signature in cursive script, appearing to read 'Jay Budd'.

Jay Budd, Director of Corporate Compliance

June 09, 2023

Edmund Optics Inc. - 101 E Gloucester Pike, Barrington, NJ 08007 | 1-800-363-1992 | [Compliance@edmundoptics.com](mailto:Compliance@edmundoptics.com)



June 09, 2023

<i>Stock No.</i>	<i>Description</i>
86-573	35mm Focal Length, HP Series Fixed Focal Length Lens

Edmund Optics certifies that all articles included in this shipment are in compliance with the terms and conditions of this order. The company also certifies that the articles included in this shipment are in accordance to all agreed upon specifications and quality assurance provisions. Please call 1-800-363-1992 should any questions arise from this shipment.

A handwritten signature in black ink, appearing to read 'Jeff Harvey'.

Jeff Harvey- EVP of Operations