

EXTRA
SMALL

USB uEye[®]XS



Your imagination is our challenge

USB uEye®XS



Actual size shown here

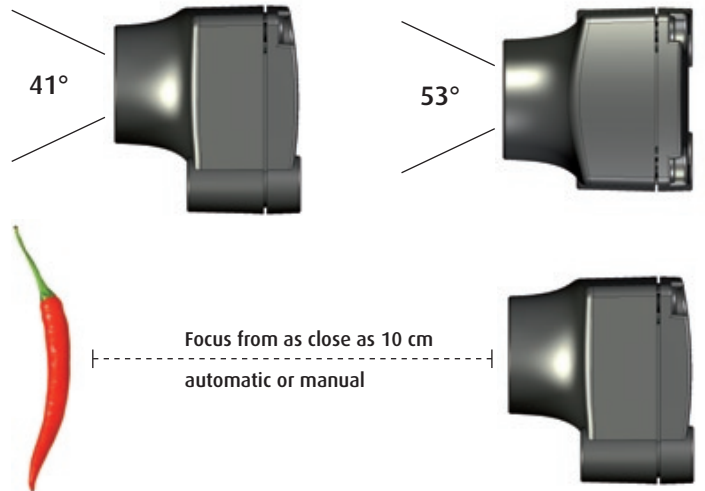

At a glance:

- **Ultra-compact:**
26.5 x 23 x 23.75 mm (H x W x D)
- 8 Megapixel Color CMOS Sensor
- Lightweight, robust magnesium housing
- HDTV 720p live video with 15 frames/sec.
- Integrated Autofocus lens with 35 mm focal length (35 mm equivalent)
- Focus range: 10 cm to infinity
- Live face detection of up to four faces
- Electronic image stabilization
- Internal color conversion (YUV)
- Automatic controls for ISO, exposure time, white balance
- Drivers and SDK for Windows
- Demo programs in C++, C# and VB.NET
- 32 and 64 bit drivers

Do you have a lot of ideas, but not much space?

This USB 2.0 camera is full of smart features in a package less than 1 cubic inch in size. This compact camera comes with the latest in CMOS sensor technology, an integrated autofocus lens and a DSP. It has a rich set of features that until recently were only available in consumer digital still cameras. Thanks to the USB uEye XS, many of these performance features are now available in a professional USB camera that comes with an SDK and has a long term availability.

	Resolution*	Frame rate
Live Video		
720p	1280 x 720	15 fps
Ultra WVGA	960 x 480	30 fps
WVGA	800 x 480	30 fps
VGA	640 x 480	30 fps
CIF	320 x 240	30 fps

* extract



Small, clever and smart

Live face detection

The uEye XS can detect and track up to four faces while in live acquisition mode. It does so while returning the location, the size and the viewing angle of each face. An option to highlight each face with an overlay is also available.

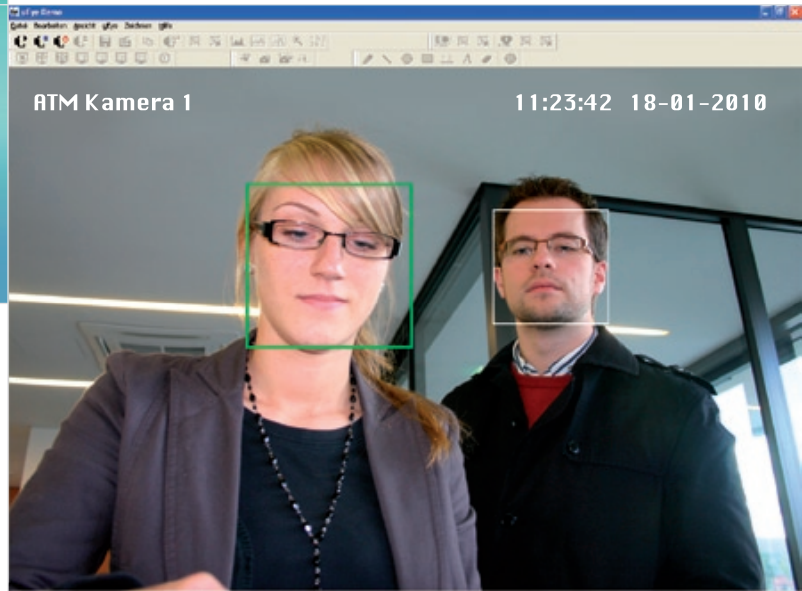

Automatic image controls

Optimum settings for every situation – no need to fiddle with configurations. The uEye XS features a host of functions for automatic image adjustment that adapt to the exposure time, white balance and ISO (gain) parameters in real time. In addition, you can fine tune the auto image adjustment feature by tweaking the measurement fields through the uEye SDK.



Autofocus lens

The integrated autofocus lens, which features a horizontal viewing angle of 53° (equivalent to 35 mm focal length in the 35 mm format) can focus on objects from 10 cm to infinity. Through the uEye SDK, the user can control parameters such as speed and range to be set and the current focus position to be read out. The lens focus can also be controlled manually using the SDK.

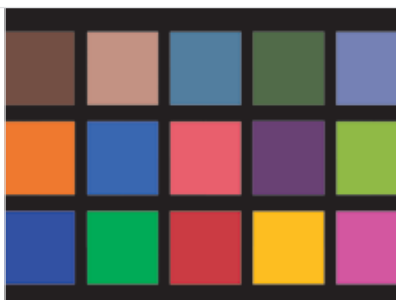

Internal color conversion

It has never been this easy to acquire color images with a professional USB camera. Image data from the uEye XS is converted to YUV by the built-in DSP, freeing up resources on the computer. And if you're acquiring from the uEye XS directly for visualization, edge enhancement and color correction can be used to make the images look even better.

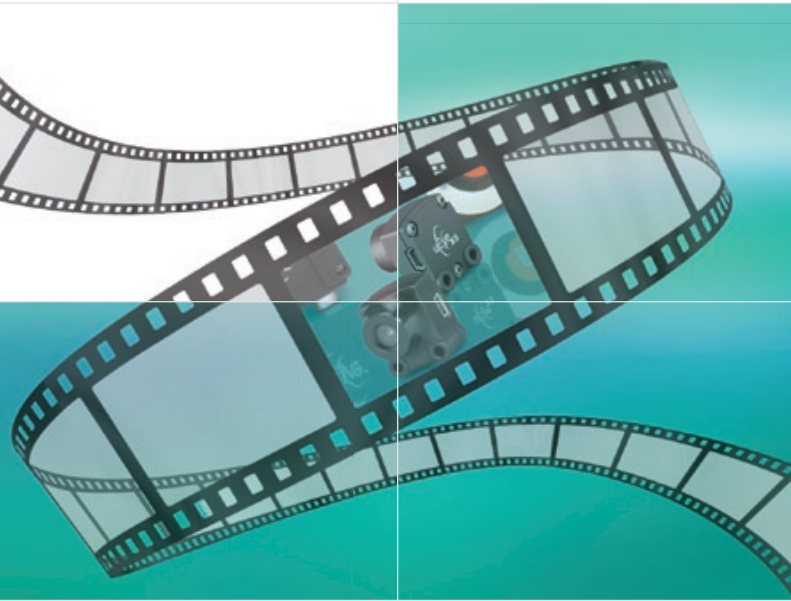

High-resolution live images and robust housing technology

HD video

The uEye XS reads out live video in a variety of sizes up to the HDTV resolution of 720 p (1,280 x 720 pixels) at a rate of 15 images per second. Up to 30 images per second can be readout with resolutions of 320 x 240 to 960 x 480 pixels. Binning and the built-in scaler make it possible to display the entire field of view in low resolutions.

Image stabilization

Thanks to its small size, the uEye XS is ideal for use on the go, e.g. in vehicles and portable devices. The uEye XS features electronic image stabilization to ensure optimum image quality even when the camera is moving. The camera can detect movements in the image background and effectively compensate for vibrations.

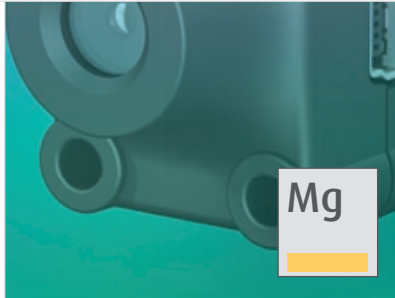

Magnesium housing

You can see that the uEye XS is well suited for professional use just by looking at its high production quality. The compact magnesium housing is lightweight, yet extremely robust. Using magnesium as the housing material ensures excellent EMC compatibility. The uEye XS can be securely attached to a variety of structures thanks to its two M3-size mounting holes.

Comprehensive software package

The comprehensive software package enables you to easily integrate the uEye XS into your application, whether it's through a standard interface like DirectShow, ActiveX or GenICam, through common image-processing libraries, or directly using the uEye API with 150 functions. Over 20 demo programs in C, C++ and C# make it easy to get started. All USB and GigE uEye cameras are driver-compatible, making it easy to integrate the uEye XS into existing applications.

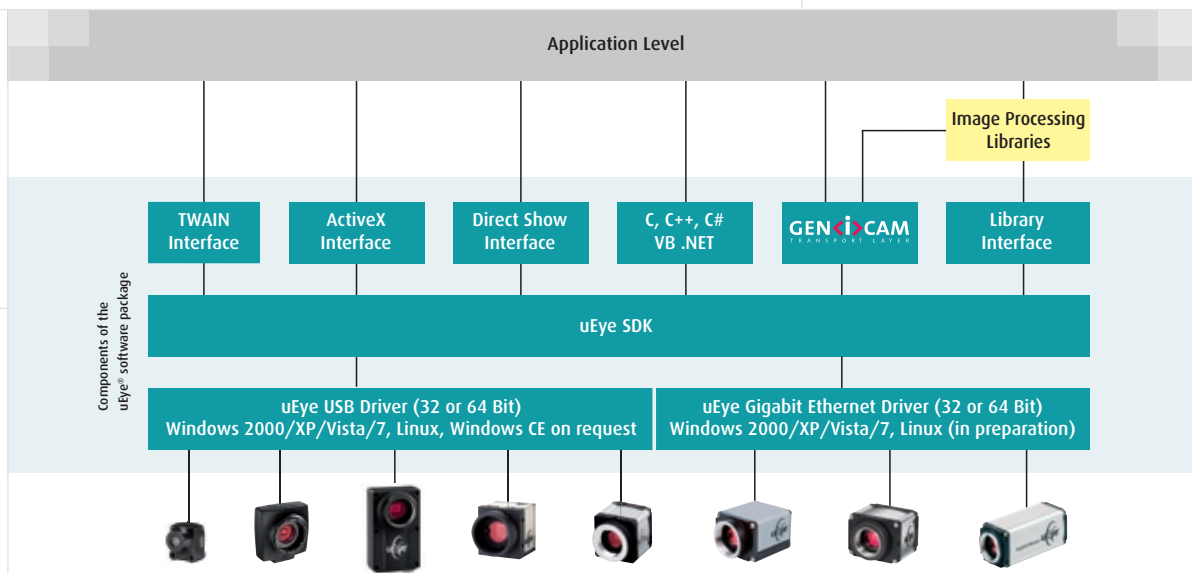

Features at a glance

- Ultra-compact:
26.5 x 23 x 23.75 mm
(H x W x D)
- 8 Megapixel Color CMOS Sensor
- Lightweight, robust magnesium housing
- HDTV 720p live video with
15 frames/sec.
- Integrated Autofocus lens with
35 mm focal length
(35 mm equivalent)
- Focus range: 10 cm to infinity
- Live face detection of up to
four faces
- Electronic image stabilization
- Internal color conversion (YUV)
- Automatic controls for ISO,
exposure time, white balance
- Drivers and SDK for Windows
- Demo programs in C++, C#
and VB.NET
- 32 and 64 bit drivers

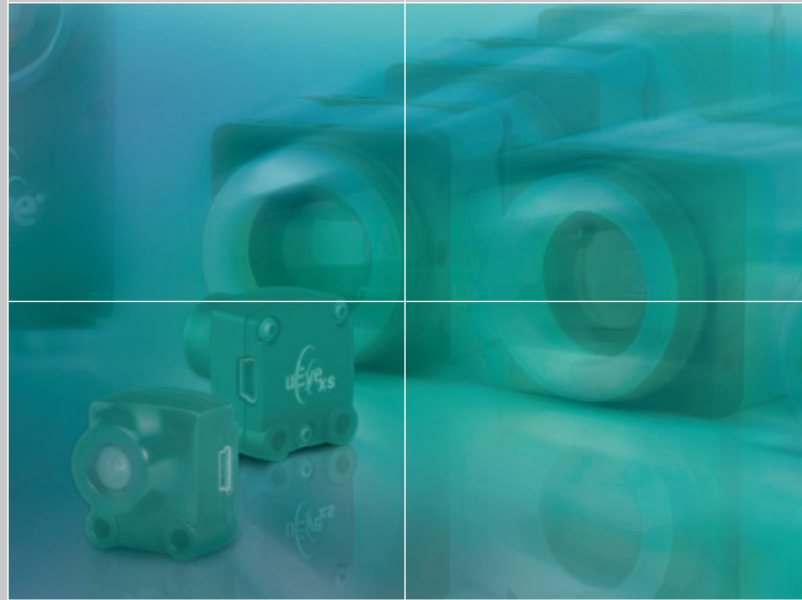

Scale 1:1 (USB uEye X5)

