



Powerful → 3.5 Millions Lux @ 5cm

Ideal for high-speed applications when high brightness is necessary

<b>Electronics</b>	Power supply	24V DC – 1.8 A – 45W (ELS-700) or 24V DC – 3 A – 70W (ELS-1000)
	Illumination mode	External trigger up to 15 kHz by analog voltage 0-24V or 0-5 V signal
	Connector	M12, 5 pins
	Power consumption	45 Watts @24V DC
<b>Optics</b>	Wavelength (nm)	365 / 395 / 405 / 465 / 525 / 625 / 850 / white (000)
<b>Mechanics</b>	Width and height	70.6mm x 65 mm x172 mm
	Weight	860g
	Material	Device body: Aluminum alloy
<b>Thermal</b>	Cooling system	Active air cooling with fan
<b>Environment</b>	Working temperature	0°C to 50°C
	Working humidity	≤ 80%
	IP code	IP40

## Part Number



<i>Reference:</i> EFFI-SPOT- <b>XXX</b> - <b>YYYYYYYY</b> - <b>ZZZ</b>							
<b>XXX</b> : Wavelength (nm)							
● UV 365	● UV 395	● UV 405	● Blue 465	● Green 525	● Red 625	● IR 850	○ White 000 (T°= 5500 K ± 500 K)
<b>YYYYYYYY</b> : Electronic version (If not specified, default ELS-1000)							
<b>ELS-700</b> : 700mA				<b>ELS-1000</b> : 1000mA (Not available for Red LED)			
<b>ZZZ</b> : Analog DIM Voltage (V) (if not specified, default 24V)							
<b>24V</b>	0V – OFF (0%)	4.5V to 24V – 20% to 100%				24V – ON (100%)	
<b>5V</b>	0V – OFF (0%)	1.5V to 5V – 20% to 100%				5V – ON (100%)	

## Electronical considerations



### Contact arrangement

The EFFI-SPOT is supplied with a 24V constant voltage source (Using the DIM pin, the light intensity can be controlled).

M12 MALE CONNECTOR – OUTPUT				
Contact arrangement	Number	Color Contact	Designation	Signal
	1	Brown	+24V	Power supply DC
	2	White	Not used	Not used
	3	Blue	GND	Common ground
	4	Black	Analog Intensity Control - DIM	0 – 24V (or 0-5V) look at the graph below Consumption: 0,6mA@24V Rise time: 8 μs / Fall time: 12 μs Response time: 16 μs
	5	Grey	Not used	Not used



### DIM behavior

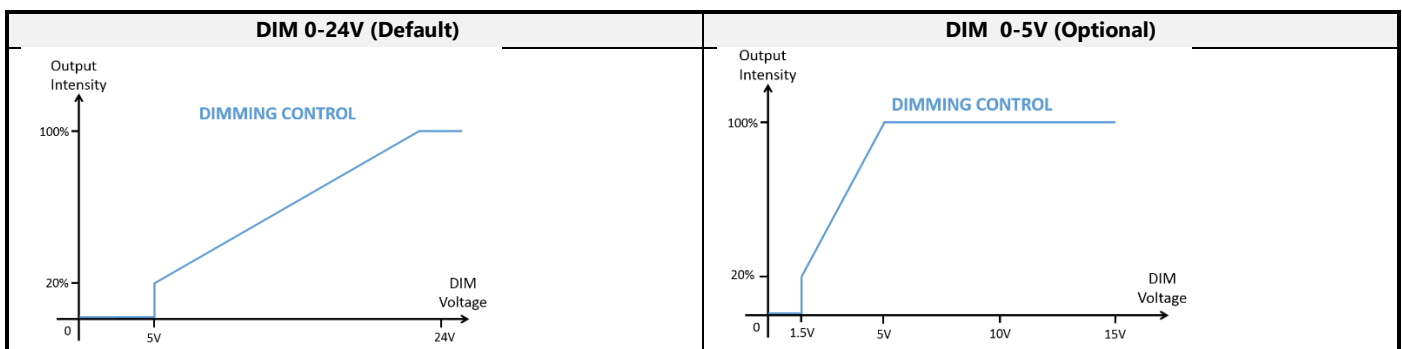

Optical considerations



Illuminance for white version

Ideal working distance for EFFI-SPOT is from 5 cm to 50 cm (for higher working distance we recommend to use EFFI-SHARP).

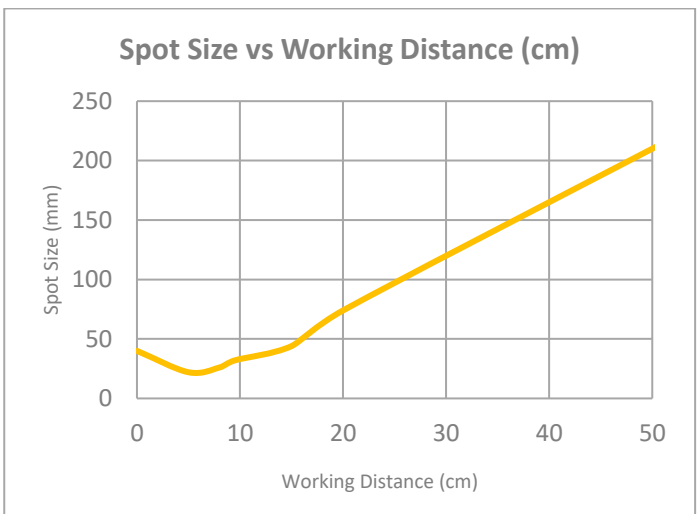
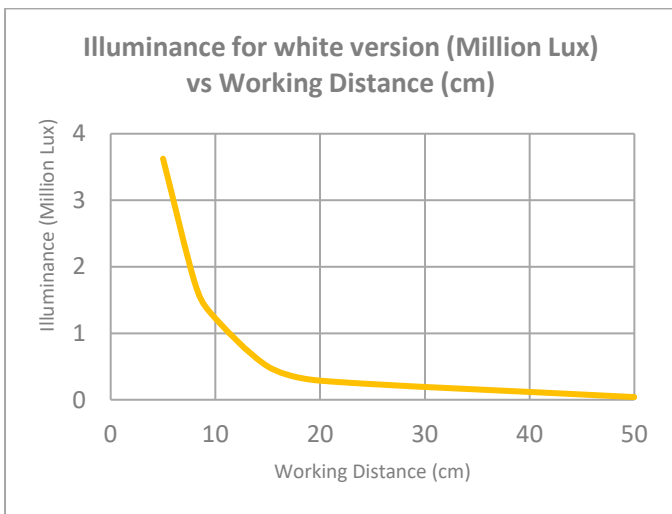
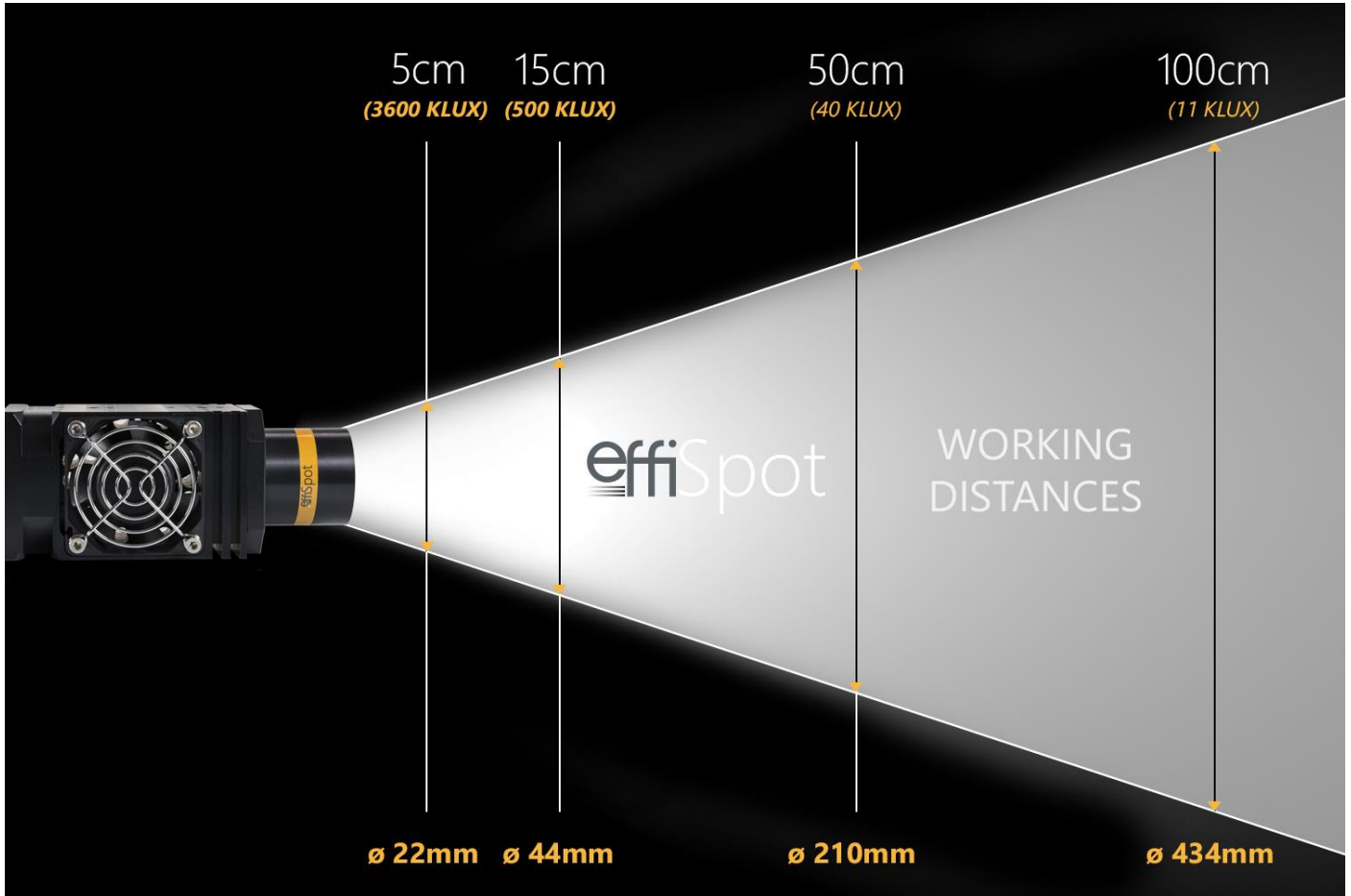

Mechanical consideration (Dimensions in mm)

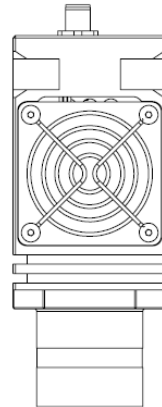
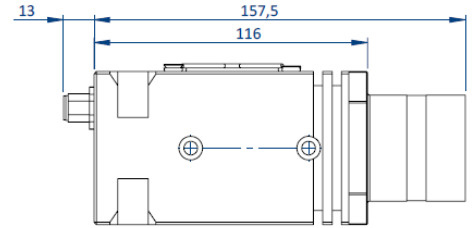
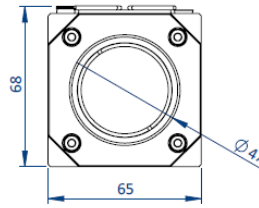
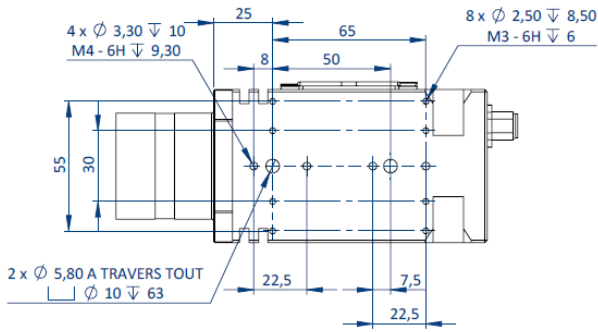

Do not cover the ventilation holes

## Accessories (to purchase separately)





### Mounting

To attach the EFFI-SPOT you can find:

- 8 M3x6 screw holes on one side
- 2 through holes with a diameter of 5,80 mm (suitable for M5)
- 2 M4x10 on each side (red circles)

→ Compatible with **EFFM-1-0009** & **EFFM-1-0027**

Picture	Mounting	Reference
	"Elcom" ball	EFFM-1-0009
	Adapter "tripod"	EFFM-1-0027

### Power supply



Reference	Features
EFFI-PWR-100W-24V-102-XX	1 output - M12, 50W / 24V - 2A XX : Type of power outlet (UK, EU, US, ...)
EFFI-PWR-200W-24V-302-XX	3 outputs - M12, 200W / 24V - 8A XX : Type of power outlet (UK, EU, US, ...)

### Cable



Connector	Length	Reference
M12 - Female 5 pins	2 m	EFFC-CAB-M12-F-5-D-L2
	5 m	EFFC-CAB-M12-F-5-D-L5
	10 m	EFFC-CAB-M12-F-5-D-L10
M12 - Female Male 5 pins (to be used with EFFI-PWR)	2 m	EFFC-CAB-M12-FM-5-DD-L2
	5 m	EFFC-CAB-M12-FM-5-DD-L5
	10 m	EFFC-CAB-M12-FM-5-DD-L10