

Piranha4 Cameras

Color 2k and 4k Trilinear and Quadlinear CMOS

sensors | **cameras** | frame grabbers | processors | software | vision solutions

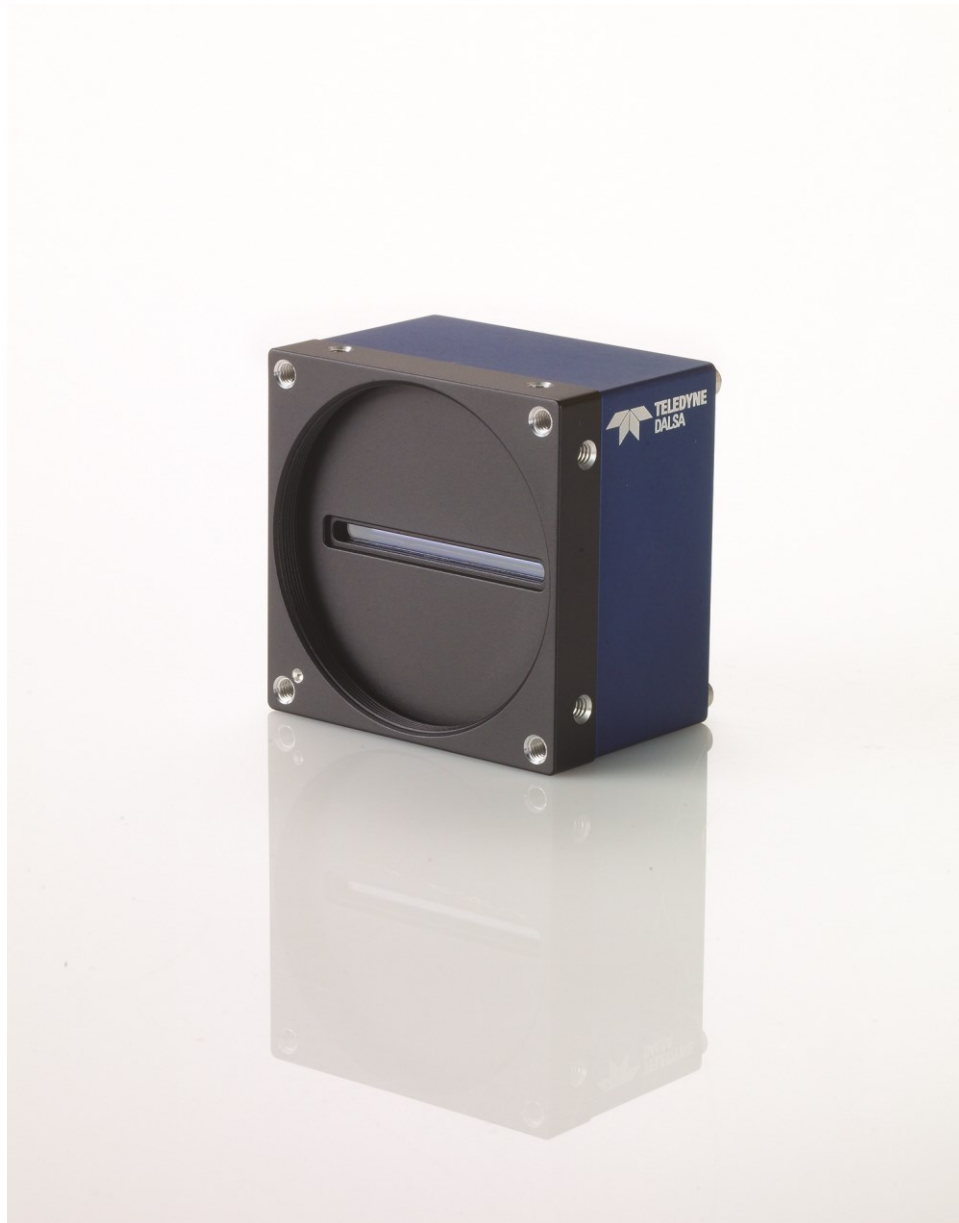

03-032-20180-07
www.teledynedalsa.com



Part of the Teledyne Imaging Group

Notice

© 2012-2021 Teledyne Digital Imaging, Inc.

All information provided in this manual is believed to be accurate and reliable. No responsibility is assumed by Teledyne DALSA for its use. Teledyne DALSA reserves the right to make changes to this information without notice. Reproduction of this manual in whole or in part, by any means, is prohibited without prior permission having been obtained from Teledyne DALSA.

Microsoft and Windows are registered trademarks of Microsoft Corporation in the United States and other countries. Windows, Windows 7, Windows 8 and Windows 10 are trademarks of Microsoft Corporation.

All other trademarks or intellectual property mentioned herein belong to their respective owners.

Document date: October 1, 2021

Document number: 03-032-20180-07

About Teledyne DALSA

Teledyne DALSA, a business unit of Teledyne Digital Imaging Inc., is an international high-performance semiconductor and electronics company that designs, develops, manufactures, and markets digital imaging products and solutions, in addition to providing wafer foundry services.

Teledyne DALSA Digital Imaging offers the widest range of machine vision components in the world. From industry-leading image sensors through powerful and sophisticated cameras, frame grabbers, vision processors and software to easy-to-use vision appliances and custom vision modules.

This document does not contain information whose export/transfer/disclosure is restricted by the Canadian Export Control regulation.

Contents

System Precautions	6
Precautions.....	6
Electrostatic discharge and the CMOS sensor.....	6
1. The Piranha4 Color Camera	7
Camera Highlights	7
Camera Performance Specifications	8
Flash memory size.....	10
Certifications	10
Supported Industry Standards.....	11
Sensor Responsivity and Design	11
Responsivity	11
Spatial correction and trilinear sensor design.....	16
Parallax correction.....	20
Camera direction.....	21
Mechanicals	22
Camera mounting and heat sink considerations	28
Filters	28
2. Quick, Simple Steps to Acquire an Image	29
3. Software and Hardware Setup	30
Recommended system requirements.....	30
Setup Steps: Overview.....	30
1. Install and configure frame grabber and software.....	30
2. Connect Camera Link and power cables.....	30
3. Establish communicating with the camera.....	30
4. Operate the camera.....	30
Step 1. Install and Configure the Frame Grabber and Software.....	31
Install frame grabber.....	31
Install Sapera LT and CamExpert GUI.....	31
Step 2. Connect Data, Trigger, and Power Cables.....	32
Data connector: Camera Link	33
Camera link bit definitions	34
Camera Timing	34
Camera Link cable quality and length	45
Input signals, Camera Link.....	45
Output signals, Camera Link clocking signals	46
Power connector	46
LEDs	47
Step 3. Establish Communication with the Camera.....	47
Power on the camera.....	47
Connect to the frame grabber	47
Connect to the camera	47
Check LED status	47

Software interface	48
Using Sopera CamExpert with Piranha4 Cameras	48
CamExpert panes	49
Review a test image	51
4. Camera Operation	52
Factory Settings	52
Check Camera and Sensor Information	52
Verify Temperature and Voltage	53
Saving and Restoring Camera Settings	54
Camera Link Configuration	56
Trigger Modes	56
Exposure Controls	56
Exposure Modes in Detail	58
Color exposure time guidelines	60
Set Line Rate	61
Set Exposure Time	68
Control Gain and Black Level	68
Set Image Size	69
Set Baud Rate	69
Pixel Format	70
Binning	70
Camera Direction Control	71
Pixel Readout Direction (Mirroring Mode)	71
Resetting the Camera	71
Calibrating the Camera	72
Appendix A: GenICam Commands	77
Camera Information Category	77
Camera information feature descriptions	78
Camera configuration selection dialog	81
Camera power-up configuration	81
User set configuration management	81
Camera Control Category	82
Camera control feature descriptions	83
Independent Exposure Control	86
Digital I/O control feature descriptions	88
Flat Field Category	89
Flat field control feature description	89
Region of Interest (ROI)	91
Image Format Control Category	91
Image format control feature description	93
Area of Interest (AOI) Setup	94
Instructions on using the camera scan direction to control camera parameters	97
Transport Layer Control Category	100
Transport Layer feature descriptions	101
Acquisition and Transfer Control Category	102
Acquisition and Transfer Control feature descriptions	102
Serial Port Control Category	103

Serial Port control feature descriptions	104
File Access Control Category	105
File Access Control feature descriptions.....	106
File Access via the CamExpert tool.....	108
Download a list of camera parameters.....	109
Appendix B: ASCII Commands	111
Port configuration.....	112
Commands	113
Appendix C: Quick Setup and Image Acquisition	126
Appendix D: The Sensor Window	129
Cleaning and protecting against dust, oil, and scratches	129
Cleaning the sensor window	130
Appendix E. Color Deca and Full Mode Acquisition	131
Overview	131
Supported Sopera LT	131
Programming Deca Mode.....	131
Programming Full Mode.....	134
Appendix F: Camera, Frame Grabber Communication	136
Setting up communication between the camera and the frame grabber	136
Appendix C: Error and Warning Messages	139
BiST: Built in Self-Test.....	139
Declarations of Conformity.....	141
FCC Statement of Conformance	141
EU and UKCA Declaration of Conformity	141
Revision History	142
Contact Information.....	143
Sales Information.....	143
Technical Support.....	143

System Precautions

Precautions

Read these precautions and this manual carefully before using the camera.

Confirm that the camera's packaging is undamaged before opening it. If the packaging is damaged please contact the relevant logistics personnel.

Do not open the housing of the camera. The warranty is voided if the housing is opened.

Keep the camera housing temperature in a range of 0 °C to +65 °C during operation.

Do not operate the camera in the vicinity of strong electromagnetic fields. In addition, avoid electrostatic charging, violent vibration, and excess moisture.

To clean the device, avoid electrostatic charging by using a dry, clean absorbent cotton cloth dampened with a small quantity of pure alcohol. Do **not** use methylated alcohol. To clean the surface of the camera housing, use a soft, dry cloth. To remove severe stains use a soft cloth dampened with a small quantity of neutral detergent and then wipe dry. Do not use volatile solvents such as benzene and thinners, as they can damage the surface finish. Further cleaning instructions are below.

Though this camera supports hot plugging, it is recommended that you power down and disconnect power to the camera before you add or replace system components.

Electrostatic discharge and the CMOS sensor

Image sensors and the camera bodies housing are susceptible to damage from electrostatic discharge (ESD). Electrostatic charge introduced to the sensor window surface can induce charge buildup on the underside of the window that cannot be readily dissipated by the dry nitrogen gas in the sensor package cavity. The charge normally dissipates within 24 hours and the sensor returns to normal operation.

Additional information on cleaning the sensor window and protecting it against dust, oil, blemishes, and scratches can be found here: [Appendix D: The Sensor Window](#).

1. The Piranha4 Color Camera

Camera Highlights

Based on Teledyne DALSA's unique CMOS color line scan sensor architecture, the Piranha4 2k and 4k Trilinear and Quadlinear color cameras provide outstanding signal-to-noise performance for high speed imaging. The Piranha4 4k model has 4k resolution with a 10 μm \times 10 μm pixel size for optimized optical design. The 2k model has 2k resolution with a 14 μm \times 14 μm pixel size. The cameras deliver a maximum line rate of 70 kHz.

Precise sensor alignment simplifies multiple camera calibration at the system level. GenICam™ or ASCII command-compliant interfaces make the camera easier to setup, control, and integrate. Programmable features include exposure control, flat field correction, and gain settings. The Piranha4 camera is ideal for the inspection of printing, printed circuit board, solar cell, film, and large format webs.

Key Features

- CMOS color line scan
- 2k or 4k pixel resolution
- Line rates up to 70 kHz
- Exposure control
- 100x antiblooming
- RGB or RGB plus mono outputs
- Camera Link interface
- GenICam or ASCII command-compliant interfaces

Programmability

- Save up to eight sets of correction coefficients
- Adjustable gain and offset
- White balance and color correction
- Lens and shading correction with defocusing capability
- Test pattern and diagnostics
- Multi-AOI output allows faster line rates

Applications

- Printing inspection
- High performance document scanning
- Electronics
- Film inspection
- High throughput applications

Models

The camera is available in the following configurations:

Table 1: Camera Models Overview

Model Number	Description
P4-CC-02K04T-00-R	2k resolution, 40 kHz line rate, 14.08 μm x 14.08 μm pixel size, trilinear
P4-CC-02K07T-00-R	2k resolution, 70 kHz line rate, 14.08 μm x 14.08 μm pixel size, trilinear
P4-CC-02K07Q-00-R	2k resolution, 70 kHz line rate, 14.08 μm x 14.08 μm pixel size, quadlinear
P4-CC-04K04T-00-R	4k resolution, 40 kHz line rate, 10.56 μm x 10.56 μm pixel size, trilinear
P4-CC-04K07T-00-R	4k resolution, 70 kHz line rate, 10.56 μm x 10.56 μm pixel size, trilinear
P4-CC-02K04T-01-R	2k resolution, 40 kHz line rate, 14.08 μm x 14.08 μm pixel size, trilinear, small body
P4-CC-04K04T-01-R	4k resolution, 40 kHz line rate, 10.56 μm x 10.56 μm pixel size, trilinear, small body

Table 2: Software

Software	Product Number / Version Number
Camera firmware	Embedded within camera
GenICam™ support (XML camera description file)	Embedded within camera
Sapera LT, including CamExpert GUI application and GenICam for Camera Link imaging driver	Version 7.2 or later

Camera Performance Specifications

Table 3: Camera Performance Specifications

Specifications	Performance	
Imager Format	CMOS trilinear or quadlinear color line scan	
Resolution	2048 x 3 and 2048 x 4, or 4096 x 3 pixel line	
Pixel Size	14.08 μm x 14.08 μm (2k) and 10.56 μm x 10.56 μm (4k)	
Full Well Capacity	20 ke- @ minimum gain of 1x	
Line Rate	0 kHz minimum to 70 kHz maximum	
Exposure Time	7 μs minimum to 3,000 μs maximum	
Bit Depth	8, 10, and 12 bits	
Connectors and Mechanicals		
Control & Data Interface	2 SDR26 Camera Link connectors used to transmit Base, Medium, Full, or Deca configurations	
Power Connector	Hirose 6-pin circular	
Power Supply	+ 12 V to + 24 V DC	
Maximum Current Draw	12 W (applied voltage at camera connector)	
Power Dissipation	Camera Models	Value
	P4-CC-02K04T-00-R	8 W
	P4-CC-02K07T-00-R	8 W
	P4-CC-02K07Q-00-R	8 W
	P4-CC-04K04T-00-R	12 W
	P4-CC-04K07T-00-R	12 W

	P4-CC-02K04T-01-R P4-CC-04K04T-01-R	6 W 9 W
Size & Mass	Camera Models	Measurements
	P4-CC-02K04T-00-R P4-CC-02K07T-00-R P4-CC-02K07Q-00-R P4-CC-04K04T-00-R P4-CC-04K07T-00-R P4-CC-02K04T-01-R P4-CC-04K04T-01-R	62 mm (W) x 62 mm (H) x 48 mm (D) < 340 g (without heat sinks) 62 mm (W) x 62 mm (H) x 37 mm (D) < 300 g (without heat sinks)
Operating Temperature	0 °C to 65 °C, front plate temperature	
Optical Interface		
Lens Mount	M58 x 0.75 F-mount adapter available	
Sensor to Camera Front Distance	12 mm	
Sensor Alignment (aligned to sides of camera)	Camera Models	Value
	P4-CC-02K04T-00-R P4-CC-02K07T-00-R P4-CC-02K07Q-00-R P4-CC-04K04T-00-R P4-CC-04K07T-00-R P4-CC-02K04T-01-R P4-CC-04K04T-01-R	Flatness Θ y (parallelism) x y z Θ z Flatness Θ y (parallelism) x y z Θ z
Compliance		
Regulatory Compliance	CE and RoHS, GenICam	

Table 4: P4-CC-02K Operating Ranges

Operating Ranges	Performance			
	Red	Green	Blue	Mono
Dynamic Range	61.8 dB	61.8 dB	61.8 dB	61.8 dB
Random Noise	3.36 DN** rms	3.36 DN rms	3.36 DN rms	3.36 DN rms
Responsivity	Refer to graph			
Gain	1x to 10x Nominal Range (not including individual RGB gains for white balance)			
DC Offset	< 11 DN	< 11 DN	< 11 DN	< 11 DN
PRNU	< 2% @50% Sat	< 2% @50% Sat	< 2% @50% Sat	< 2% @50% Sat
FPN	< 6.3 DN	< 6.3 DN	< 6.3 DN	< 6.3 DN
SEE	3.96 nJ / cm ²	4.39nJ / cm ²	6.80 nJ / cm ²	3.64 nJ / cm ²
NEE	3.2 pJ / cm ²	3.6 pJ / cm ²	5.6 pJ / cm ²	3.0 pJ / cm ²
Antiblooming	> 100 x Saturation			

Integral non-linearity	< 2% DN
------------------------	---------

Table 5: P4-CC-04K Operating Ranges

Operating Ranges	Performance		
	Red	Green	Blue
Dynamic Range	61.8 dB	61.8 dB	61.8 dB
Random Noise	3.25 DN** rms	3.25 DN rms	3.25 DN rms
Responsivity	Refer to graph		
Gain	1x to 10x Nominal Range (not including individual RGB gains for white balance)		
DC Offset	< 11 DN	< 11 DN	< 11 DN
PRNU	< 2% @50% Sat	< 2% @50% Sat	< 2% @50% Sat
FPN	< 6.3 DN	< 6.3 DN	< 6.3 DN
SEE	7.8 nJ / cm ²	9.6 nJ / cm ²	9.5 nJ / cm ²
NEE	6.3 pJ / cm ²	7.8 pJ / cm ²	7.7 pJ / cm ²
Antiblooming	> 100 x Saturation		
Integral non-linearity	< 2% DN		

**DN = digital number

Test Conditions:

- Values measured using 12-bit, 1x gain.
- 10 kHz line rate
- Light source: white LED
- No white balancing
- Front plate temperature: 45° C

Environmental Specifications	
Storage temperature range	-20 °C to +80 °C
Humidity (storage and operation)	15% to 85% relative, non-condensing
MTBF (mean time between failures)	>100,000 hours, typical field operation

Flash memory size

Camera	Flash Memory Size
All models	16 MByte

Certifications

Compliance
See the Declarations of Conformity section.
GenICam XML Description File, Superset of the GenICam™ Standard Features Naming Convention specification V1.5, Camera Link Serial Communication: GenICam™ Generic Control Protocol (GenCP V1.0)

Supported Industry Standards

GenICam™

Piranha4 cameras are GenICam compliant. They implement a superset of the GenICam™ Standard Features Naming Convention specification V1.5. This description takes the form of an XML device description file respecting the syntax defined by the GenApi module of the GenICam™ specification. The camera uses the GenICam™ Generic Control Protocol (GenCP V1.0) to communicate over the Camera Link serial port. For more information see www.genicam.org.

Sensor Responsivity and Design

Responsivity

The responsivity graph illustrates the sensor's response to different wavelengths of light (excluding lens and light source characteristics).

Note: The responsivity of a color camera will measure approximately 1/6th that of a similar monochrome camera model as a result of the effect the color filter has on the sensor and also due to the color camera not incorporating TDI Mode.

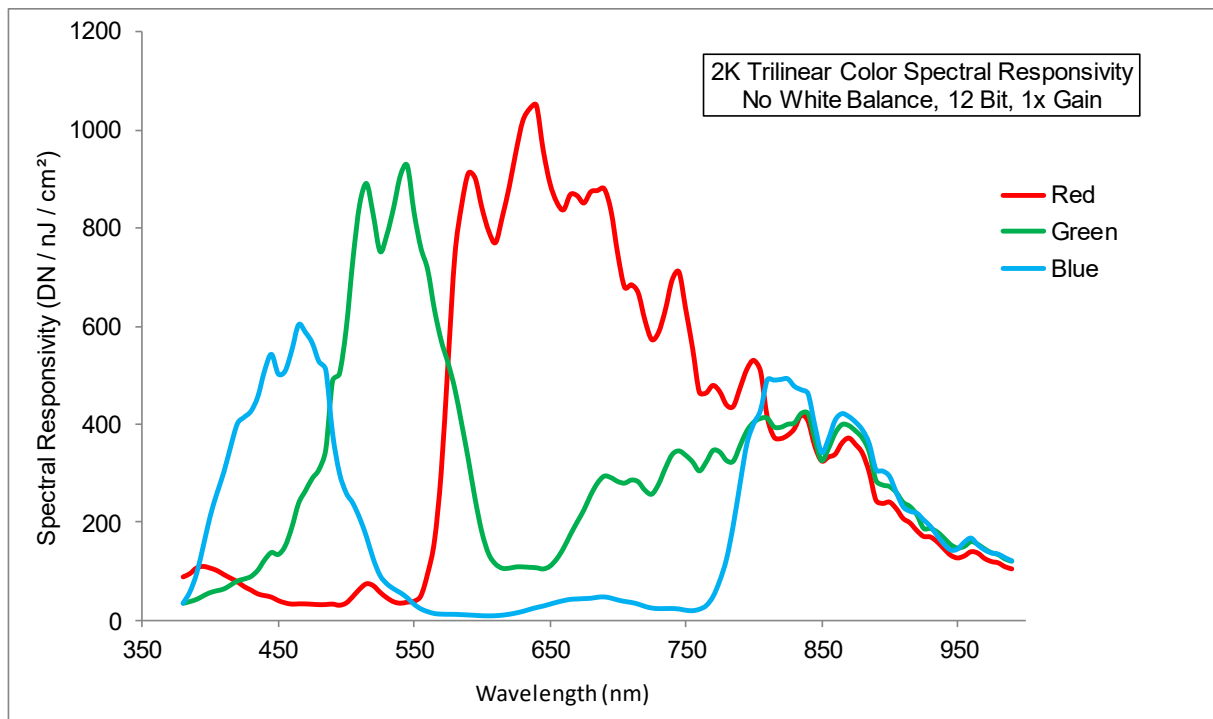

Figure 1: 2k Trilinear Spectral Responsivity

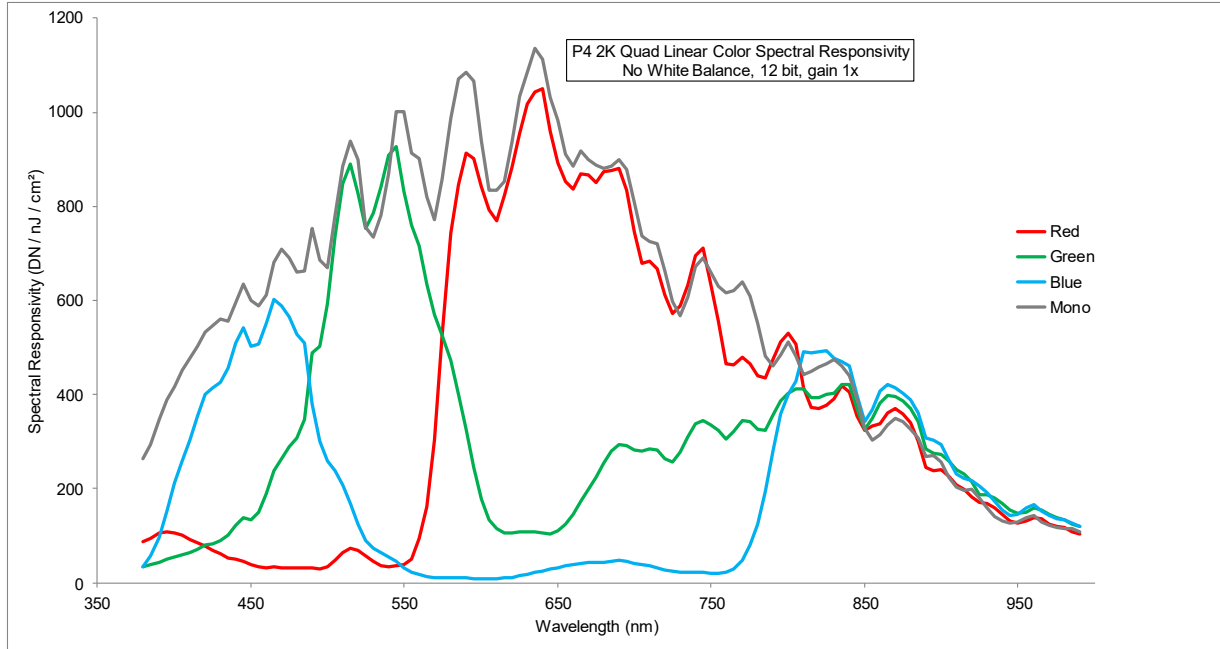

Figure 2: 2k Quadlinear Spectral Responsivity

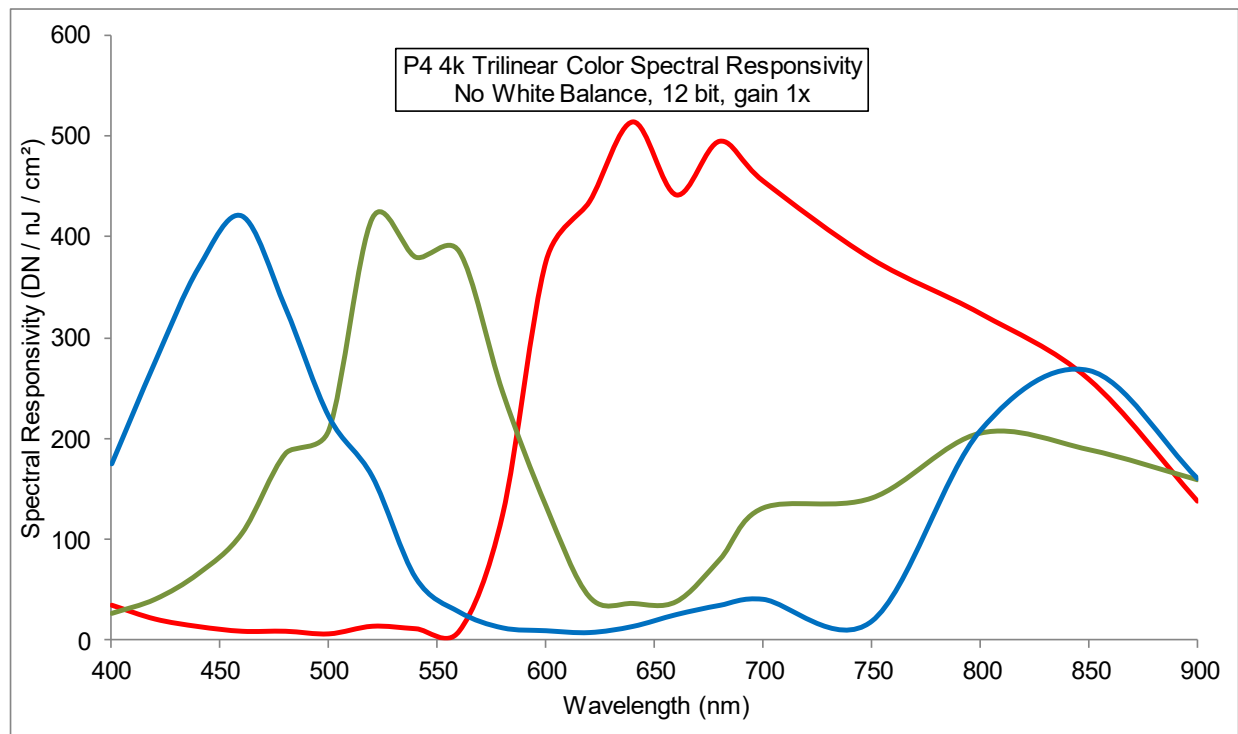

Figure 3: 4k Trilinear Spectral Responsivity

Filters

CMOS cameras are responsive to infrared (IR) wavelengths of light. Infrared light can be problematic with halogen light sources but is not an issue with white LED sources. When infrared light is present with

this camera color fidelity is reduced. To prevent infrared from distorting the images you scan, use an IR cut off filter such as a BG-38 on the lens.

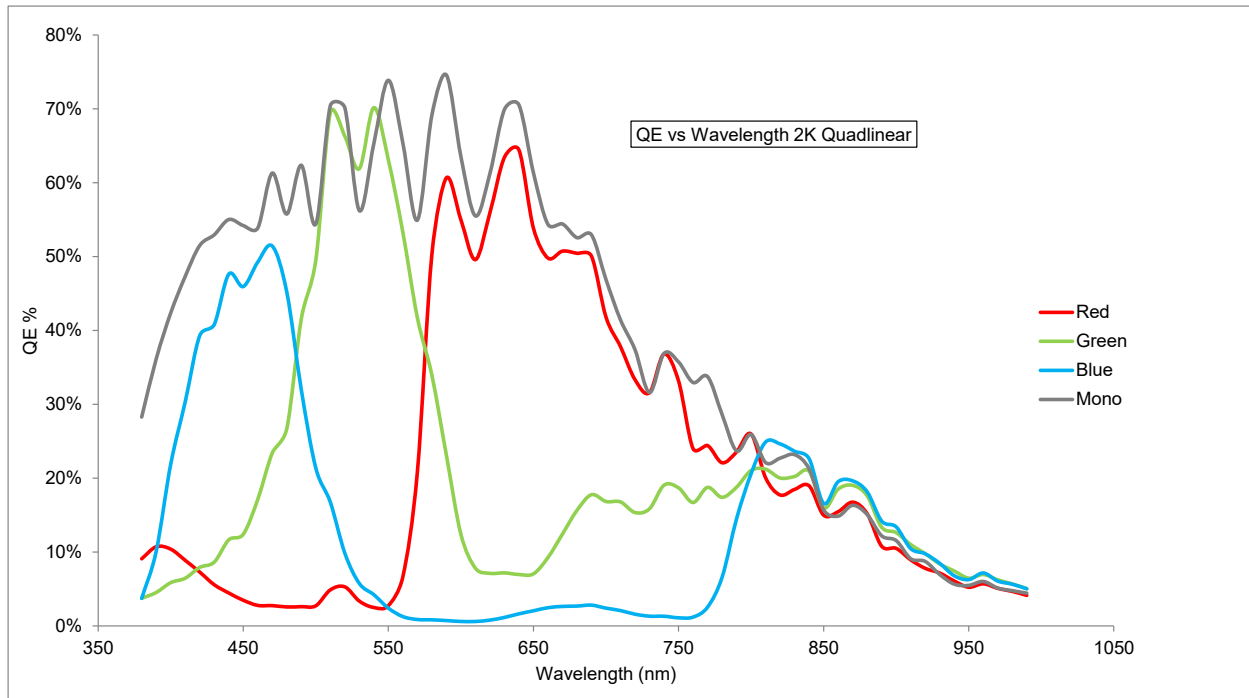

Figure 4: 2k Quadlinear QE Vs Wavelength

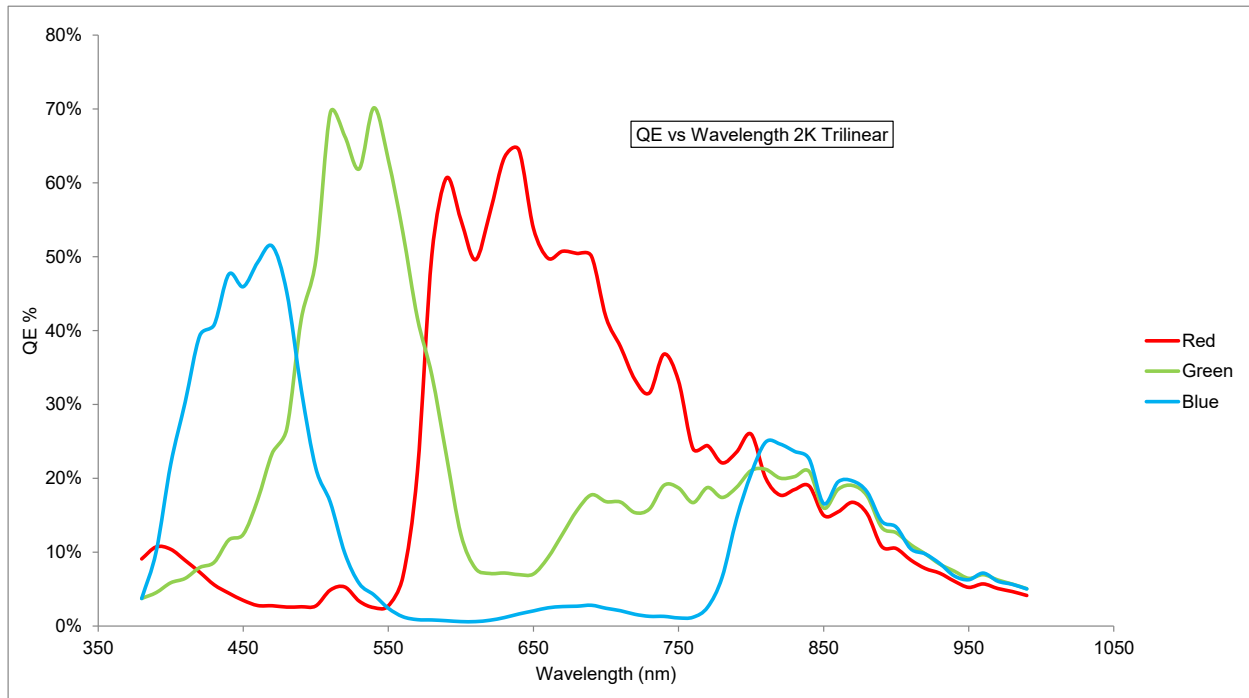

Figure 5: 2k Trilinear QE Vs Wavelength

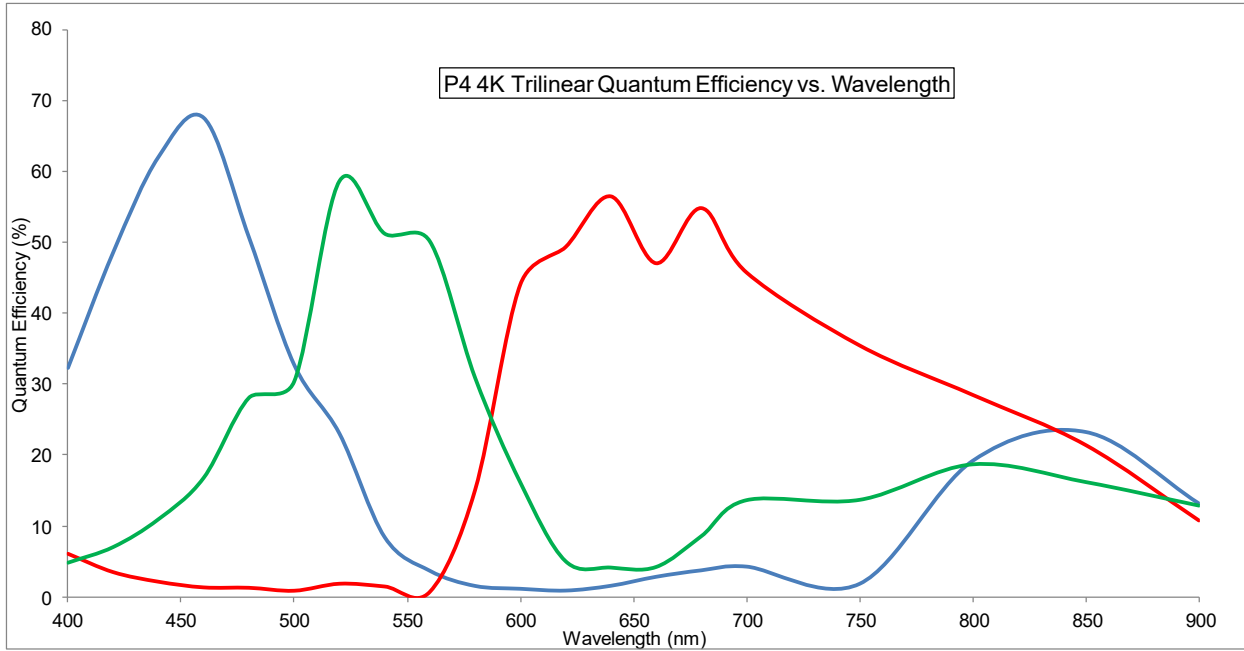

Figure 6: 4k Trilinear QE Vs Wavelength

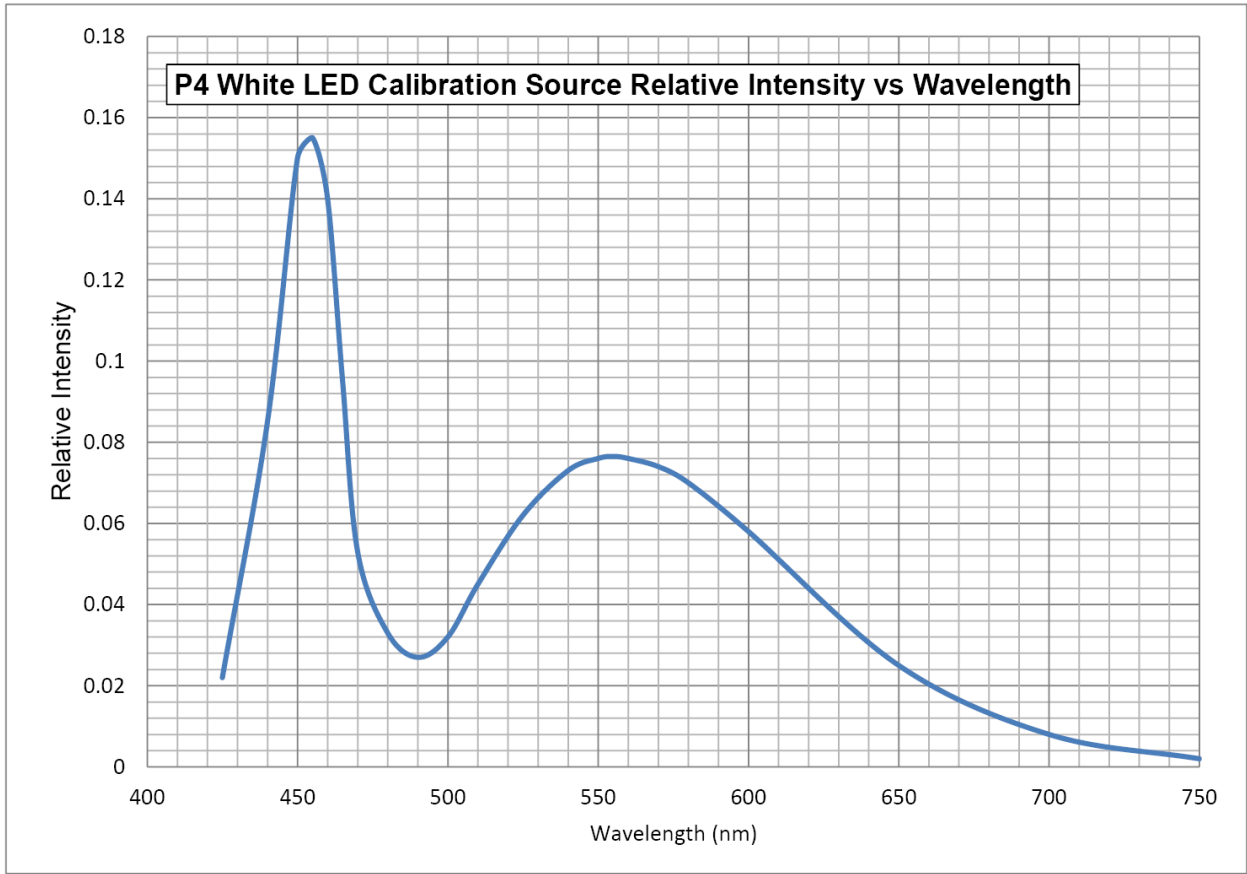

Figure 7: Calibration Source Relative Intensity vs. Wavelength

Spatial correction and trilinear sensor design

The P4-CC-04K07T-00-R camera uses a trilinear sensor where three separate 4K lines of pixels are used — one for red, the center for blue and the last for green.

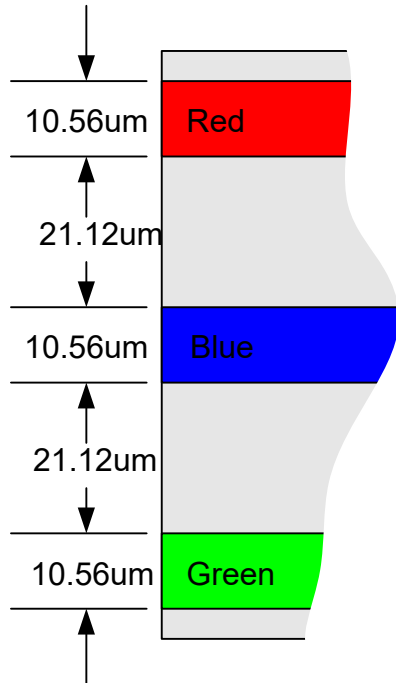

Figure 8: 4k Trilinear Sensor Line Spacing Diagram

The P4-CC-02K07T-00-R camera uses a trilinear sensor where three separate 2K lines of pixels are used — one for red, the center for blue and the last for green.

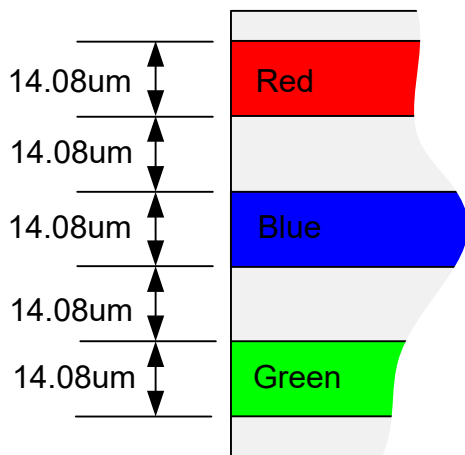

Figure 9: 2K Trilinear Sensor Line Spacing Diagram

The P4-CC-02K07Q-00-R camera uses a trilinear sensor where four separate 2K lines of pixels are used — one for red, the center for blue and the last for green.

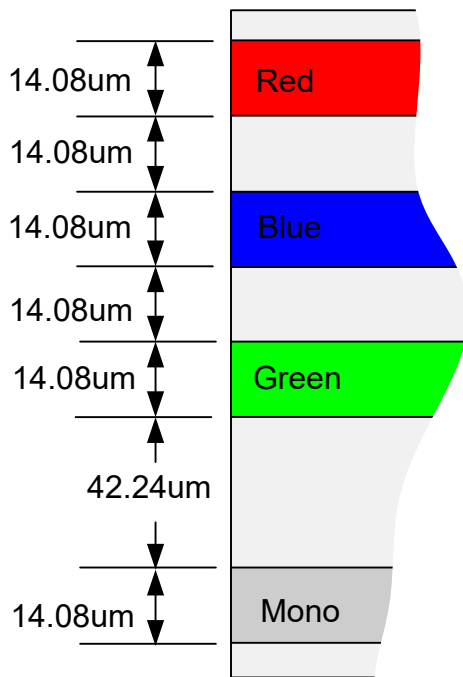

Figure 10: 2K Quadlinear Sensor Line Spacing Diagram

In the case of the 4k cameras, the three lines of pixels are separated by two lines of spacing and this line spacing is equal to 2x the sensor pixel size. In the case of the 2k cameras, only a single line of space separates the colored lines—with the exception of the monochrome line, which has three lines of spacing.

When the image passes the three lines of pixels, the red, blue and green components for the same image location are captured at a different time as dictated by the line spacing. The camera automatically corrects for the line spacing to ensure that the red, blue and green components of the image pixel are all aligned when output. However, this is only correct when the object pixel size is square; i.e., the distance moved by the object for one EXSYNC period is equal to the width of the object pixel. In some applications it may not be possible to achieve a 'square' object pixel as fine adjustment of the lens magnification and/or the distance moved for each EXSYNC period is not possible. This scenario may be especially apparent when trying to integrate the camera into an existing system.

When it is not possible to generate a square object pixel, color artefacts will occur in the scan direction and is particularly noticeable at sharp edge transitions. The size of the edge artefact is proportional to how far the pixel is from square. To correct for this, the camera has a feature, Line Spatial Correction (or three letter command ssa), which allows fine adjustment of the compensation mechanism the camera uses to correct for the line spacing.

The default setting for this feature is 3 (4k model) or 2 (2k model), which is set for square object pixels. The setting can be adjusted from 0 to 5 to compensate for rectangular pixels—whether they are too long or too short.

The following examples of image artefacts show black to white image transitions and the associated corrected image after applying a specific ssa setting.

Example 1. Target speed adjusted for square pixels



Line Spatial Correction = 3 (ssa = 3). This is the default condition.

Example 2. Target running slower than example 1, same EXSYNC (trigger) frequency

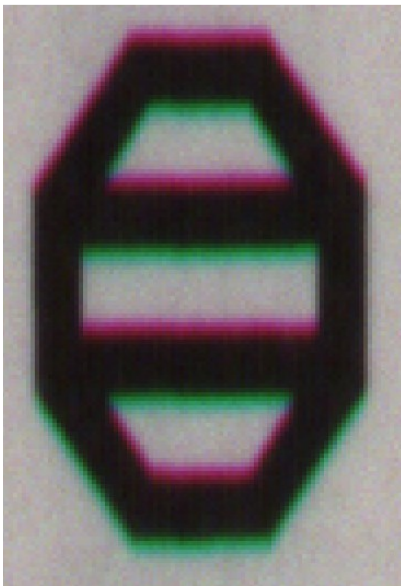

Line Spatial Correction = 3 (ssa = 3)

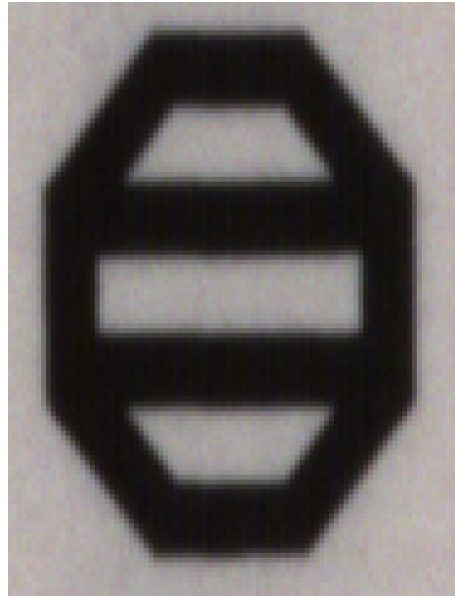

Line Spatial Correction = 4.3 (ssa = 4.3)

Example 3. Target running faster than example 1, same EXSYNC (trigger) frequency

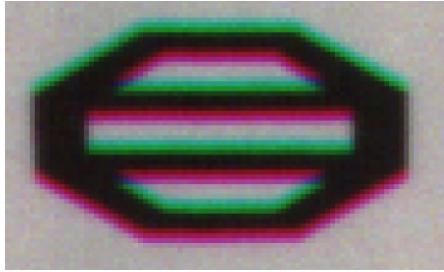

Line Spatial Correction = 3 (ssa = 3)

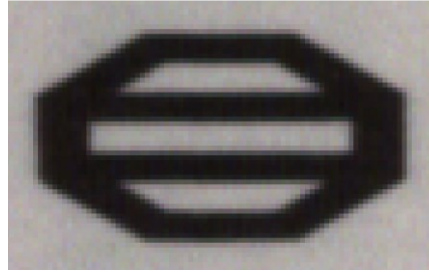

Line Spatial Correction = 1.73 (ssa = 1.73)

Example 4. Target running slower than EXSYNC

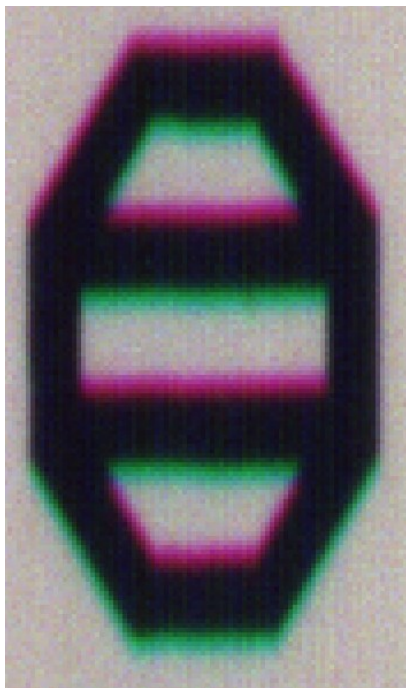

Line Spatial Correction = 3 (ssa = 3)



Line Spatial Correction = 1 (ssa = 1)

Example 5. Target running faster than EXSYNC

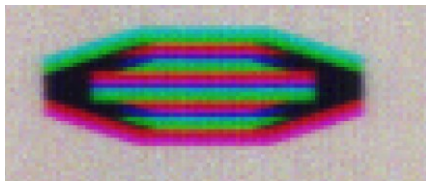

Line Spatial Correction = 3 (ssa = 3)



Line Spatial Correction = 5 (ssa = 5)

Parallax correction

When the camera is not perpendicular to the object surface the P4 color camera will exhibit color. The parallax distortion increases when imaging at steep angles relative to the camera's imaging plane. This is an optical effect caused by the line spacing of the three individual colors. This spacing results in a different magnification for each line at high angles. As shown in the figure below, there is color distortion at the extreme ends of the image but at the center of the image the color distortion does not show up.

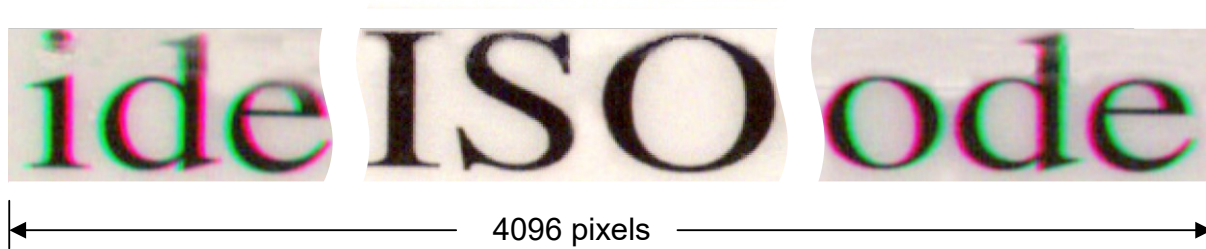

Figure 11: Image with Horizontal Color Alignment Issues

Using the P4 color camera's Parallax Correction feature, the optical magnification for each line is adjusted such that colors can be lined up at the extreme ends of the image without affecting the center. Using the feature Image Distortion Correction Mode ($shm = 1$) this feature can be turned on. Using the feature Image Distortion Correction Line Selector the user can select red and green to correct the distortion. Note. The red and green lines are adjusted to align with the center blue line. Image Distortion Parallax Correction Pixel Stretch (sha - Set horizontal alignment in float $f<value\ 0-3>$) is used to add the amount of correction needed to the image. The value entered here must be between 0 and 3 (decimal values are accepted).

Image Distortion Correction Mode	Off
Image Distortion Correction Algorithm	ParallaxCorrection
Image Distortion Correction Line Selector	Red
Image Distortion Parallax Correction Pixel Stretch	0

Figure 12: CamExpert Parallax Correction Controls

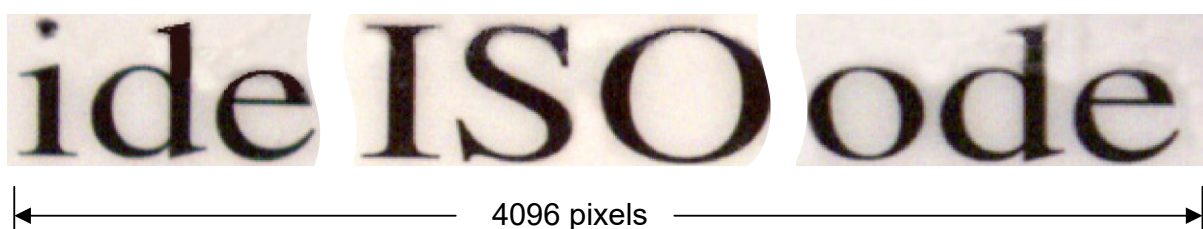

Figure 13: Figure 14 Corrected Image

The figure above is the same image corrected using the parallax correction. In this example the value of 3 was used to correct the image.

Camera direction

Selectable camera direction accommodates an object direction change on a web and allows you to mount the camera “upside down”.

Note: The example here assumes the use of a lens (which inverts the image).

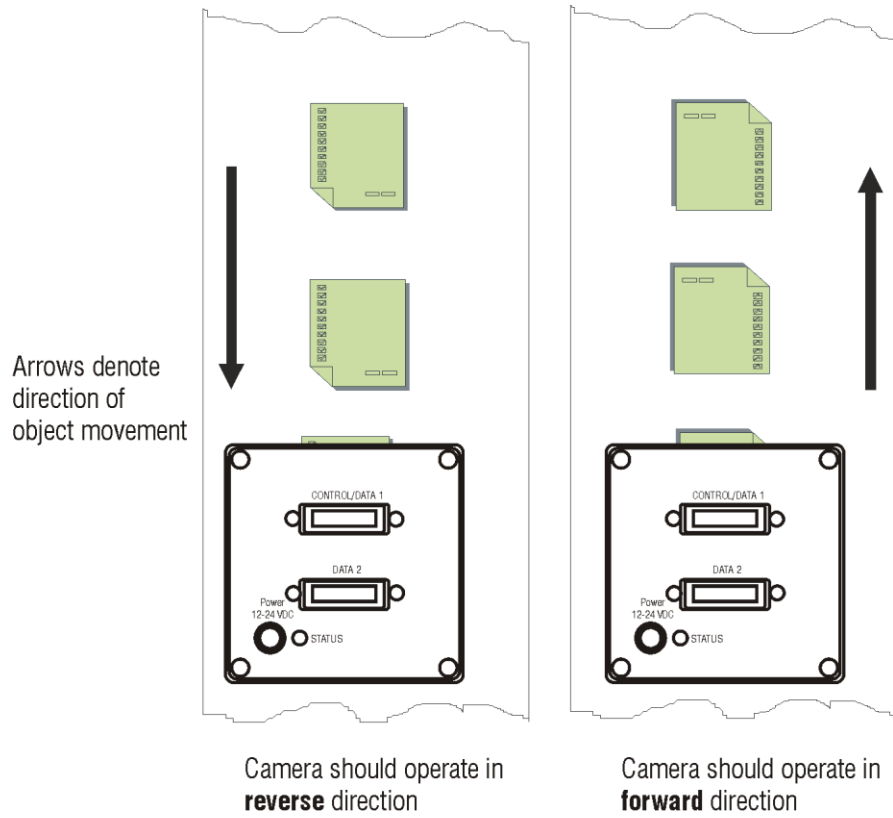

Figure 15: Object Movement and Camera Direction Example, with a Lens

Mechanicals

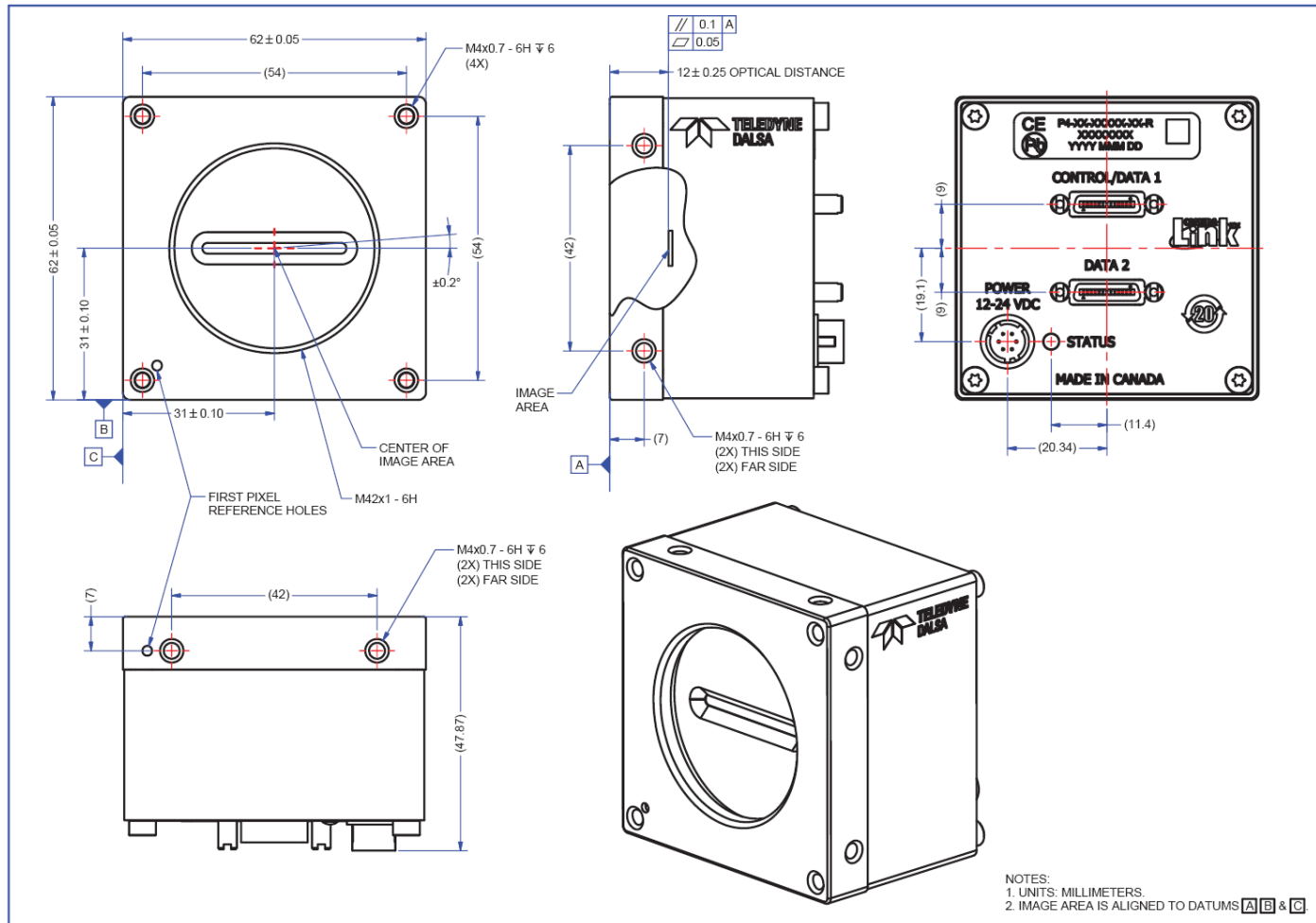

Figure 16: P4-CC-02K04T-00-R and P4-CC-02K07T-00-R Camera Mechanicals

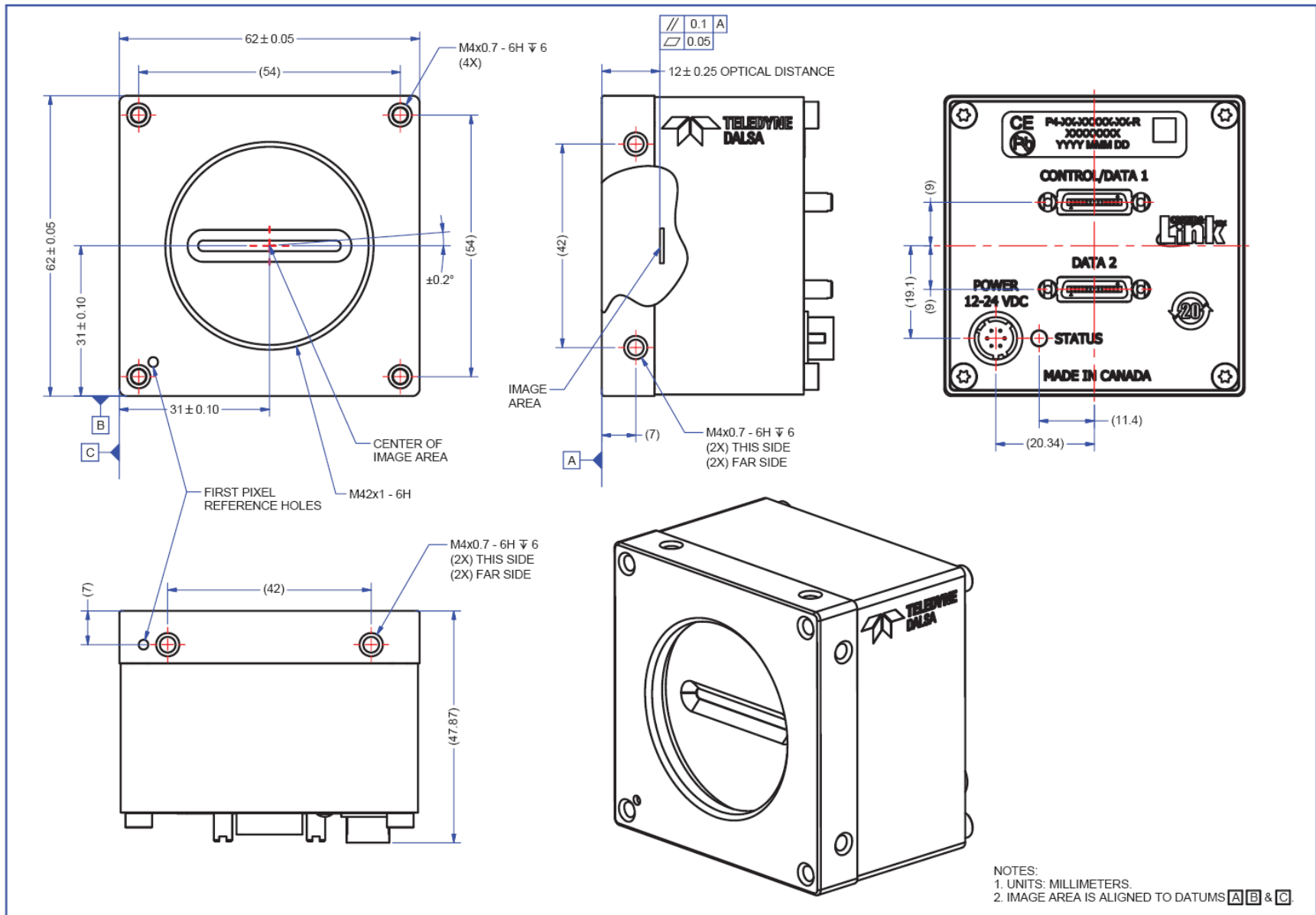
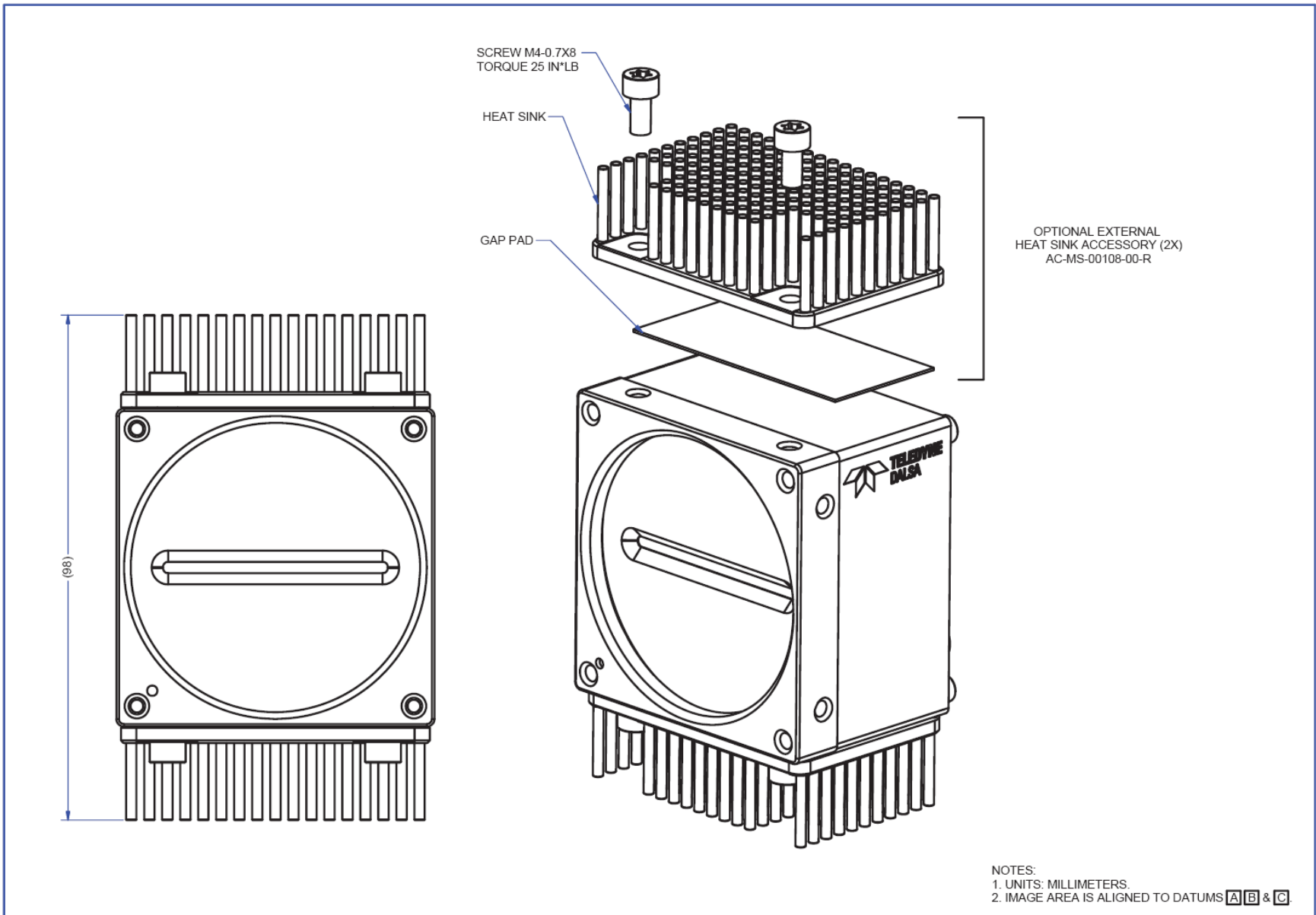

Figure 17: P4-CC-04K04T-00-R and P4-CC-04K07T-00-R Camera Mechanics (shown with optional heat sink below)



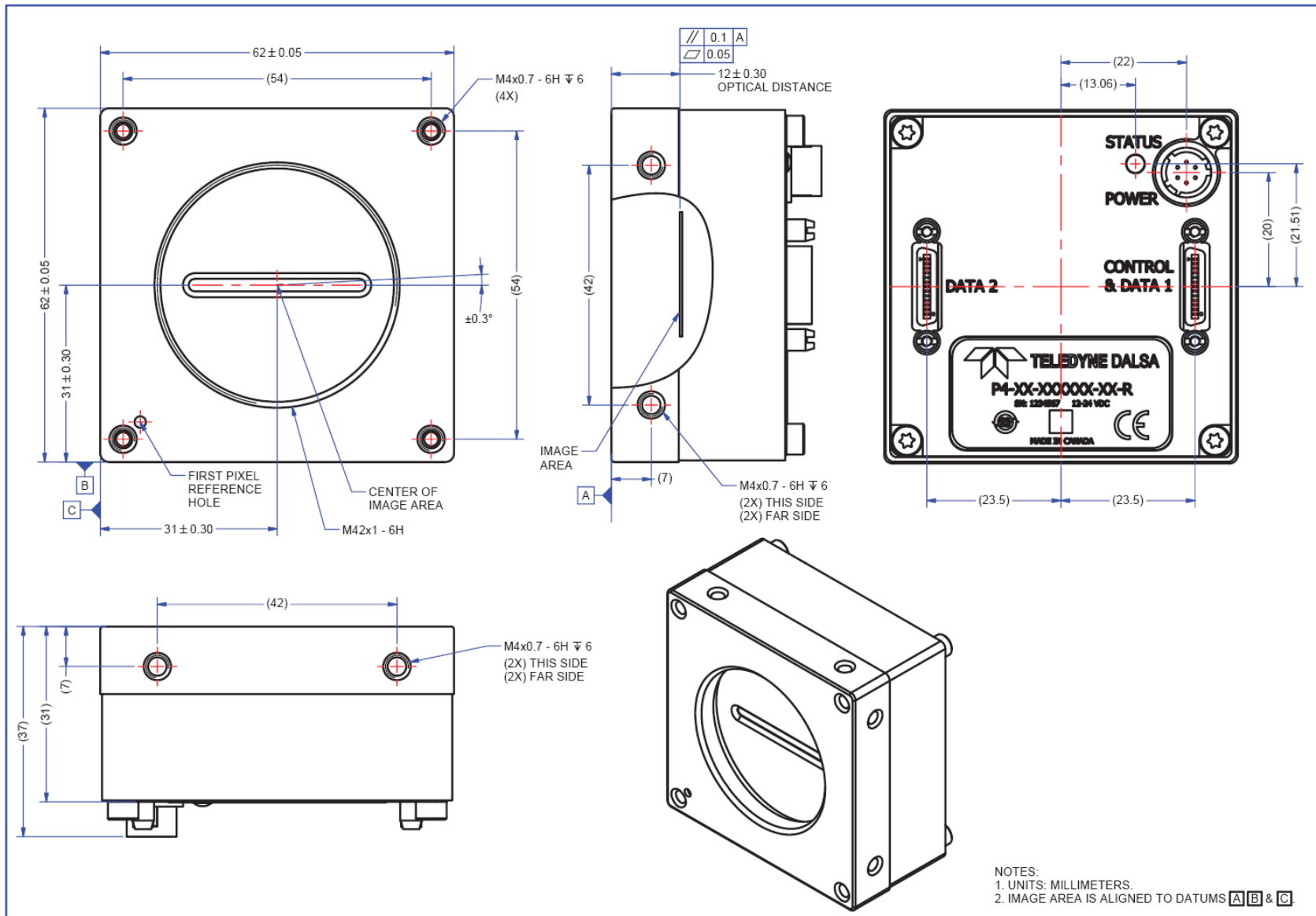

Figure 18: P4-CC-02K04T-01-R Small Body Camera Mechanical

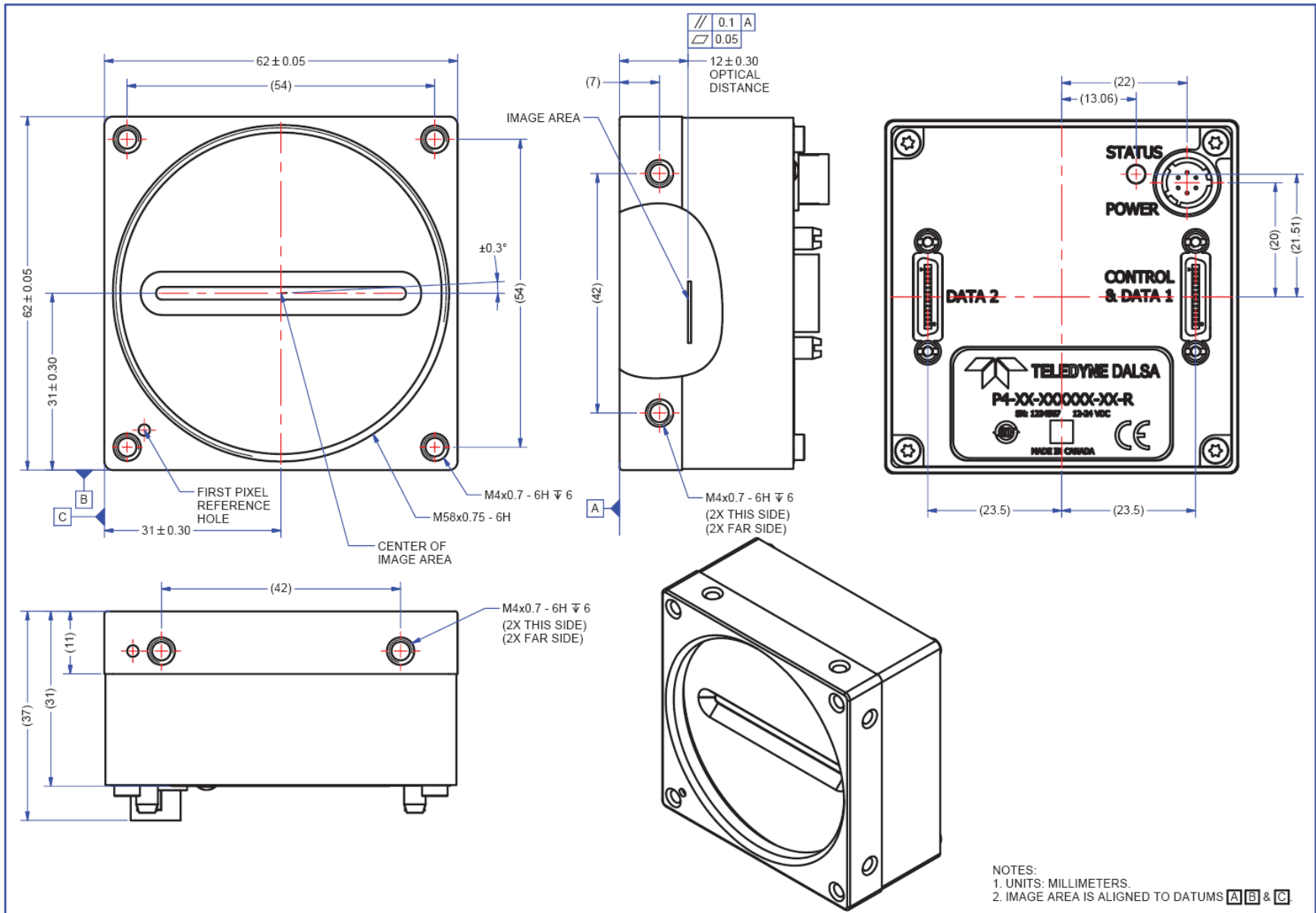

Figure 19: P4-CC-04K04T-01-R Small Body Camera Mechanical



Figure 20: Nikon M58 to F-Mount Adapter

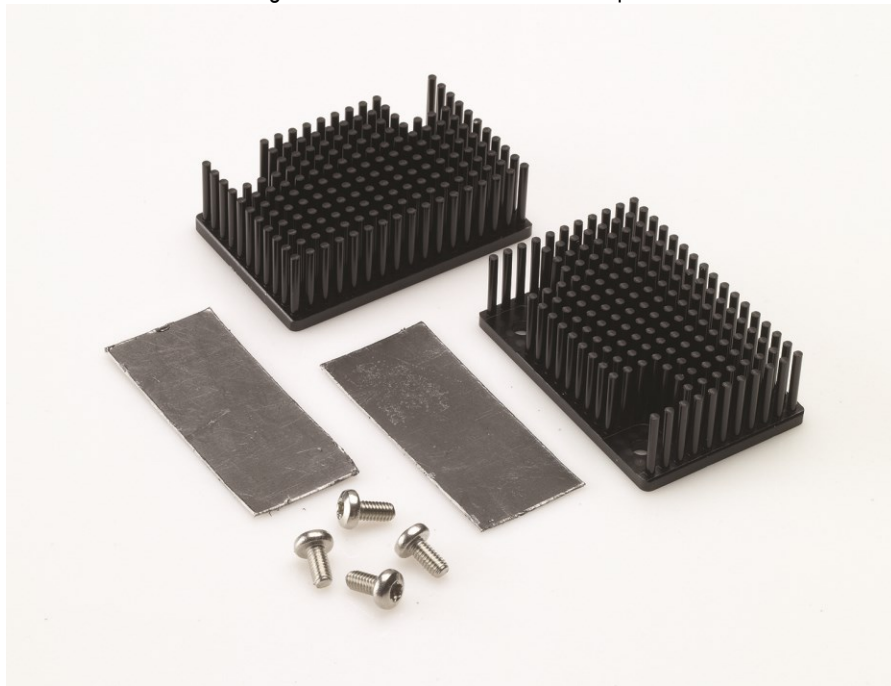

Figure 21: Piranha4 Heat Sink Accessories Kit

Optional Lens Mount and Heat Sink Accessories

Part No.	Description
AC-LN-00002	M58 to F-mount adapter, heavy duty, 12mm BFD, for 4K model
AC-LC-00001	M42x1 to C-mount adapter, 12mm BFD, for 2K model
AC-LA-00115	M42x1 to F-mount adapter, heavy duty, 12mm BFD, for 2K model
AC-MS-00108	Heat sink for 2k and 4k models

Camera mounting and heat sink considerations

Up to two optional heat sinks can be installed on the camera. As illustrated, they are ideally positioned to allow close spacing of the cameras. These heat sinks are designed to provide adequate convection cooling when not obstructed by enclosures or mounting assemblies.

Teledyne DALSA recognises that each customer's application can be unique. In consideration, the P4 camera heat sinks have been designed in such a way that they can be repositioned on the different faces of the camera or removed entirely, depending on the mounting configuration and its heat sinking potential.

Repositioning or removal of the heat sinks must be performed with care in order to avoid temperature issues. The camera has the ability to measure its internal temperature. Use this feature to record the internal temperature of the camera when it is mounted in your system and operating under the worst case conditions. The camera will stop outputting data if its internal temperature reaches 80 °C.

Filters

CMOS cameras are responsive to infrared (IR) wavelengths of light. Infrared light can be problematic with halogen light sources but is not an issue with white LED sources. When infrared light is present with this camera color fidelity is reduced. To prevent infrared from distorting the images you scan, use an IR cut off filter such as a BG-38 on the lens.

2. Quick, Simple Steps to Acquire an Image

For users who are familiar with Camera Link cameras, have a basic understanding of their imaging requirements, and who are primarily interested in evaluating the Piranha4 camera, an overview of the steps required to get this camera operational and acquiring images quickly can be found in [Appendix C: Quick Setup and Image Acquisition](#).

3. Software and Hardware Setup

Recommended system requirements

To achieve best system performance, the following minimum requirements are recommended:

- High bandwidth frame grabber, e.g. Xcelera-CL PX8 Full Camera Link frame grabber (Part # OR-X8CO-XPFO0): www.teledynedalsa.com/imaging/products/fg/OR-X8CO-XPFO0/.
- Operating systems: Windows XP / Vista / 7, 32 / 64-bit.

Setup Steps: Overview

Take the following steps in order to setup and run your camera system. They are described briefly below and in more detail in the sections that follow.

1. Install and configure frame grabber and software

We recommend the Xcelera-CL PX8 Full frame grabber or equivalent, described in detail on the teledynedalsa.com site [here](#). If your host computer does not have a PX8 full Camera Link frame grabber then you will need to install one. Follow the manufacturer's installation instructions.

A GenCP (Generic Control Protocol) compliant XML device description file is embedded within the camera firmware allowing GenCP-compliant applications to know the camera's capabilities immediately after connection. Installing SaperaLT gives you access to the CamExpert GUI, a tool that supports GenCP-compliant devices.

2. Connect Camera Link and power cables

- Connect the Camera Link cables from the camera to the computer.
- Connect a power cable from the camera to a +12 VDC to +24 VDC power supply.

3. Establish communicating with the camera

Start the GUI and establish communication with the camera.

ASCII Commands

As an alternative to the CamExpert (or equivalent) GUI, you can communicate with this camera using ASCII-based commands. A complete list of the commands can be found here, [Appendix B: ASCII Commands](#).

4. Operate the camera

At this point you will be ready to start operating the camera in order to acquire images, set camera functions, and save settings.

Step 1. Install and Configure the Frame Grabber and Software

Install frame grabber

Install a Full configuration Camera Link frame grabber according to the manufacturer's description.

We recommend the Xcelera-CL PX8 frame grabber or equivalent, described in detail on the teledynedalsa.com site [here](#).

Install Sopera LT and CamExpert GUI

Communicate with the camera using a Camera Link-compliant interface. We recommend you use CamExpert. CamExpert is the camera interfacing tool supported by the Sopera library and comes bundled with SoperaLT. Using CamExpert is the simplest and quickest way to send commands to and receive information from the camera.

Camera Link Environment

These cameras implement the Camera link specification, which defines the device capabilities. The Camera link XML device description file is embedded within the camera firmware allowing Camera link-compliant applications to recognize the cameras' capabilities immediately after connection.

Step 2. Connect Data, Trigger, and Power Cables

Note: the use of cables types and lengths other than those specified may result in increased emission or decreased immunity and performance of the camera.



Figure 22: Input and Output, trigger, and Power Connectors



WARNING! Grounding Instructions

Static electricity can damage electronic components. It's critical that you discharge any static electrical charge by touching a grounded surface, such as the metal computer chassis, before handling the camera hardware.

Data connector: Camera Link

The camera uses two Camera Link SDR26 cables transmitting the Camera Link Base, Medium, Full, or Deca configuration. The figure below shows the SDR26 Camera Link Connector and the tables that follow list the Camera Link configurations.

For detailed information on Camera Link please refer to the Camera Link Road Map available from the [Knowledge Center](#) on the Teledyne DALSA Web site.

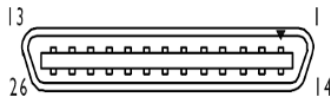

Figure 23. SDR26 Camera Link Connector

Data 2			Control / Data 1		
Camera Connector	Right Angle Frame Grabber Connector	Channel Link Signal	Camera Connector	Right Angle Frame Grabber Connector	Channel Link Signal
1	1	inner shield	1	1	inner shield
14	14	inner shield	14	14	inner shield
2	25	Y0-	2	25	X0-
15	12	Y0+	15	12	X0+
3	24	Y1-	3	24	X1-
16	11	Y1+	16	11	X1+
4	23	Y2-	4	23	X2-
17	10	Y2+	17	10	X2+
5	22	Yclk-	5	22	Xclk-
18	9	Yclk+	18	9	Xclk+
6	21	Y3-	6	21	X3-
19	8	Y3+	19	8	X3+
7	20	100 ohm	7	20	SerTC+
20	7	terminated	20	7	SerTC-
8	19	Z0-	8	19	SerTFG-
21	6	Z0+	21	6	SerTFG+
9	18	Z1-	9	18	CC1-
22	5	Z1+	22	5	CC1+
10	17	Z2-	10	17	CC2+
23	4	Z2+	23	4	CC2-
11	16	Zclk-	11	16	CC3-
24	3	Zclk+	24	3	CC3+
12	15	Z3-	12	15	CC4+
25	2	Z3+	25	2	CC4-
13	13	inner shield	13	13	inner shield
26	26	inner shield	26	26	inner shield

Note:

*Exterior Overshield is connected to the shells of the connectors on both ends. Unused pairs should be terminated in 100 ohms at both ends of the cable. Inner shield is connected to signal ground inside camera

Camera link bit definitions

Signal	Configuration	Remark
CC1	EXSYNC	Keep this signal in low status when idle. The exposure time must not be greater than the camera's allowance—3,000 μ s.
CC2	Spare	
CC3	Direction	
CC4	Spare	

Table 6: Camera Control Configuration

For additional Camera Link documentation refer to the Teledyne DALSA Web site's [Knowledge Center application notes](#).

Camera Timing

Note: Information on setting up the camera's AOI can be found here, [Area of Interest \(AOI\) Setup](#).

RGB 8 bit, CL Base, maximum line rate 20 kHz (4k) and 40 kHz (2k), no AOI and 85 MHz CL clock

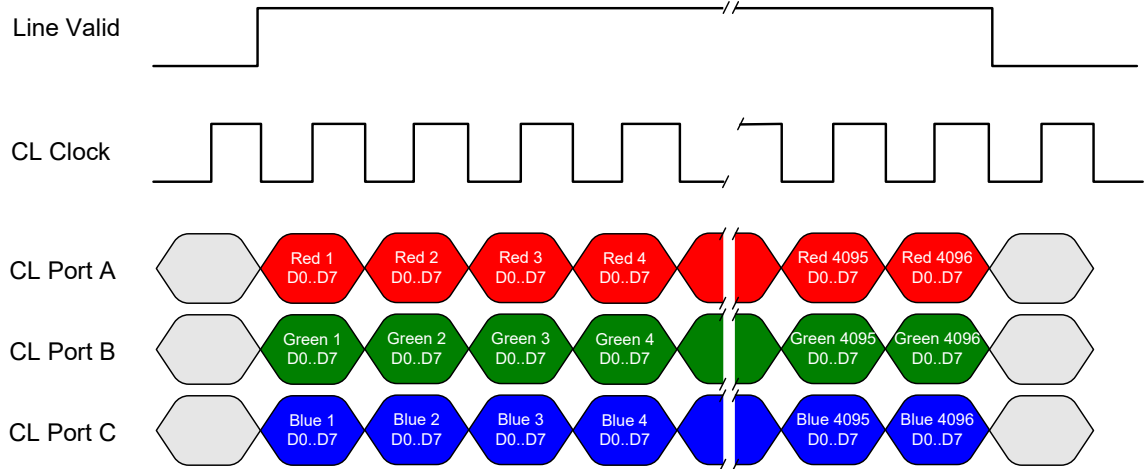

This timing can be used for applications that require line rates only up to 20 kHz and therefore can use Camera Link Base mode with only one cable.

The RGB output format is compatible with the Camera Link specification for Base RGB. Line rates up to 70 kHz can be achieved by using the Area of Interest (AOI) feature; where the smaller the AOI, the greater the potential line rate.

Dual Base RGB 8 bit plus 8 bit monochrome, maximum line rate 40K (2K only), no AOI and 85 MHz CL clock

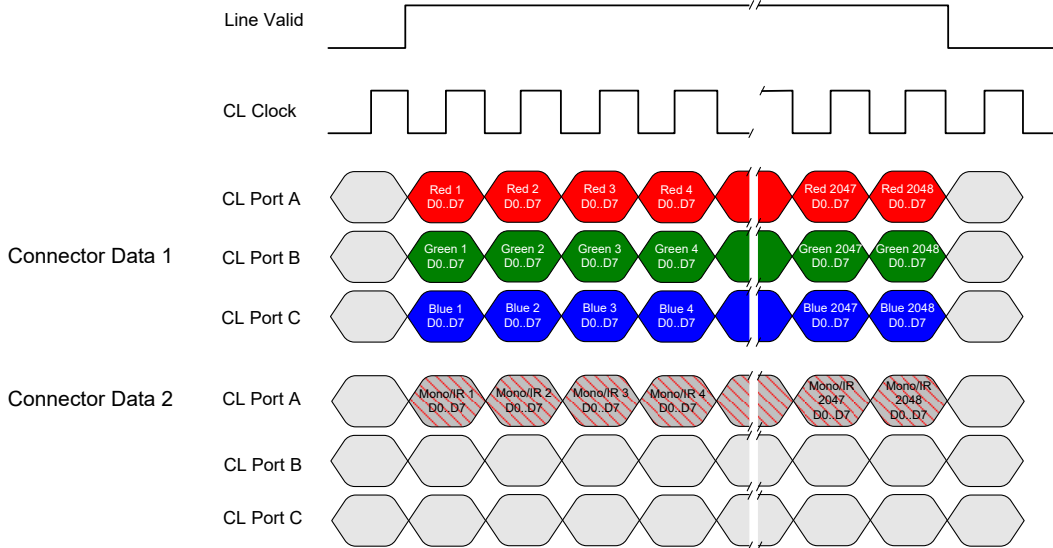

This timing can be used for applications that require line rates only up to 40 kHz and therefore can use Camera Link Dual Base mode with only one cable.

The RGB output format is compatible with the Camera Link specification for Base RGB. Line rates up to 70 kHz can be achieved by using the Area of Interest (AOI) feature; where the smaller the AOI, the greater the potential line rate.

RGB 8 bit, CL Medium, maximum line rate 40 kHz (4k) and 70 kHz (2k), no AOI and 85 MHz CL clock

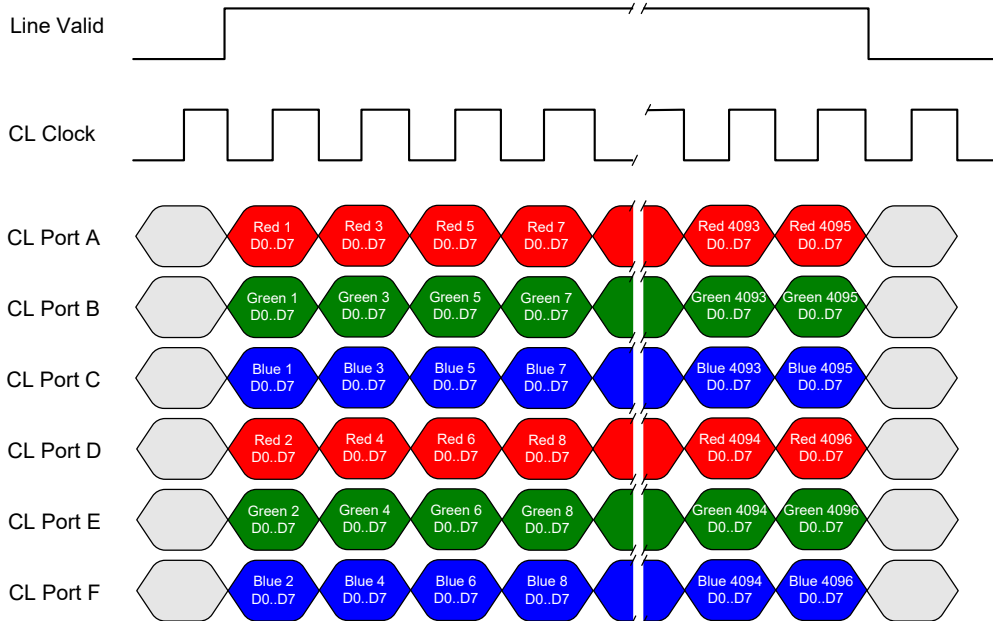

This timing can be used for applications that require line rates up to 40 kHz and therefore must use Camera Link Medium mode and two cables.

The RGB output format is compatible with the Camera Link specification for Medium RGB. Line rates up to 70 kHz can be achieved by using the Area of Interest (AOI) feature; where the smaller the AOI, the greater the potential line rate.

RGB plus monochrome 8 bit CL Medium, maximum line rate 62K (2K only), no AOI and 85 MHz CL clock

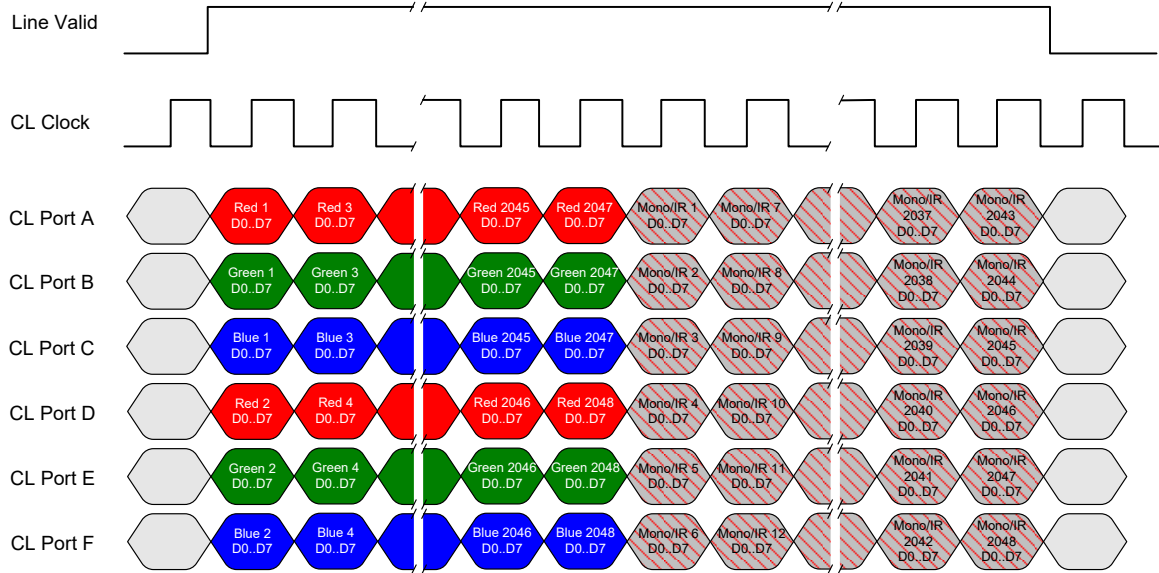

This timing can be used for applications that require line rates up to 60 kHz and therefore must use Camera Link Medium mode and two cables.

The RGB output format is not defined in the Camera Link specification Deca. The RGB format is such that when using a Camera Link frame grabber compatible with the Deca format configured for the mono standard, the R, G and then B pixels will be written sequentially into the frame grabber buffer. This process simplifies the extraction of the RGB data from the frame grabber buffer by the host application. Line rates up to 70 kHz can be achieved by using the Area of Interest (AOI) feature; where the smaller the AOI, the greater the potential line rate.

RGB 8 bit CL Full plus monochrome 8 bit CL full

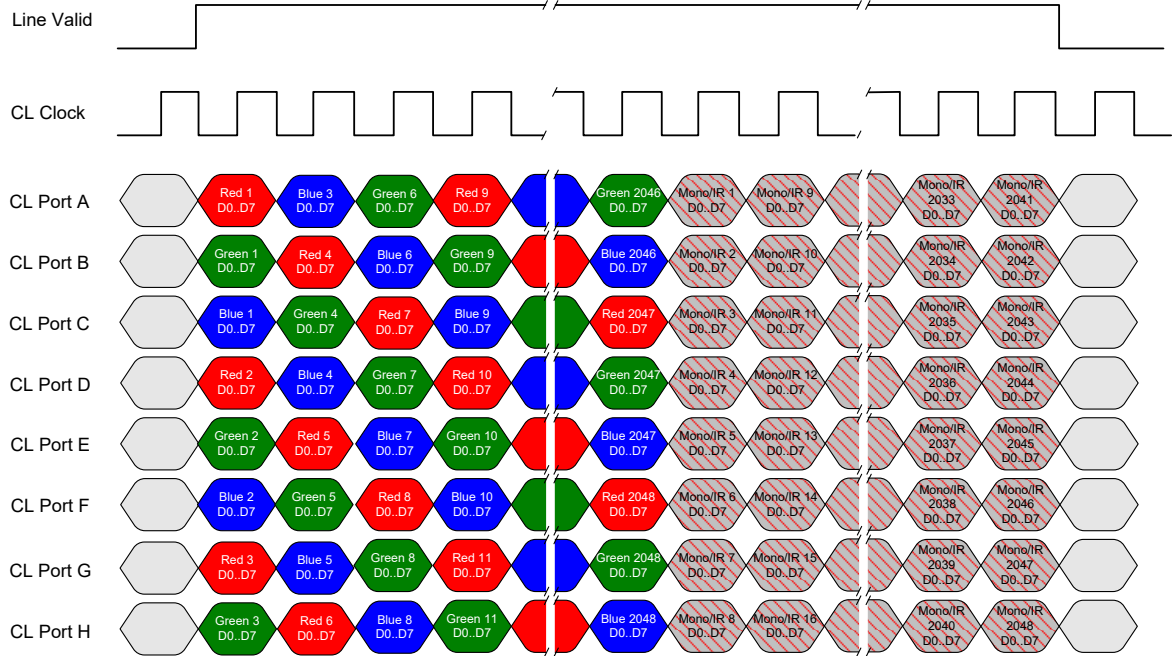

RGB 8 bit CL Full, maximum line rate 55 kHz (4k only), no AOI and 85 MHz CL clock

Note: The inserted dummy pixels at the end.

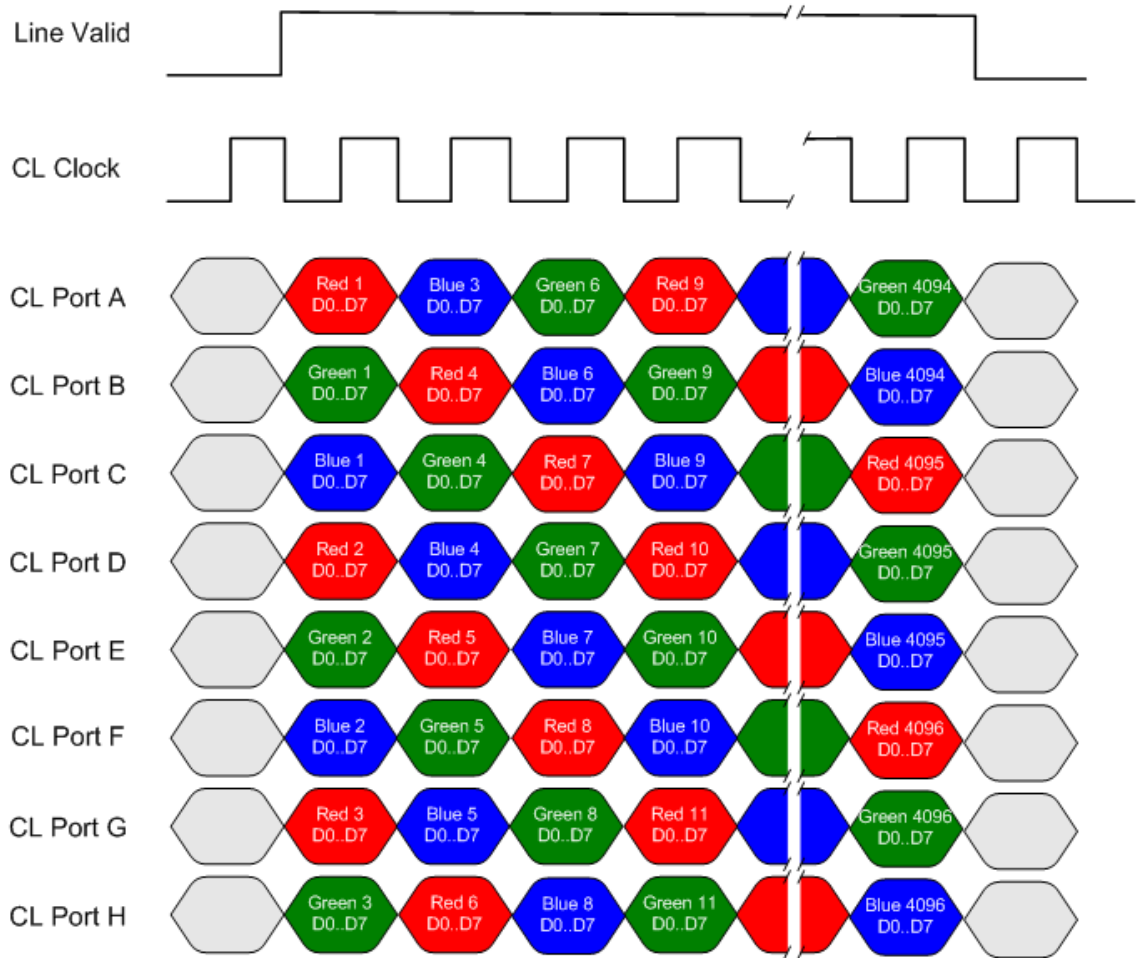

This timing can be used for applications that require line rates up to 55 kHz and therefore must use Camera Link Deca mode and two cables.

The RGB output format is not defined in the Camera Link specification Full. The RGB format is such that when using a Camera Link frame grabber compatible with the Full format configured for the mono standard, the R, G and then B pixels will be written sequentially into the frame grabber buffer. This process simplifies the extraction of the RGB data from the frame grabber buffer by the host application. Line rates up to 70 kHz can be achieved by using the Area of Interest (AOI) feature; where the smaller the AOI, the greater the potential line rate.

RGB 8 bit CL Deca, maximum line rate 68.5 kHz (4k only), no AOI and 85 MHz CL clock

Note: The inserted dummy pixels at the end.

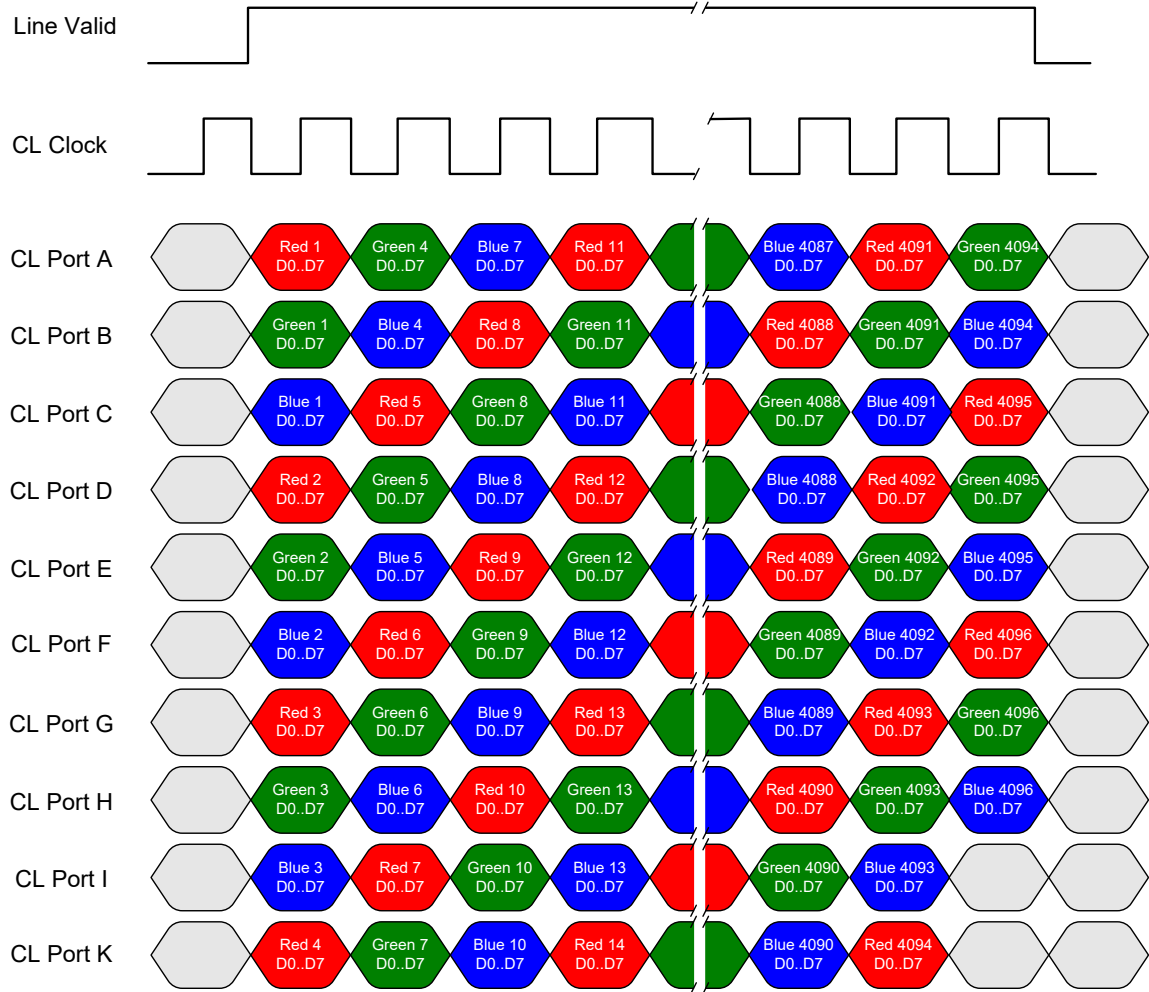

This timing can be used for applications that require line rates up to 68.5 kHz and therefore must use Camera Link Deca mode and two cables.

The RGB output format is not defined in the Camera Link specification Deca. The RGB format is such that when using a Camera Link frame grabber compatible with the Deca format configured for the mono standard, the R, G and then B pixels will be written sequentially into the frame grabber buffer. This process simplifies the extraction of the RGB data from the frame grabber buffer by the host application. Line rates up to 70 kHz can be achieved by using the Area of Interest (AOI) feature; where the smaller the AOI, the greater the potential line rate.

RGB 10 bit CL Medium, maximum line rate 20 kHz (4k) and 40 kHz (2k), no AOI and 85 MHz CL clock

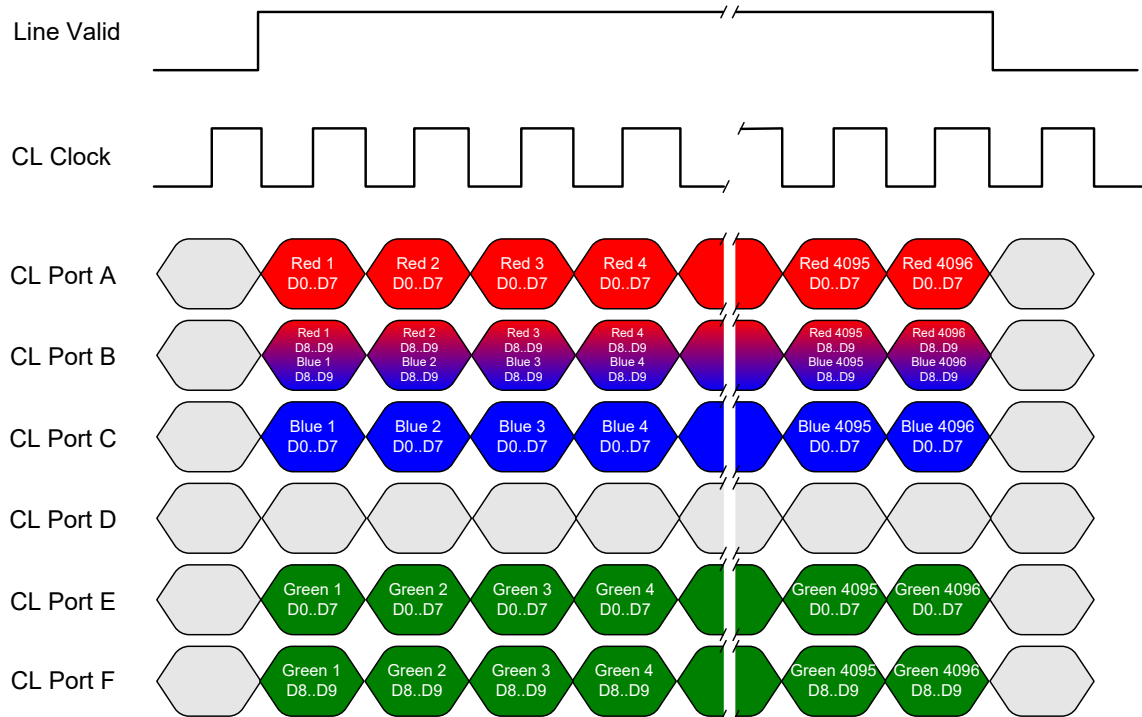

Port B Bit Assignments		Port F Bit Assignments	
D0	Red 8	D0	Green 8
D1	Red 9	D1	Green 9
D2	N/A	D2	N/A
D3	N/A	D3	N/A
D4	Blue 8	D4	N/A
D5	Blue 9	D5	N/A
D6	N/A	D6	N/A
D7	N/A	D7	N/A

This timing can be used for applications that require line rates up to 20 kHz and therefore must use Camera Link Medium mode and two cables.

The RGB output format is compatible with the Camera Link specification for Medium RGB. Line rates up to 70 kHz can be achieved by using the Area of Interest (AOI) feature; where the smaller the AOI, the greater the potential line rate.

RGB 12 bit CL Medium, maximum line rate 20 kHz (4k) and 40 kHz (2k), no AOI and 85 MHz CL clock

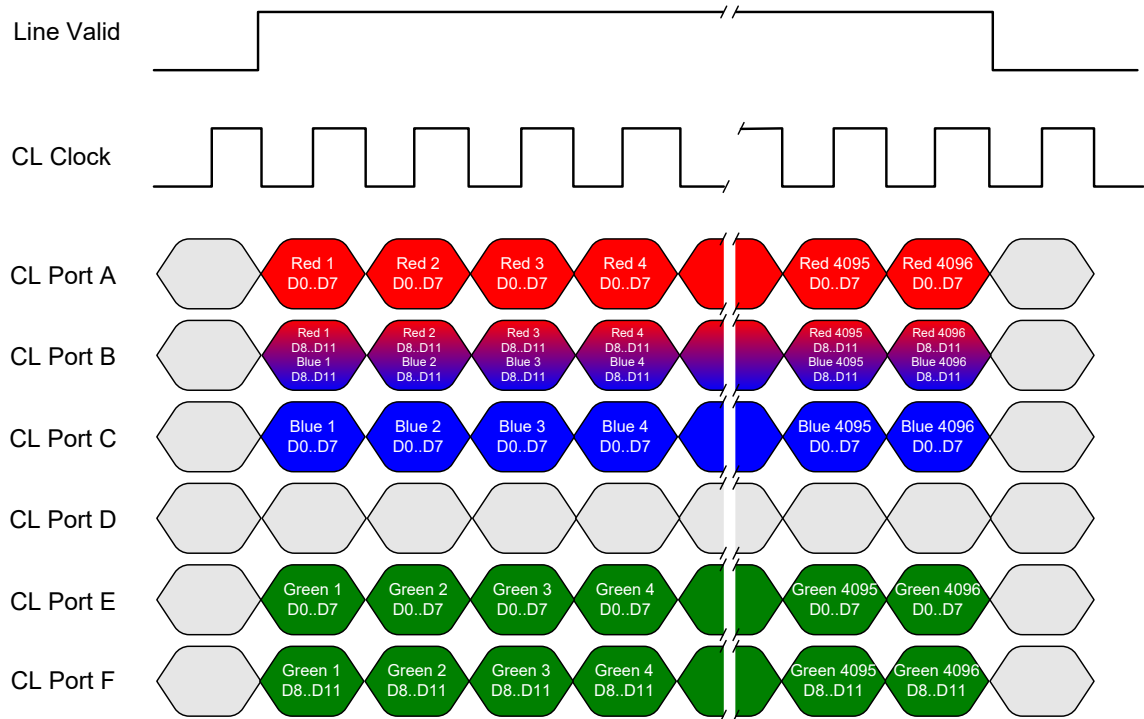

Port B Bit Assignments		Port F Bit Assignments	
D0	Red 8	D0	Green 8
D1	Red 9	D1	Green 9
D2	Red 10	D2	Green 10
D3	Red 11	D3	Green 11
D4	Blue 8	D4	N/A
D5	Blue 9	D5	N/A
D6	Blue 10	D6	N/A
D7	Blue 11	D7	N/A

This timing can be used for applications that require line rates up to 20 kHz and therefore must use Camera Link Medium mode and two cables.

The RGB output format is compatible with the Camera Link specification for Medium RGB. Line rates up to 70 kHz can be achieved by using the Area of Interest (AOI) feature; where the smaller the AOI, the greater the potential line rate.

RGB 12 bit CL Deca, maximum line rate 41.5 kHz (4K) and 70 kHz (2K), no AOI and 85 MHz CL clock

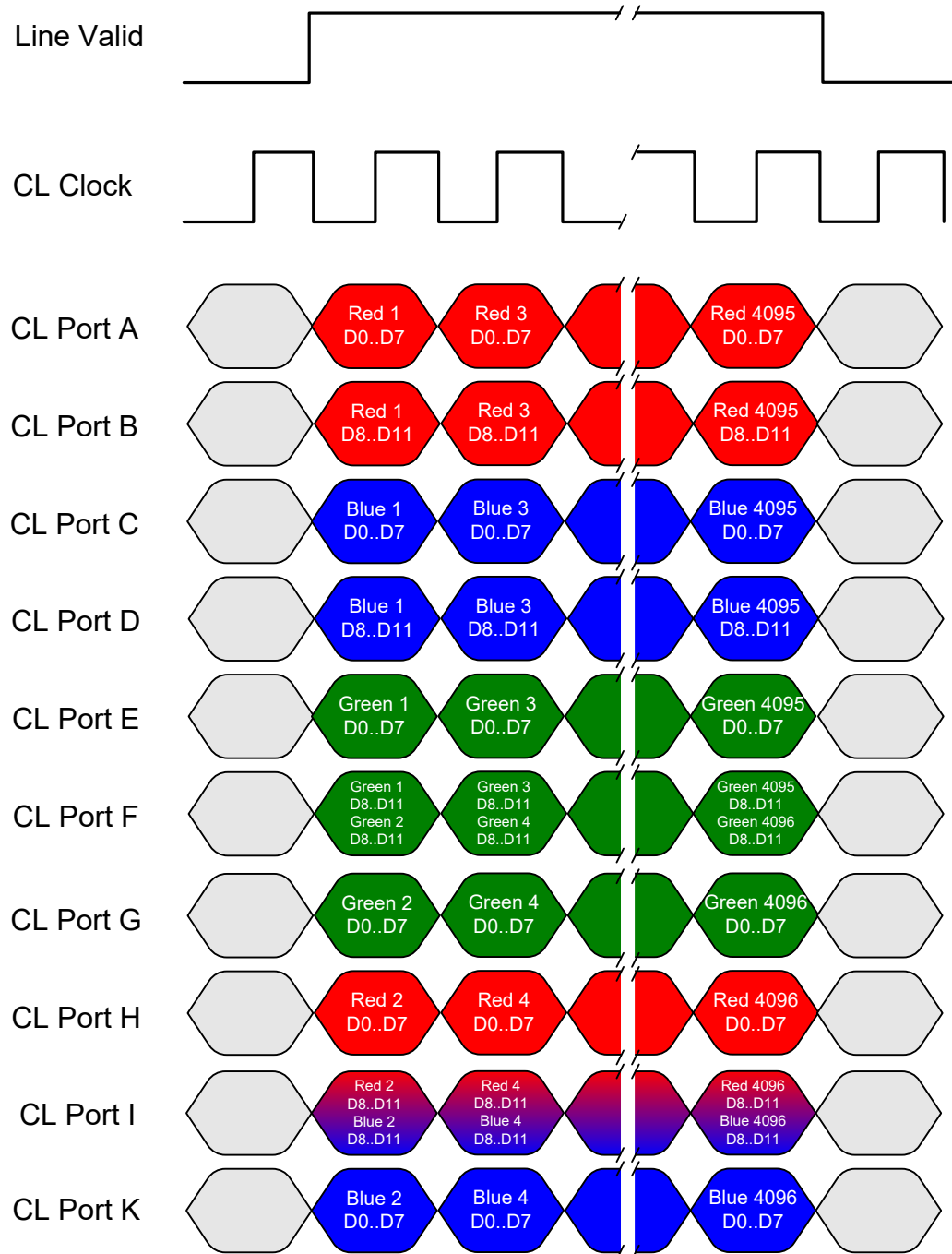

This timing can be used for applications that require line rates up to 41.5 kHz and therefore must use Camera Link Deca mode and two cables.

The RGB output format is not defined in the Camera Link specification Deca. The RGB format is such that when using a Camera Link frame grabber compatible with the Deca format configured for the mono standard, the R, G and then B pixels will be written sequentially into the frame grabber buffer. This

process simplifies the extraction of the RGB data from the frame grabber buffer by the host application. Line rates up to 70 kHz can be achieved by using the Area of Interest (AOI) feature; where the smaller the AOI, the greater the potential line rate.

RGB plus monochrome 12 bit CL Deca, maximum line rate 70 kHz (2K only), no AOI and 85 MHz CL clock

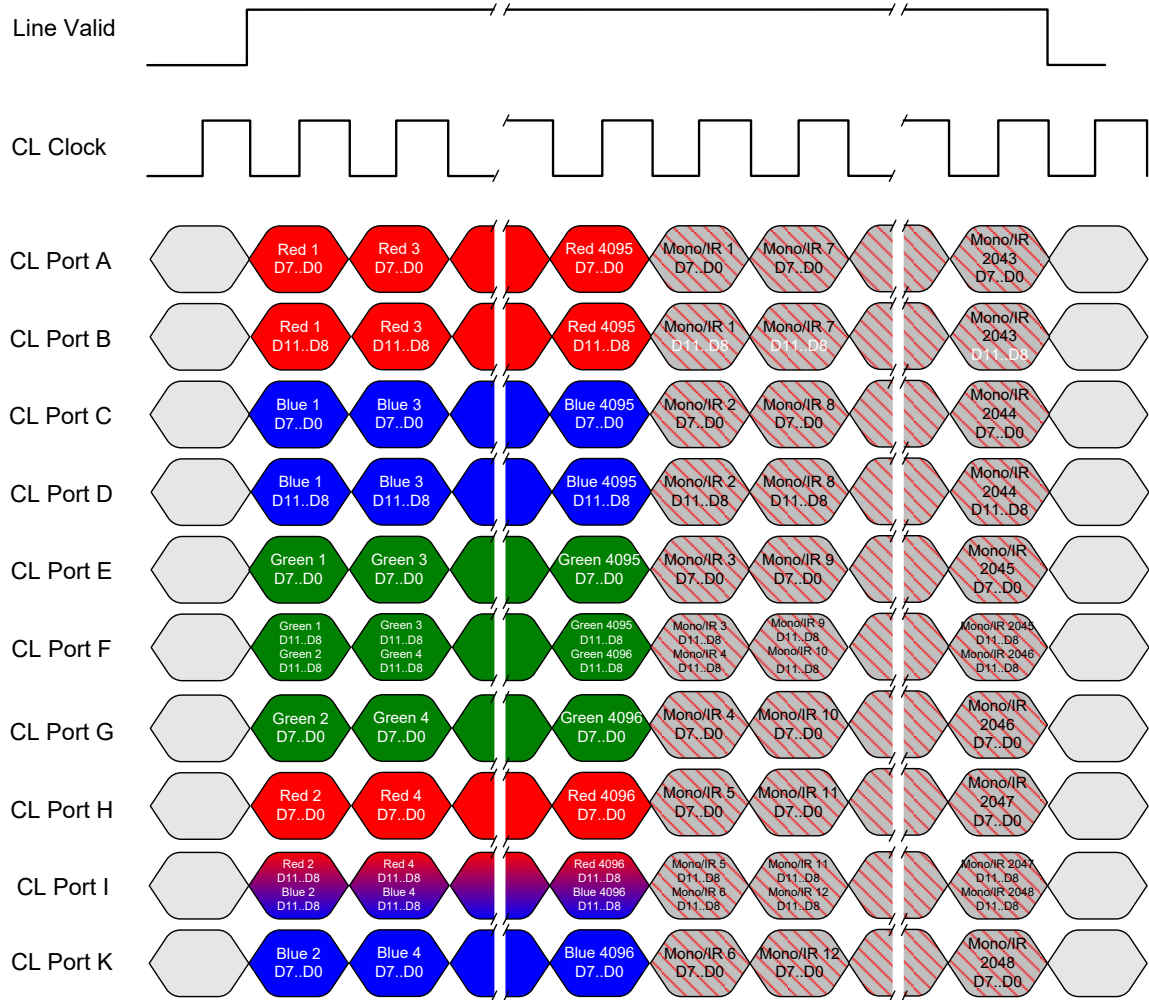

This timing can be used for applications that require line rates up to 70 kHz and therefore must use Camera Link Deca mode and two cables.

The RGB output format is not defined in the Camera Link specification Deca. The RGB format is such that when using a Camera Link frame grabber compatible with the Deca format configured for the mono standard, the R, G and then B pixels will be written sequentially into the frame grabber buffer. This process simplifies the extraction of the RGB data from the frame grabber buffer by the host application. Line rates up to 70 kHz can be achieved by using the Area of Interest (AOI) feature; where the smaller the AOI, the greater the potential line rate.

RGB vs. BGR

The data output can be presented in two alternative formats. RGB or BGR. The previously mentioned output modes are still valid in BGR mode except the positions of the red and the blue are exchanged. Green is still in its previously stated position.

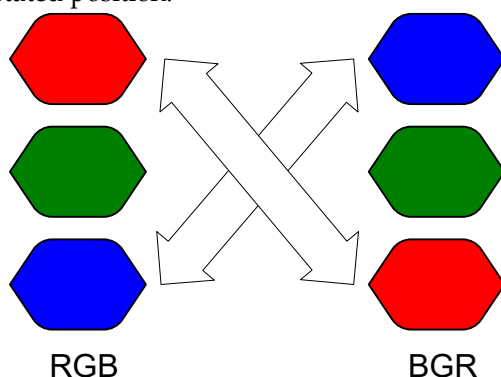

Figure 24 RGB Vs BGR

Custom AOI Rules

- 1) The sensor has pixels numbered 0 to 4096.
- 2) Three values (red, blue, green) are output per pixel in RGB mode.
- 3) Whether mirroring is on or off, 0 is the leftmost pixel.
- 4) Whether mirroring is on or off, AOI 1 is readout first.
- 5) In normal mode, AOI 1 is closest to the sensor's left edge.
- 6) In mirror mode, AOI 1 is closest to the sensor's right edge.

Base and Medium Modes

- 1) The total number of pixels within each AOI must be a multiple of 8 and must be greater than or equal to 40.
- 2) In normal mode, the first pixel of each AOI (AOI left edge) must have the location $8i$, where $i = 0, 1, 2 \dots, 511$ (i.e. 8, 960 are allowed, 12 is not allowed).
- 3) In mirror mode, the first pixel of each AOI (AOI right edge) must have the location $8i + 7$, where $i = 0, 1, 2 \dots, 511$ (i.e. 7, 15, 4095 are allowed, 8 is not allowed).

Deca RGB Mode

- 1) The total number of pixels within each AOI must be a multiple of 40.
- 2) In normal mode, the first pixel of each AOI (AOI left edge) must have the location $8i$, where $i = 0, 1, 2 \dots, 511$ (i.e. 8, 960 are allowed, 12 is not allowed).
- 3) In mirror mode, the first pixel of each AOI (AOI right edge) must have the location $8i + 7$, where $i = 0, 1, 2 \dots, 511$ (i.e. 7, 15, 4095 are allowed, 8 is not allowed).

Camera Link cable quality and length

The maximum allowable Camera Link cable length depends on the quality of the cable used and the Camera Link strobe frequency. Cable quality degrades over time as the cable is flexed. In addition, as the Camera Link strobe frequency is increased the maximum allowable cable length will decrease. We do not guarantee good imaging performance with low quality cables of *any* length. In general, we recommend the use of high quality cables for any cable length.

The following table lists some results achieved using the cameras and a selection of cables and frame grabbers:

Camera Models	Max. Distance Tested	Frame Grabber
P4-CC-02K04T-00-R P4-CC-02K07T-00-R P4-CC-02K07Q-00-R P4-CC-04K04T-00-R P4-CC-04K07T-00-R	15 m	PX8
P4-CC-02K04T-01-R P4-CC-04K04T-01-R	10 m	PX4 and PX8

Input signals, Camera Link

The camera accepts control inputs through the Camera Link SDR26F connector. The camera ships in internal sync, and internally programmed integration.

EXSYNC (Exposure Start)

Line rate can be set internally using the GenICam features. The external control signal EXSYNC is optional and enabled through the user interface. This camera uses the falling edge of EXSYNC to start the exposure period.

The EXSYNC signal tells the camera when to integrate the image, followed by the readout. It can be either an internally generated signal by the camera, or it can be supplied externally via the serial interface. Depending upon the mode of operation the high time of the EXSYNC signal can represent the integration period.

Note: The EXSYNC signal is measured at CC1 and will give a “true” measurement (i.e. within the measurement resolution of 25 ns) even though the camera will only trigger at a maximum of 70 KHz.

Output signals, Camera Link clocking signals

These signals indicate when data is valid, allowing you to clock the data from the camera to your acquisition system. These signals are part of the Camera Link configuration and you should refer to the Camera Link Implementation Road Map, available at our [Knowledge Center](#), for the standard location of these signals.

Clocking Signal	Indicates
LVAL (high)	Outputting valid line
DVAL	Not used
STROBE (rising edge)	Valid data
FVAL	Set to 0

Power connector



WARNING: It is extremely important that you apply the appropriate voltages to your camera. Incorrect voltages may damage the camera. Input voltage requirement: +12 VDC to +24 VDC, 2 Amps. Before connecting power to the camera, test all power supplies.

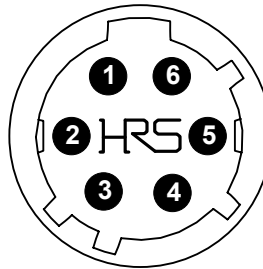

Figure 25: 6-pin Hirose Circular Male Power Plug—Power Connector

Table 7. Power Plug Pinout

Pin	Description	Pin	Description
1	+12 V to +24 V DC	4	GND
2	+12 V to +24 V DC	5	GND
3	+12 V to +24 V DC	6	GND

The camera requires a single voltage input +12 VDC to +24 VDC. The camera meets all performance specifications using standard switching power supplies, although well-regulated linear supplies provide optimum performance.

WARNING: When setting up the camera's power supplies follow these guidelines:



- Apply the appropriate voltages.
- Protect the camera with a 2 amp slow-blow fuse between the power supply and the camera.
- Do not use the shield on a multi-conductor cable for ground.
- Keep leads as short as possible in order to reduce voltage drop.
- Use high-quality supplies in order to minimize noise.

Note: If your power supply does not meet these requirements, then the camera performance specifications are not guaranteed.

LEDs

The camera is equipped with an LED on the back to display the operational status of the camera. The table below summarizes the operating states of the camera and the corresponding LED states. When more than one condition is active, the LED indicates the condition with the highest priority.

Color of Status LED	Meaning
Off	No power or hardware malfunction
Blinking Green	Powering up or calibrating
Green	Ready
Red	Error. Check BiST register for the specific error

Step 3. Establish Communication with the Camera

Power on the camera

Turn on the camera's power supply. You may have to wait while the camera readies itself for operation. The camera must boot fully before it will be recognized by the GUI—the LED shines green once the camera is ready.

Connect to the frame grabber

1. Start Sopera CamExpert (or equivalent Camera Link compliant interface) by double clicking the desktop icon created during the software installation.
2. CamExpert will search for installed Sopera devices. In the Devices list area on the left side, the connected frame grabber will be shown.
3. Select the frame grabber device by clicking on the name.

Note: The first time you set up the camera you will need to establish a communication link between the camera and frame grabber. Instructions are available here in [Appendix F: Camera, Frame Grabber Communication](#).

Connect to the camera

1. Start a new Sopera CamExpert application (or equivalent Camera Link compliant interface) by double clicking the desktop icon created during the software installation.
2. In the Devices list area on the left side, select the COM port below the Camera Link label.

Check LED status

If the camera is operating correctly at this point, the diagnostic LED will shine green.

Software interface



All the camera features can be controlled through the CamExpert interface. For example, under the Sensor Control menu in the camera window you can control the line rate and exposure times.

At this point your host and camera system should be setup and you can verify the camera's operation by retrieving a test pattern and setting the camera's trigger and exposure time.

Using Sopera CamExpert with Piranha4 Cameras

CamExpert is the camera interfacing tool supported by the Sopera library. When used with a Piranha4 camera, CamExpert allows a user to test all camera operating modes. Additionally CamExpert saves the camera user settings configuration to the camera or saves multiple configurations as individual camera parameter files on the host system (*.ccf). CamExpert can also be used to upgrade the camera's software.

An important component of CamExpert is its live acquisition display window which allows immediate verification of timing or control parameters without the need to run a separate acquisition program.

For context sensitive help, click on the  button then click on a camera configuration parameter. A short description of the configuration parameter will be shown in a popup. Click on the  button to open the help file for more descriptive information on CamExpert.

The central section of CamExpert provides access to the camera features and parameters.

Note: The availability of the features is dependent on the CamExpert user setting.

A note on the CamExpert examples shown here: The examples shown for illustrative purposes and may not entirely reflect the features and parameters available from the camera model used in your application.

CamExpert panes

Category	Parameter	Value
Acquisition and Transfer Cont...	Sensor ColorType	CFA_RGB
Camera Information	Internal Line Rate	10000
Camera Control	Measured Line Rate	10000
Digital IO Control	Refresh Measured Line Rate	Press...
Flat Field	Exposure Time Source	Timed
Image Format	Exposure Time Color Selector	All
Transport Layer	Exposure Time	49
Serial Port	Measured Exposure Time	51
Production Features	Refresh Measured Exposure Time	Press...
File Access Control	Direction Source	Internal
	Internal Direction	Forward
	Offset	0
	Gain Selector	SystemGain
	Gain	1
	Color Transformation Matrix Selector	NoCorrectionFactorySet
	Color Transformation Value Selector	Gain00
	Color Transformation Value	1
	Line Spatial Correction	2
	Image Distortion Correction Mode	Off
	Image Distortion Correction Algorithm	ParallaxCorrection
	Image Distortion Correction Line Selector	Red
	Image Distortion Parallax Correction Pixel Stretch	0
	<< Less	

Figure 26. CamExpert's Camera Control Window

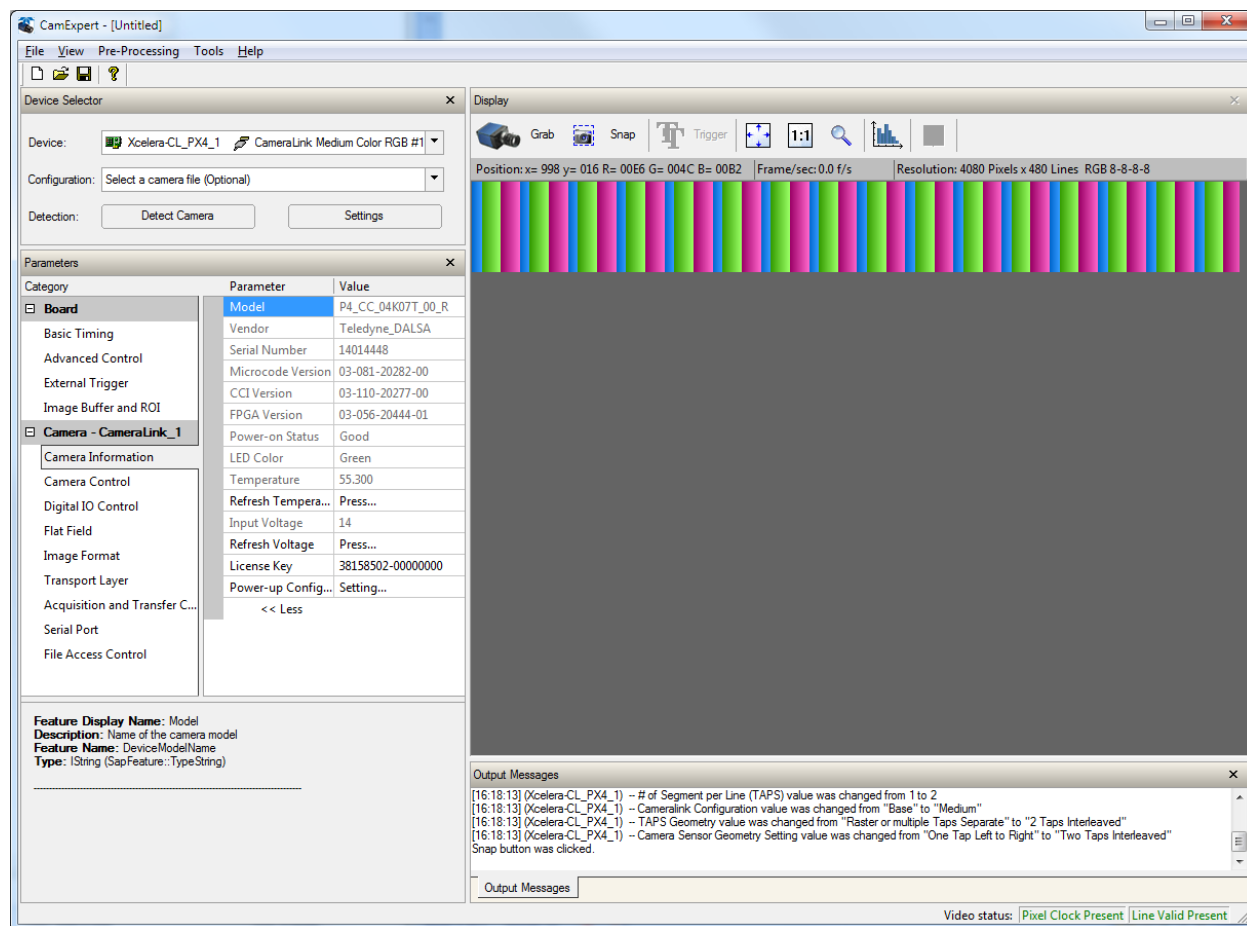
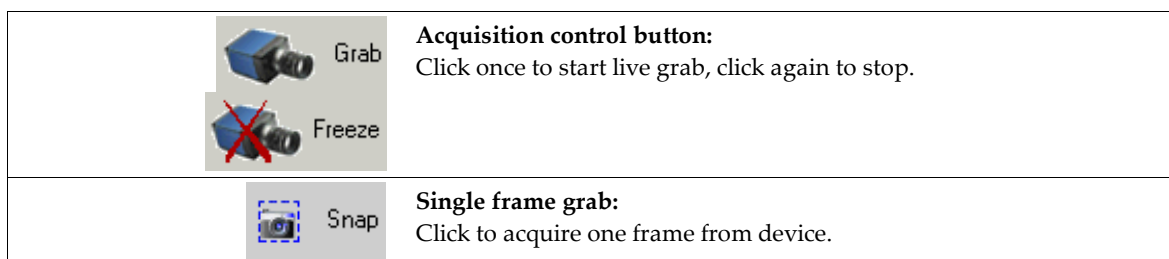

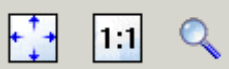



Figure 27. CamExpert GUI showing connected camera

The CamExpert application uses panes to simplify choosing and configuring camera files or acquisition parameters for the installed device.

- **Device Selector pane:** View and select from any installed Sopera acquisition device. Once a device is selected CamExpert will only present acquisition parameters applicable to that device. Optionally select a camera file included with the Sopera installation or saved by the user.
- **Parameters pane:** Allows viewing or changing all acquisition parameters supported by the acquisition device. CamExpert displays parameters only if those parameters are supported by the installed device. This avoids confusion by eliminating parameter choices when they do not apply to the hardware in use.
- **Display pane:** Provides a live or single frame acquisition display. Frame buffer parameters are shown in an information bar above the image window.
- **Control Buttons:** The Display pane includes CamExpert control buttons. These are:



 Trigger	<p>Software trigger button: With the I/O control parameters set to Trigger Enabled / Software Trigger type, click to send a single software trigger command.</p>
	<p>CamExpert display controls: (these do not modify the frame buffer data) Stretch image to fit, set image display to original size, or zoom the image to virtually any size and ratio.</p>
	<p>Histogram / Profile tool: Select to view a histogram or line/column profile during live acquisition or in a still image.</p>

- **Output Message pane:** Displays messages from CamExpert or the device driver.

Review a test image

The camera is now ready to retrieve a test pattern. Select **Image Format Control > Test Pattern** and choose one of the following available test images.

0. Off: Sensor Video

1. Grey Ramp



2. Ramp

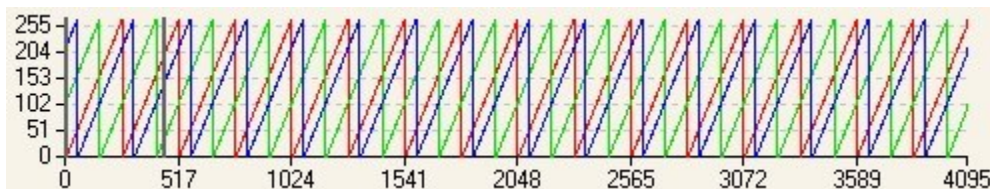

Pixels: {1, 2, 3...}
 Red Value: {0, 1, 2...}
 Green Value: {102, 103, 104...}
 Blue Value: {204, 205, 206...}
 Values roll over at 255.

At this point you are ready to start operating the camera in order to acquire images, set camera functions, and save settings.

4. Camera Operation

Factory Settings

The camera ships and powers up for the first time with the following factory settings:

- Camera Link Medium, 8 bit pixels, 85 MHz
- Internal trigger, line rate 10 kHz
- Internal exposure control, exposure time 30.5 μ s
- Flat field disabled
- User coefficients set to 1x
- Offset 0, System Gain 1x
- White balanced gains all set to 1x
- Color correction, not applied
- Corrected using an 80 mm lens and a magnification of 0.8

Check Camera and Sensor Information

Camera and sensor information can be retrieved via a controlling application—for example, the CamExpert GUI shown in the following examples. Parameters such as camera model, firmware version, sensor characteristics, etc. are read to uniquely identify the connected device.

The camera information parameters are grouped together as members of the Camera Information set.

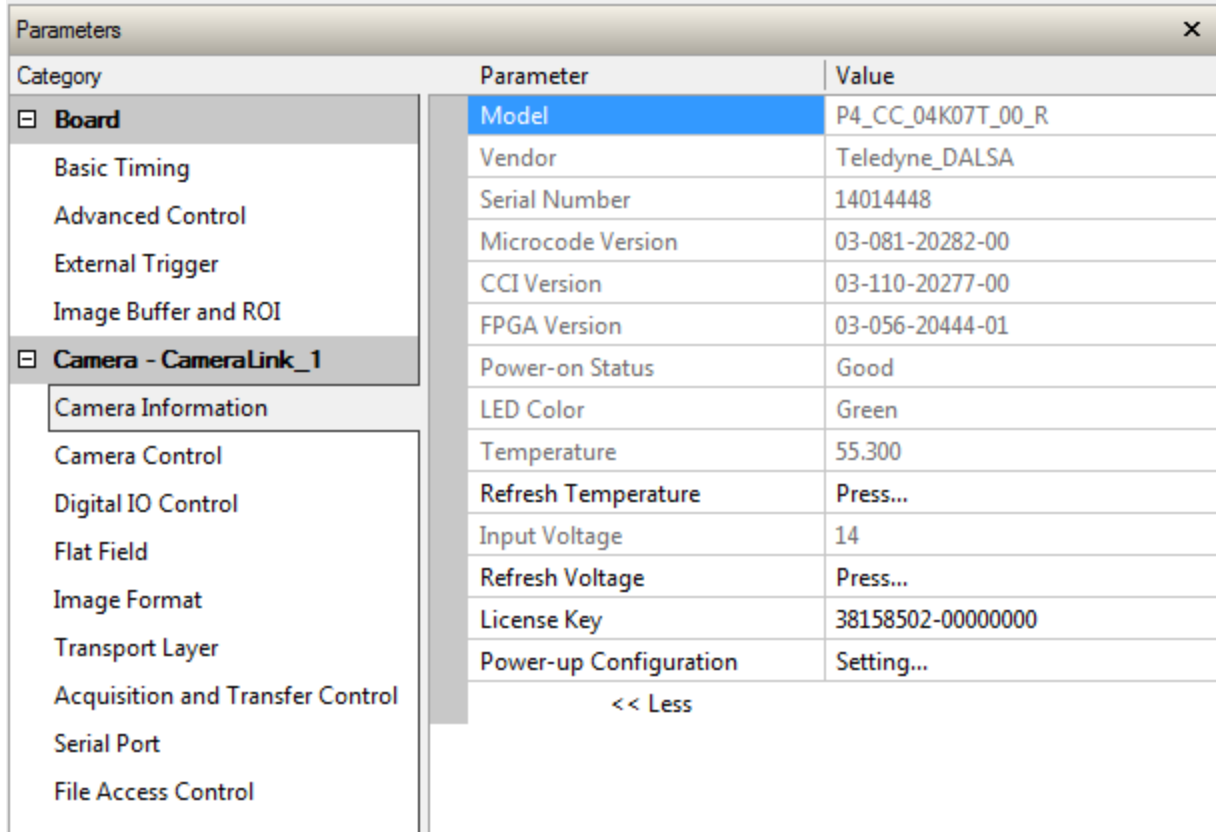

Category	Parameter	Value
Board	Model	P4_CC_04K07T_00_R
	Vendor	Teledyne_DALSA
	Serial Number	14014448
	Microcode Version	03-081-20282-00
	CCI Version	03-110-20277-00
	FPGA Version	03-056-20444-01
	Power-on Status	Good
	LED Color	Green
	Temperature	55.300
	Refresh Temperature	Press...
Camera - CameraLink_1	Input Voltage	14
	Refresh Voltage	Press...
	License Key	38158502-00000000
	Power-up Configuration	Setting...
	<< Less	
	Camera Information	
	Camera Control	
	Digital IO Control	
	Flat Field	
	Image Format	
Transport Layer		
Acquisition and Transfer Control		
Serial Port		
File Access Control		

Figure 28. CamExpert's Camera Information Window

Verify Temperature and Voltage

To determine the voltage and temperature at the camera, use the **Refresh Voltage and Refresh Temperature** features found in the **Camera Information** set.

The temperature returned is the internal temperature in degrees Celsius. For proper operation, this value should not exceed 80 °C. If the camera exceeds the designated temperature it will stop imaging and the LED will turn red. Once you have diagnosed and remedied the issue use the **reset camera** function.

The voltage displayed is the camera's input voltage.

Note: The voltage measurement feature of the camera provides results typically within 1%. This measurement can be used to set the applied voltage to the camera.

Saving and Restoring Camera Settings

The parameters used to select, load and save user sets are grouped together under the Camera Information set of features. There are 8 user sets available and one factory set.

Camera Information	
Parameter	Choices
User Set Default Selector	Select the camera parameters to load when the camera is reset or powered up as the Factory set, or as User Set 1 to 8. Selecting the set from the list automatically saves it as the default set.
User Set Selector	Select the Factory or User set to Save or Load. -Factory Set -User Set 1 to 8.
User Set Load	Load the set specified by User Set Selector to the camera and make it the active / current set.
User Set Save	Save the current set as selected user set.

Description of the Camera Settings

The camera operates in one of three settings:

1. Current session.
2. User setting.
3. Factory setting (read-only).
4. Default setting.

The current settings can be saved (thereby becoming the user setting) using the User Set Save parameter. A previously saved user setting (User Set 1 to 8) or the factory settings can be restored using the User Set Selector and User Set Load parameters.

Either the Factory or one of the User settings can be saved as the Default Setting by selecting the set in the User Set Default Selector. The chosen set automatically saves as the default setting and is the set loaded when the camera is reset or powered up.

The relationship between these three settings is illustrated in Figure 29. Relationship between the Camera Settings:

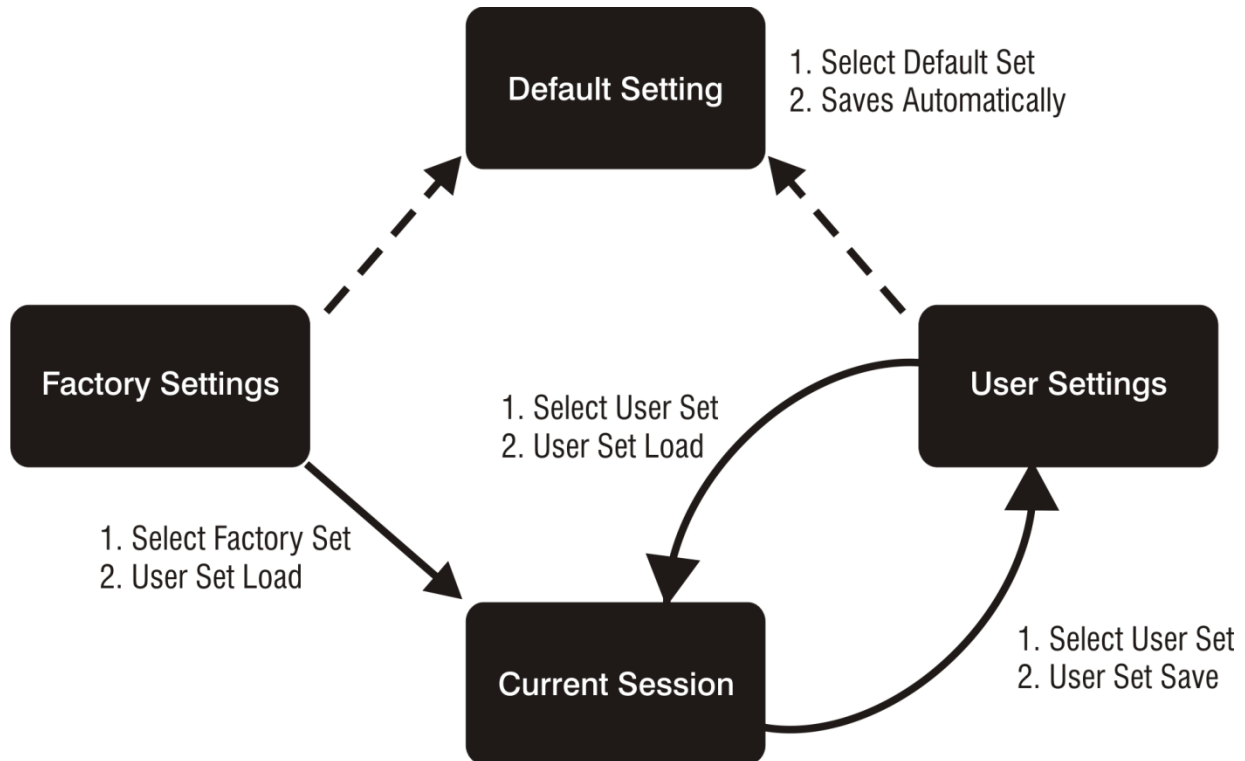

Figure 29. Relationship between the Camera Settings

Active Settings for Current Session

The active setting for the current session is the set of configurations that are operating while the camera is currently running, including all unsaved changes you have made to the settings before saving them.

These active settings are stored in the camera's *volatile* memory and will be lost and cannot be restored if the camera resets or if the camera is powered down or loses power.

To save these settings for reuse the next time you power up or reset the camera, or to protect against losing them in the case of power loss, you must save the current settings using the **User Set Save** parameter. Once saved, the current settings become the selected **User Set**.

User Setting

The user setting is the saved set of camera configurations that you can customize, resave, and restore. By default the user settings are shipped with the same settings as the factory set.

The command **User Set Save** saves the current settings to non-volatile memory as a **User Set**. The camera automatically restores the last saved user settings when it powers up.

To restore the last saved user settings, select the **User Set** parameter you want to restore and then select the **User Set Load** parameter.

Factory Settings

The factory setting is the camera settings that were shipped with the camera and which loaded during the camera's first power-up. To load or restore the original factory settings, at any time, select the **Factory Setting** parameter and then select the **User Set Load** parameter.

Note: By default, the user settings are set to the factory settings.

Default Setting

Either the Factory or one of the User settings can be used as the Default Setting by selecting the set in the User Set Default Selector. The chosen set automatically becomes the default setting and is the set loaded when the camera is reset or powered up.

Camera Link Configuration

Name	Taps	SPF*	Cables
Base	3	8	1
Dual Base (Quadlinear only)	4	8	2
Medium	6	8, 10, 12	2
Full	8	8	2
Deca	10	8, 12	2

*Set Pixel Format (number of bits per pixel)

Trigger Modes

The camera's image exposures are initiated by a trigger event. The trigger event is either a programmable internal signal used in free running mode, an external input used for synchronizing exposures to external triggers, or a programmed function call message by the controlling computer. These triggering modes are described below.

- **Internal trigger (trigger disabled):** The camera free-running mode has a programmable internal timer for line rate and a programmable exposure period.
- **External trigger (trigger enabled):** Exposures are controlled by an external trigger signal. The external trigger signal is the Camera Link control line CC1.

Exposure Controls

Exposure Control modes define the method and timing of how to control the sensor integration period. The integration period is the amount of time the sensor is exposed to incoming light before the video frame data is transmitted to the controlling computer.

- Exposure control is defined as the start of exposure and exposure duration.
- The start of exposure can be an internal timer signal (free-running mode) or an external trigger signal.
- The exposure duration can be programmable (such as the case of an internal timer) or controlled by the external trigger pulse width.

The camera can grab images in one of three ways. You determine the three imaging modes using a combination of the Exposure Mode parameters (including I/O parameters), Exposure Time and Line Rate parameters.

Description	Line Rate	Exposure Time	Trigger Source (Sync)
Internal line rate and exposure time	Internal, programmable	Internal programmable	Internal
External line rate and exposure time	Controlled by EXSYNC pulse	External (EXSYNC)	External
EXSYNC pulse controlling the line rate. Programmed exposure time	Controlled by EXSYNC pulse	Internal programmable	External

Figure 30. Exposure controls

The parameters used to select the imaging modes — trigger sources (sync), exposure time, and line rate — are grouped together as the Camera Controls.

Camera Controls	
Parameter	Description
Line Rate (in Hz)	Camera line rate in Hz. Only available when the start line trigger parameter is disabled (Trigger Mode off).
Exposure Mode	Set the operation mode for the camera's exposure. Trigger Width or Timed. Trigger Width is only available when Trigger Mode is enabled.
	Trigger Width Uses the width of the current line trigger signal pulse to control the exposure duration.
	Timed The exposure duration time is set using the Exposure Time feature and the exposure starts with the Line Start event.
	Exposure Time Selector Internally generated. Allows for an independent exposure time to be applied to each individual color.
Exposure Time	Sets the exposure time (in microseconds). Exposure Mode feature must be set to Timed

Exposure Modes in Detail

1. Internally Programmable Line rate and Internally Programmable Exposure Time (Default)

Line rate is the dominant factor when adjusting the line rate or exposure time. When setting the line rate exposure time will decrease, if necessary, to accommodate the new line rate. When adjusting the exposure time the range is limited by the line rate.

Note: The camera will not set line periods shorter than the readout period.

GenICam parameters to set:

I / O Controls > Trigger Mode > Off

2. External Line Rate and External Exposure Time (Trigger Width)

In this mode, EXSYNC sets both the line period and the exposure time. The rising edge of EXSYNC marks the beginning of the exposure and the falling edge initiates readout. Note:

$$\text{maximum line rate} = \frac{1}{(\text{exposure time} + \text{low time}^*)}$$

*Exposure time must be greater than 8 μ s, and low time greater than 1, 500 ns

GenICam parameters to set:

- **I / O Controls > Trigger Mode > On**
- **Sensor Control > Exposure Mode > Trigger Width**

Warning! When running external line rate and external exposure time, the line rate must not exceed 1 / (exposure time + 1, 000 ns). Under these conditions the exposure time will become indeterminate and result in image artefacts. This is not the case when running internal exposure control.

3. External Line Rate, Programmable Exposure Time

In this mode, the line rate is set externally with the falling edge of EXSYNC generating the rising edge of a programmable exposure time.

GenICam parameters to set:

- **I / O Controls > Trigger Mode > On**
- **Sensor Control > Exposure Mode > Timed**

1. External Trigger Off, Internal Exposure Control
Free running, not synchronized to an external signal

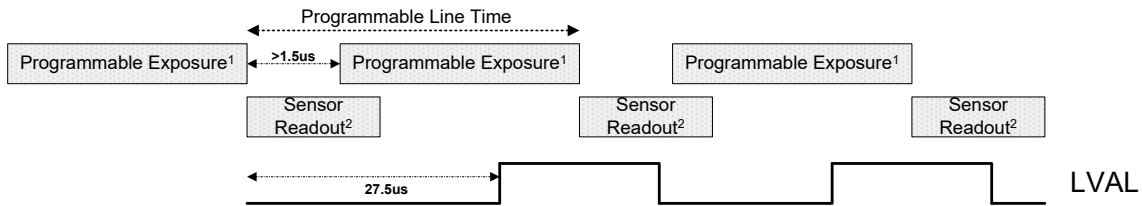

2. External Trigger On, Internal Exposure Control
CC1 Falling edge triggers start of internal exposure³

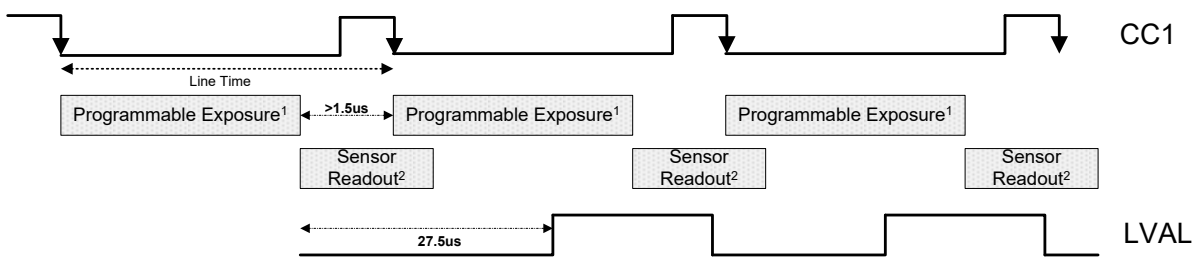

3. External Trigger On, External Exposure Control
CC1 Falling edge triggers start of exposure
CC1 high duration sets the exposure time

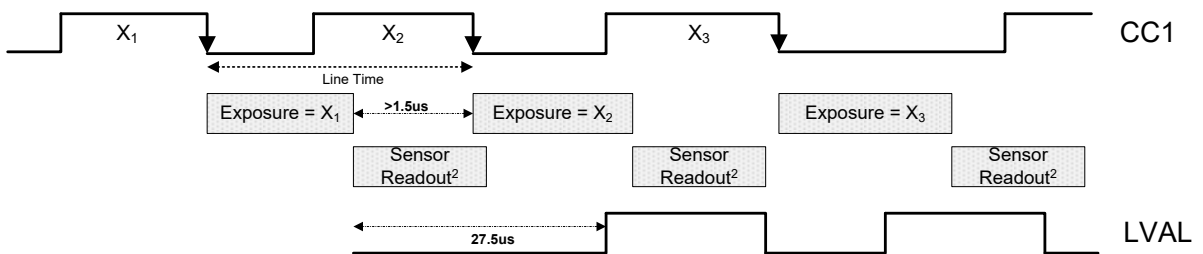

Notes:

1. Exposure time > 7 micro-seconds
2. Sensor Readout time = 14 micro-seconds
3. One additional falling edge during exposure is latched

Figure 31. Exposure Modes

Color exposure time guidelines

The cameras have no limitations on the combinations of the exposure times available for each color except the maximum of 3 ms and the minimum of 7 μ s exposure times. Operating the camera with the conditions stated below will give optimum image performance. Operating the camera beyond the stated limits may be possible but could compromise image quality.

P4-CC-04K ideal operating conditions

For optimum image performance the exposure time for Blue should be great than green or red by more than 1 μ s.

P4-CC-02K trilinear ideal operating conditions

For optimum image performance all of tthe following must be true

1. Blue \geq Red by 1 μ s
2. Blue \geq Green by 1 μ s or Green \geq Blue by 1 μ s
3. Red \geq Green by 1 μ s or Green \geq Red by 1 μ s

P4-CC-02K quadlinear ideal operating conditions

For optimum image performance all of the following must be true

1. Blue \geq Red by 1 μ s
2. Green \geq Mono by 1 μ s
3. Blue \geq Green by 1 μ s or Green \geq Blue by 1 μ s
4. Blue \geq Mono by 1 μ s or Mono \geq Blue by 1 μ s
5. Red \geq Green by 1 μ s or Green \geq Red by 1 μ s
6. Red \geq Mono by 1 μ s or Mono \geq Red by 1 μ s

Set Line Rate

To set the camera's line rate use the line rate parameter, part of the Sensor Controls set. This feature can only be used when the camera is in Internal mode—that is, when the start line trigger is disabled (Trigger Mode Off).

$$\text{maximum line rate} = \frac{1}{(\text{exposure time} + \text{low time}^*)}$$

*Exposure time must be greater than 8 μs , and low time greater than 1,500 ns

Note: The line rate must be less than 1 / (Exposure time + 1500ns). Entering a value that violates this condition will return an error ("Invalid Parameter"). You must adjust these two parameters in the correct sequence to maintain this condition.

If the external line rate exceeds 70 kHz the camera will continue to output data at its maximum line rate of 70 kHz. Though no image artefacts associated with over-speed will occur, you may notice that under over-speed conditions the image will appear compressed and the apparent distance travelled will be reduced.

Camera Control	
Parameter	Description
Line Rate (in Hz)	Camera line rate in a range from 0 Hz to 70 KHz. This feature is only available when the camera is in Internal Mode—line trigger is disabled (Trigger Mode off).

Line Rates	
Camera Link Configuration	Maximum Line Rate
Base	20 kHz (4k models) 40 kHz (2k models)
Medium	41 kHz (2k models only)
Full	55 kHz (4k models only)
Deca	68.5 kHz (Deca RGB8)

Note: 70 kHz line rate can be achieved using AOI mode for all Camera Link Mode. For more information, see [Area of Interest \(AOI\) Setup](#).

Table 8: Line Rates vs. AOI

Camera Model	CL Clock Rates
P4-CC-02K04T-00-R P4-CC-02K07T-00-R P4-CC-02K07Q-00-R P4-CC-04K04T-00-R P4-CC-04K07T-00-R	85 MHz or 66 MHz
P4-CC-02K04T-01-R	66 MHz or 40 MHz
P4-CC-04K04T-01-R	85 MHz or 62 MHz

CL Clock Rate	Number of AOI	CL Configuration	Line Rate Formula (Hz)
85 MHz Or 62 MHz	1	Base RGB8	Max: 70KHz $Rate = \frac{85000000}{AOIwidth1}$ Or $Rate = \frac{62000000}{AOIwidth1}$
		Medium RGB8	Max: 70KHz $Rate = \frac{85000000}{0.5 \times AOIwidth1}$ Or $Rate = \frac{62000000}{0.5 \times AOIwidth1}$
		Full RGB8	Max: 70KHz $Rate = \frac{85000000}{0.375 \times AOIwidth1}$ Or $Rate = \frac{62000000}{0.375 \times AOIwidth1}$
		Deca RGB8	Max: 70KHz $Rate = \frac{85000000}{0.3 \times AOIwidth1}$ Or $Rate = \frac{62000000}{0.3 \times AOIwidth1}$

85 MHz Or 62 MHz	2	Base RGB8	Max: 70KHz $Rate = \frac{85000000}{(AOIwidth1 + AOIwidth2)}$ Or $Rate = \frac{62000000}{AOIwidth1 + AOIwidth2}$
		Medium RGB8	Max: 70KHz $Rate = \frac{85000000}{0.5 \times (AOIwidth1 + AOIwidth2)}$ Or $Rate = \frac{62000000}{0.5 \times (AOIwidth1 + AOIwidth2)}$
		Full RGB8	Max: 70KHz $Rate = \frac{85000000}{0.375 \times (AOIwidth1 + AOIwidth2)}$ Or $Rate = \frac{62000000}{0.375 \times (AOIwidth1 + AOIwidth2)}$
		Deca RGB8	Max: 70KHz $Rate = \frac{85000000}{0.3 \times (AOIwidth1 + AOIwidth2)}$ Or $Rate = \frac{62000000}{0.3 \times (AOIwidth1 + AOIwidth2)}$
85 MHz Or 62 MHz	3	Base RGB8	Max: 70KHz $Rate = \frac{85000000}{(AOIwidth1 + AOIwidth2 + AOIwidth3)}$ Or $Rate = \frac{62000000}{(AOIwidth1 + AOIwidth2 + AOIwidth3)}$
		Medium RGB8	Max: 70KHz $Rate = \frac{85000000}{0.5 \times (AOIwidth1 + AOIwidth2 + AOIwidth3)}$

			<p>Or</p> $Rate = \frac{62000000}{0.5 \times (AOIwidth1 + AOIwidth2 + AOIwidth3)}$
		Full RGB8	<p>Max: 70KHz</p> $Rate = \frac{85000000}{0.375 \times (AOIwidth1 + AOIwidth2 + AOIwidth3)}$ <p>Or</p> $Rate = \frac{62000000}{0.375 \times (AOIwidth1 + AOIwidth2 + AOIwidth3)}$
		Deca RGB8	<p>Max: 70KHz</p> $Rate = \frac{85000000}{0.3 \times (AOIwidth1 + AOIwidth2 + AOIwidth3)}$ <p>Or</p> $Rate = \frac{62000000}{0.3 \times (AOIwidth1 + AOIwidth2 + AOIwidth3)}$
85 MHz	4	Base RGB8	<p>Max: 70KHz</p> $Rate = \frac{85000000}{(AOIwidth1 + AOIwidth2 + AOIwidth3 + AOIwidth4)}$ <p>Or</p> $Rate = \frac{62000000}{(AOIwidth1 + AOIwidth2 + AOIwidth3 + AOIwidth4)}$
Or		Medium RGB8	<p>Max: 70KHz</p> $Rate = \frac{85000000}{0.5 \times (AOIwidth1 + AOIwidth2 + AOIwidth3 + AOIwidth4)}$ <p>Or</p> $Rate = \frac{62000000}{0.5 \times (AOIwidth1 + AOIwidth2 + AOIwidth3 + AOIwidth4)}$
62 MHz		Full RGB8	<p>Max: 70KHz</p> $Rate = \frac{85000000}{0.375 \times (AOIwidth1 + AOIwidth2 + AOIwidth3 + AOIwidth4)}$ <p>Or</p> $Rate = \frac{62000000}{0.375 \times (AOIwidth1 + AOIwidth2 + AOIwidth3 + AOIwidth4)}$

		Deca RGB8	Max: 70KHz $Rate = \frac{85000000}{0.3 \times (AOIwidth1 + AOIwidth2 + AOIwidth3 + AOIwidth4)}$ Or $Rate = \frac{62000000}{0.3 \times (AOIwidth1 + AOIwidth2 + AOIwidth3 + AOIwidth4)}$
--	--	-----------	---

CL Clock Rate	Number of AOI	CL Configuration	Line Rate Formula (Hz)
66 MHz Or 40 MHz	1	Base RGB8	Max: 70KHz $Rate = \frac{66000000}{AOIwidth1}$ Or $Rate = \frac{40000000}{AOIwidth1}$
		Medium RGB8	Max: 70KHz $Rate = \frac{66000000}{0.5 \times AOIwidth1}$ Or $Rate = \frac{40000000}{0.5 \times AOIwidth1}$
		Full RGB8	Max:70KHz $Rate = \frac{66000000}{0.375 \times AOIwidth1}$ Or $Rate = \frac{40000000}{0.375 \times AOIwidth1}$
		Deca RGB8	Max: 70KHz $Rate = \frac{66000000}{0.3 \times AOIwidth1}$ Or $Rate = \frac{40000000}{0.3 \times AOIwidth1}$

66 MHz Or 40 MHz	2	Base RGB8	Max: 70KHz $Rate = \frac{66000000}{(AOIwidth1 + AOIwidth2)}$ Or $Rate = \frac{40000000}{AOIwidth1 + AOIwidth2}$
		Medium RGB8	Max: 70KHz $Rate = \frac{66000000}{0.5 \times (AOIwidth1 + AOIwidth2)}$ Or $Rate = \frac{40000000}{0.5 \times (AOIwidth1 + AOIwidth2)}$
		Full RGB8	Max: 70KHz $Rate = \frac{66000000}{0.375 \times (AOIwidth1 + AOIwidth2)}$ Or $Rate = \frac{40000000}{0.375 \times (AOIwidth1 + AOIwidth2)}$
		Deca RGB8	Max: 70KHz $Rate = \frac{66000000}{0.3 \times (AOIwidth1 + AOIwidth2)}$ Or $Rate = \frac{40000000}{0.3 \times (AOIwidth1 + AOIwidth2)}$
66 MHz Or 40 MHz	3	Base RGB8	Max: 70KHz $Rate = \frac{66000000}{(AOIwidth1 + AOIwidth2 + AOIwidth3)}$ Or $Rate = \frac{40000000}{(AOIwidth1 + AOIwidth2 + AOIwidth3)}$
		Medium RGB8	Max: 70KHz $Rate = \frac{66000000}{0.5 \times (AOIwidth1 + AOIwidth2 + AOIwidth3)}$

			<p>Or</p> $Rate = \frac{40000000}{0.5 \times (AOIwidth1 + AOIwidth2 + AOIwidth3)}$
		Full RGB8	<p>Max: 70KHz</p> $Rate = \frac{66000000}{0.375 \times (AOIwidth1 + AOIwidth2 + AOIwidth3)}$ <p>Or</p> $Rate = \frac{40000000}{0.375 \times (AOIwidth1 + AOIwidth2 + AOIwidth3)}$
		Deca RGB8	<p>Max: 70KHz</p> $Rate = \frac{66000000}{0.3 \times (AOIwidth1 + AOIwidth2 + AOIwidth3)}$ <p>Or</p> $Rate = \frac{40000000}{0.3 \times (AOIwidth1 + AOIwidth2 + AOIwidth3)}$
66 MHz Or 40 MHz	4	Base RGB8	<p>Max: 70KHz</p> $Rate = \frac{66000000}{(AOIwidth1 + AOIwidth2 + AOIwidth3 + AOIwidth4)}$ <p>Or</p> $Rate = \frac{40000000}{(AOIwidth1 + AOIwidth2 + AOIwidth3 + AOIwidth4)}$
		Medium RGB8	<p>Max: 70KHz</p> $Rate = \frac{66000000}{0.5 \times (AOIwidth1 + AOIwidth2 + AOIwidth3 + AOIwidth4)}$ <p>Or</p> $Rate = \frac{40000000}{0.5 \times (AOIwidth1 + AOIwidth2 + AOIwidth3 + AOIwidth4)}$
		Full RGB8	<p>Max: 70KHz</p> $Rate = \frac{66000000}{0.375 \times (AOIwidth1 + AOIwidth2 + AOIwidth3 + AOIwidth4)}$ <p>Or</p> $Rate = \frac{40000000}{0.375 \times (AOIwidth1 + AOIwidth2 + AOIwidth3 + AOIwidth4)}$

		Deca RGB8	Max: 70KHz $Rate = \frac{66000000}{0.3 \times (AOIwidth1 + AOIwidth2 + AOIwidth3 + AOIwidth4)}$ Or $Rate = \frac{40000000}{0.3 \times (AOIwidth1 + AOIwidth2 + AOIwidth3 + AOIwidth4)}$
--	--	-----------	---

Set Exposure Time

To set the camera's exposure time, use the **Exposure Time** parameter—a member of the Sensor Controls set. This feature is only available when the **Exposure Mode** parameter is set to **Timed**. The allowable exposure range is from 7 µs to 3,000 µs, dependent on the value of the internal line rate.

GenICam parameters:

Sensor Controls > Exposure Time (Timed Exposure Mode) > 8 µs to 3,000 µs.

Control Gain and Black Level

The cameras provide gain and black level adjustments in the digital domain for the CMOS sensor. The gain and black level controls can make small compensations to the acquisition in situations where lighting varies and the lens iris cannot be easily adjusted. The user can evaluate gain and black level by using CamExpert.

The parameters that control gain and black level are grouped together in the Sensor Controls set.

Sensor Controls	
Black Level	Apply a digital addition after an FPN correction: ± 1/8 of the available range of -32 to +31 in 8-bit mode, -128 to +127 in 10-bit mode, and -512 to +511 in 12-bit mode.
Gain	Set the gain as an amplification factor applied to the video signal across all pixels: 1x to 10x.

Set Image Size

To set the height of the image, and therefore the number of lines to scan, use the parameters grouped under the Image Format Control set.

Image Format Control	
Control the size of the transmitted image	
Width	Width of the image.
Height	Height of the image in lines.
Pixel Format	8 bit depth to Camera Link.
Test Image Selector	Select an internal test image: Off Color Ramp Grey Ramp

Set Baud Rate

The baud rate sets the speed (in bits per second—bps) of the serial communication port and is available as part of the Serial Port Control parameters.

Serial Port Control		
Action	Parameter	Options
Control the baud rate used by the camera's serial port	Baud Rate	9600 (factory default) 19200 57600 115200 230400* 460800* 921600* Note: During connection CamExpert automatically sets the camera to maximum allowable baud. *Your system requires a Px8 frame grabber to achieve these baud rates.
Number of bits per character used in the serial port	Data Size	8
Parity of the serial port	Parity	None
Number of stop bits per character used in the serial port	Number of Stop Bits	1

Pixel Format

Use the Pixel Format feature, found in the **Image Format Control** set, to select the format of the pixel to use during image acquisition.

Image Format Control	
Parameter	Description
Pixel Format	RGB8, RGB10, RGB12

Binning

Note: the binning feature is used by the 4K model of camera only. (This feature does not apply to the 2K models.)

Binning is the combining of two image sensor pixels to form a new combined pixel. A binned image using the same exposure settings as a non-binned image will show an improved signal-to-noise ratio, reduced scanning times (due to lower spatial resolution) and save as a smaller image file size compared with a non-binned image, at the expense of lower image resolution.

For this camera, the default horizontal binning value is 1.

The **Binning Horizontal** features in the **Image Format Control** set represents the number of horizontal pixels that will be combined (added) together.

Image Format Control	
Parameter	Description
BinningHorizontal	This feature represents the number of horizontal photo-sensitive cells that must be combined (added) together.

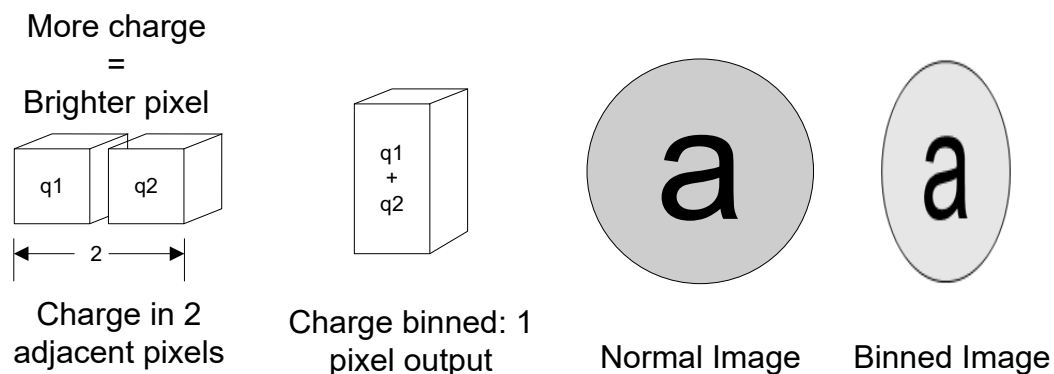

Figure 32. Horizontal Binning

Camera Direction Control

Found in the **I/O Control** > **Direction Control** set of features.

Direction Control	
Parameter	Description
Sensor Scan Direction	This command lets you select the Internal or external direction control . Use this feature to accommodate object direction change on a web and to mount the camera "upside down."
Scan Direction	Read the current direction.

Pixel Readout Direction (Mirroring Mode)

Set the tap readout from left to right or from right to left. This feature is especially useful if you want to mount the camera "upside down."

Image Format Control	
Parameter	Description
ReverseX	Off: All pixels are read out from left to right. On: All pixels are read out from right to left.

Resetting the Camera

The feature **Camera Reset**, part of the **Transport Layer** set, resets the camera. The camera resets with the default settings, including a baud rate of 9600.

Camera Information	
Parameter	Description
Camera Reset	Resets the camera and puts in the default settings, including a 9600 baud rate.

Calibrating the Camera

Important Note: to ensure best results, the conditions under which you calibrate the camera (e.g. temperature and illumination) should be as close to the actual operating conditions as possible.

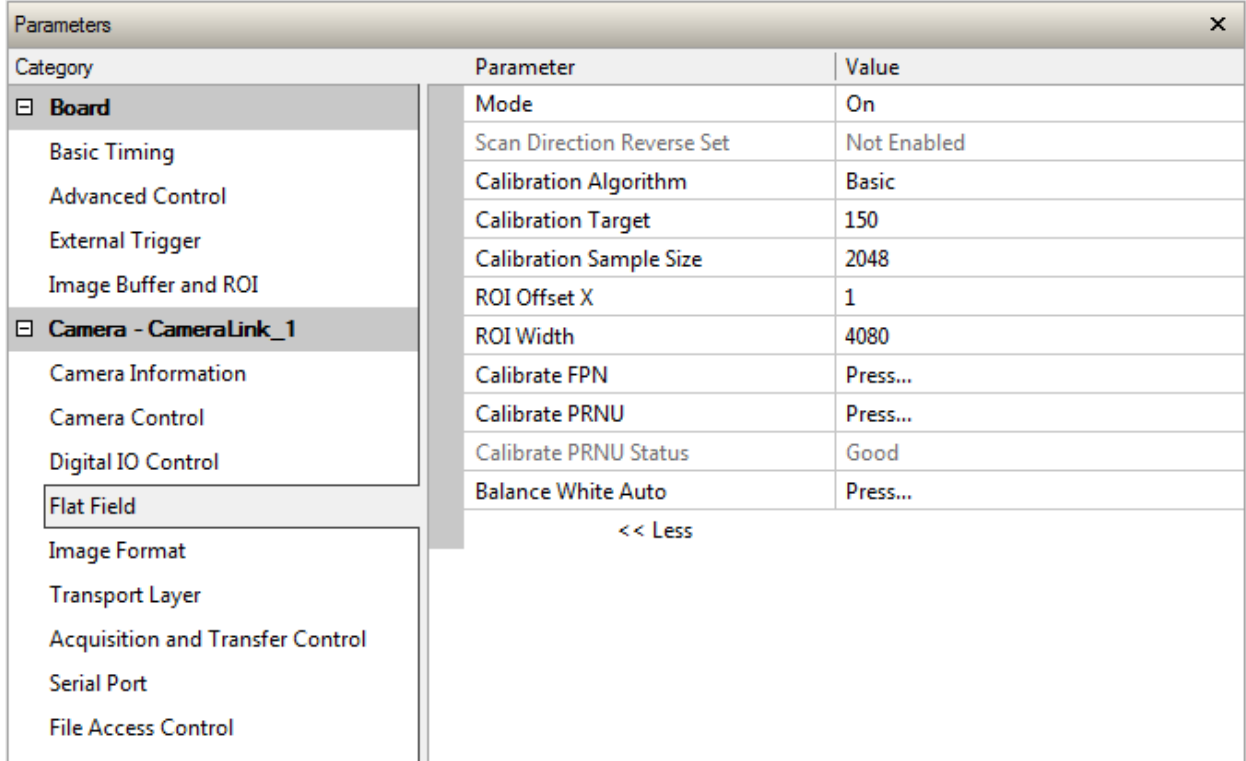

Figure 33: Flat Field Calibration in CamExpert

Overview

The following diagram and accompanying description explain the cameras signal processing chain. Each element shown, with the exception of color interpolation, is user programmable.

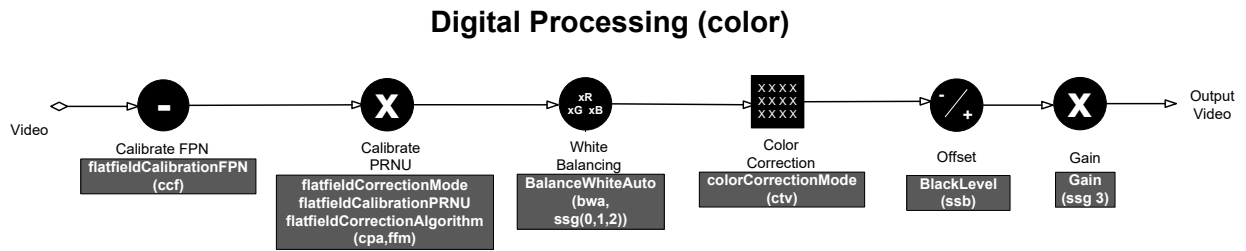

Figure 34: Camera Calibration Process.

Digital Processing

1. Fixed pattern noise (FPN) calibration is used to subtract any residual dark level that may occur in the application.

2. Photo response non uniformity (PRNU) calibration is used to correct for variations in the illumination intensity and / or lens vignetting. When performed, this calibration will cause the camera to have a flat response to a white target in the field of view. The output target value for PRNU calibration can be set by the user.
3. The white balancing gains are used set the red, green and blue response to equal values with a white target in the field of view. The white balance gains can be individually set by the user, but will be overridden by the camera when the camera performs PRNU calibration or white balancing commands.
4. Color correction is available for those users that need to compensate for the spectral transmission characteristics of the sensors color filters and the customers light source. This can be achieved by imaging the Gretag Macbeth® ColorChecker® illuminated by the application's light source and processing the image using a color correction demonstration tool provided as part of Teledyne DALSA's Sopera Processing software. This tool will generate the desired color correction file that can be downloaded to the camera.

Note: Prior to imaging the Gretag Macbeth ColorChecker, the camera should have been calibrated with a white reference in place of the Gretag Macbeth ColorChecker and color correction must be turned off. The calibration process will ensure the camera output is uniform and white balanced.

5. The introduction of offsets has limited value in color applications as it will cause color distortion. However, the camera has the ability to add either a positive or negative offset as required by a specific application. This offset can be useful when trying to measure dark noise where black level clipping will cause an error in the result.
6. A single overall system gain is applied equally to all three colors. It will therefore not cause color distortion when changed.
7. A factory setting for white LED color correction can be applied, if needed.

Calibration

The goal of calibration is to produce a uniform, white balanced and, if required, color corrected image at the desired level out of the camera when it is imaging a uniform white object, using the optical setup of the user's application.

The user should configure the camera to use the EXSYNC and exposure timing they desire plus adjust the light level for normal operation. The lens should be at the desired magnification, aperture and be in focus. As the white reference located at the object plane will be in focus, any features on its surface (e.g. dust, scratches) will end up in the calibration profile of the camera. To avoid this, use a clean white plastic or ceramic material, not paper. Ideally, the white object should move during the calibration process as the averaging process of the camera will diminish the effects on any small variation in the white reference.

The user may wish to start the calibration process by evaluating the characteristics of their setup with no calibration enabled. This can be readily achieved by disabling FPN, PRNU & color correction coefficients, setting white balance red, green and blue gains to one, and the system gain to one.

Begin by adjusting the system gain until the peak intensity of the three colors is at the desired DN level. You may want to use the white balance gains to adjust the peak of each color to be a similar DN value, but this is not necessary. Before proceeding any further, it is desirable to complete an FPN calibration.

This is best performed using a lens cap to ensure no light gets into the camera. Once complete, a PRNU calibration can be performed using a target value you want all the pixels to achieve. This target value can be higher or lower than the peak values you observed while initially setting up the camera. Once PRNU calibration is complete, it will take several seconds, all three colors should be at the target value, white balance gains will have been adjusted to suit the cameras optimum setup for a balanced white output, and the correction coefficient will be enabled. The system gain will remain as originally set. The coefficient and gain parameters, timing and control configuration etc can be stored in any one of eight user sets and automatically retrieved at power up or by user selection. If a color correction matrix is desired, the user can download and save a color correction file derived from the process described above. **Note:** For the color correction to be effective, the camera should have a white balanced output when color correction is off.



CamExpert has a default timeout of 20 seconds per command, which is too short for the FFC calibration to run fully. You can change the default timeout by setting a command line argument in the short-cut:

- Right click on the short-cut in the start menu and select properties.
- Add `-timeout 60` to increase the command timeout to 60 seconds (See below). **Note** that you must include a character space between the closing quotation mark in the target and the hyphen before the timeout value.
- Repeat for desktop short-cut

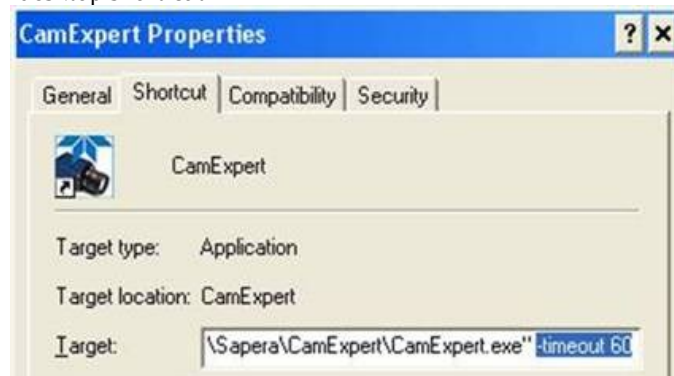

Figure 35: Setting the camera's timeout value

1. Flat Field

This Flat Field set contains a number of features that are used to correct image distortion due to lens vignetting and uneven illumination. .

Note:

1. Flat field coefficients consist of an offset and gain for each pixel.
2. These are the first user corrections applied to the image.
3. The flat field coefficients are saved and loaded with the user set.

Flat Field	
Parameter	Description
flatfieldCorrectionMode	<ol style="list-style-type: none"> 1. Off – Flat field correction coefficients are not applied. 2. On – Flat field correction coefficients are applied. 3. Initialize – Sending this value will reset all current coefficients (offsets to 0 and gains to 1x).
flatfieldCorrectionAlgorithm	<ol style="list-style-type: none"> 1. Basic – Direct calculation of coefficients based on current average line values and target. 2. LowPass – A low pass filter is first applied to the current average line values before calculating the coefficients. Use this algorithm if the calibration target is not uniform white or it is not possible to defocus the image. Because of the low pass filter this algorithm is not able to correct pixel-to-pixel variations and so it is preferable to use the “Basic” algorithm if possible.
flatfieldCalibrationTarget	<ol style="list-style-type: none"> 1. After calibration all pixels will be scaled to output this level <ul style="list-style-type: none"> • Range: 8 bit, 0 to 255 DN
flatfieldCalibrationSampleSize	<ol style="list-style-type: none"> 1. Number of lines to average when calibrating 2. 2048 or 4096
flatfieldCalibrationROIOffsetX	<ol style="list-style-type: none"> 1. Together with “flatfieldCalibrationROIWidth” specifies the range of pixels to be calibrated. Pixel coefficients outside this range are not changed. It is possible to calibrate different regions sequentially.
flatfieldCalibrationROIWidth	
flatfieldCalibrationFPN	<ol style="list-style-type: none"> 1. Save average line (of “flatfieldCalibrationSampleSize” rows). This is the first user correction applied – it is subtracted from each line. 2. This feature may not be of use to many users as the camera already subtracts true “dark current”, but it may be useful for some to provide a per pixel offset correction. 3. Range 0 to 31 DN, 8 bit 4. Default value is 0 DN for each pixel
flatfieldCalibrationPRNU	<ol style="list-style-type: none"> 1. Use “flatfieldCorrectionAlgorithm” to calculate the per pixel gain to achieve the specified target output. 2. Max 15.9998x 3. Default 1x

2. Contrast Enhancement

The offset and gain features can be used to maximize the use of the output dynamic range. Typical use is to subtract the minimum pixel value expected and then gain up to the maximum pixel value to approach full scale. This process may be useful for applications that process the RGB colors individually.

Offset

1. Single value added to each pixel
2. Range -32 to +31 DN
3. Positive values may be used to measure dark noise

Gain

1. Floating point digital multiplier applied to each pixel
2. Range 1x to 10x

Note: An application note describing a color transformation matrix calibration (document #03-032-20181) is available. Please contact Teledyne DALSA Support for more information.

Appendix A: GenICam Commands

This appendix lists the available GenICam camera features. Access these features using the CamExpert interface.

Features listed in the description table but tagged as *Invisible* are typically reserved for Teledyne DALSA Support or third party software usage, and not typically required by end user applications.

A note on the CamExpert examples shown here: The examples shown for illustrative purposes and may not entirely reflect the features and parameters available from the camera model used in your application.

Camera Information Category

Camera information can be retrieved via a controlling application. Parameters such as camera model, firmware version, etc. are read to uniquely identify the connected P4 device. These features are typically read-only.

The Camera Information Category groups information specific to the individual camera. In this category the number of features shown is identical whether the view is Beginner, Expert, or Guru.

Features listed in the description table but tagged as *Invisible* are usually for Teledyne DALSA or third party software usage—not typically needed by end user applications.

Parameters		
Category	Parameter	Value
[-] Board	Model	P4_CC_04K07T_00_R
Basic Timing	Vendor	Teledyne_DALSA
Advanced Control	Serial Number	14014448
External Trigger	Microcode Version	03-081-20282-00
Image Buffer and ROI	CCI Version	03-110-20277-00
[-] Camera - CameraLink_1	FPGA Version	03-056-20444-01
Camera Information	Power-on Status	Good
Camera Control	LED Color	Green
Digital IO Control	Temperature	32.200
Flat Field	Refresh Temperature	Press...
Image Format	Input Voltage	14
Transport Layer	Refresh Voltage	Press...
Acquisition and Transfer Control	License Key	38158502-00000000
Serial Port	Power-up Configuration	Setting...
File Access Control	<< Less	

Camera information feature descriptions

The following table describes these parameters along with their view attributes and in which version of the device the feature was introduced. Additionally the Device Version column will indicate which parameter is a member of the DALSA Features Naming Convention (using the tag **DFNC**), versus the GenICam Standard Features Naming Convention (SFNC not shown).

The Device Version number represents the camera software functional group, not a firmware revision number.

Display Name	Feature	Description	Device Version & View
Vendor Name	DeviceVendorName	Displays the device vendor name. (RO)	1.00 Beginner
Model Name	DeviceModelName	Displays the device model name. (RO)	1.00 Beginner
Device Version	DeviceVersion	Displays the device version. This tag will also highlight if the firmware is a beta or custom design. (RO)	1.00 Beginner
Manufacturer Info	DeviceManufacturerInfo	This feature provides extended manufacturer information about the device. (RO)	1.00 Beginner
Firmware Version	DeviceFirmwareVersion	Displays the currently loaded firmware version number. Firmware files have a unique number and have the .cbf file extension. (RO)	1.00 Beginner

Serial Number	DeviceID	Displays the device's factory set camera serial number. (RO)	1.00 Beginner
Power-up Configuration Selector	UserSetDefaultSelector	Selects the camera configuration set to load and make active on camera power-up or reset. The camera configuration sets are stored in camera non-volatile memory. (RW)	1.00 Beginner
Factory Setting	Default	Load factory default feature settings	
UserSet1	UserSet1	Select the user defined configuration UserSet 1 as the Power-up Configuration.	
UserSet2	UserSet2	Select the user defined configuration UserSet 2 as the Power-up Configuration	
UserSet3	UserSet3	Select the user defined configuration UserSet 3 as the Power-up Configuration	
UserSet4	UserSet4	Select the user defined configuration UserSet 4 as the Power-up Configuration.	
UserSet5	UserSet5	Select the user defined configuration UserSet 5 as the Power-up Configuration.	
UserSet6	UserSet6	Select the user defined configuration UserSet 6 as the Power-up Configuration.	
UserSet7	UserSet7	Select the user defined configuration UserSet 7 as the Power-up Configuration.	
UserSet8	UserSet8	Select the user defined configuration UserSet 8 as the Power-up Configuration.	
User Set Selector	UserSetSelector	Selects the camera configuration set to load feature settings from or save current feature settings to. The Factory set contains default camera feature settings. (RW)	1.00 Beginner
Factory Setting	Default	Select the default camera feature settings saved by the factory	
UserSet 1	UserSet1	Select the User-defined Configuration space UserSet1 to save to or load from features settings previously saved by the user.	
UserSet 2	UserSet2	Select the User-defined Configuration space UserSet2 to save to or load from features settings previously saved by the user.	
UserSet3	UserSet3	Select the User-defined Configuration space UserSet3 to save to or load from features settings previously saved by the user.	
UserSet4	UserSet4	Select the User-defined Configuration space UserSet4 to save to or load from features settings previously saved by the user.	
UserSet5	UserSet5	Select the User-defined Configuration space UserSet5 to save to or load from features settings previously saved by the user.	
UserSet6	UserSet6	Select the User-defined Configuration space UserSet6 to save to or load from features settings previously saved by the user.	

UserSet7	UserSet7	Select the User-defined Configuration space UserSet7 to save to or load from features settings previously saved by the user.	
UserSet8	UserSet8	Select the User-defined Configuration space UserSet8 to save to or load from features settings previously saved by the user.	
Power-on User Set	UserSetDefaultSelector	Allows the user to select between the factory set and 1 to 8 usersets to be loaded at power up	1.00 Beginner
Current User Set	UserSetSelector	Points to which user set (1-8) or factory set that is loaded or saved when the UserSetLoad or UserSetSave command is used	1.00 Beginner
Load Configuration	UserSetLoad	Loads the camera configuration set specified by the User Set Selector feature, to the camera and makes it active. (W)	1.00 Beginner
Save Configuration	UserSetSave	Saves the current camera configuration to the user set specified by the User Set Selector feature. The user sets are located on the camera in non-volatile memory. (W)	1.00 Beginner
Device Built-In Self Test Status	deviceBISTStatus	Determine the status of the device using the 'Built-In Self Test'. Possible return values are device-specific. (RO)	1.00 DFNC Beginner
LED Color	deviceLEDColorControl	Displays the status of the LED on the back of the camera. (RO)	1.00 DFNC Beginner
Temperature	DeviceTemperature	Displays the internal operating temperature of the camera. (RO)	1.00 DFNC Beginner
Refresh Temperature	refreshTemperature	Press to display the current internal operating temperature of the camera.	1.00 DFNC Beginner
Input Voltage	deviceInputVoltage	Displays the input voltage to the camera at the power connector (RO)	1.00 DFNC Beginner
Refresh Voltage	refreshVoltage	Press to display the current input voltage of the camera at the power connector	1.00 DFNC Beginner
License Key	securityUpgrade		1.00 DFNC Guru

Camera configuration selection dialog

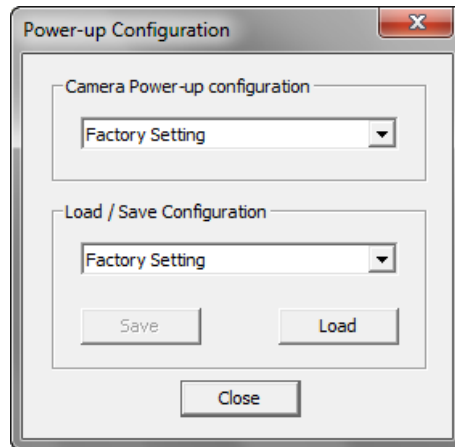

CamExpert provides a dialog box which combines the features to select the camera power up state and for the user to save or load a camera state from memory.

Camera power-up configuration

The first drop list selects the camera configuration state to load on power-up (see feature *UserSetDefaultSelector*). The user chooses from one factory data set or one of two possible user saved states.

User set configuration management

The second drop list allows the user to change the camera configuration anytime after a power-up (see feature *UserSetSelector*). To reset the camera to the factory configuration, select *Factory Setting* and click Load. To save a current camera configuration, select User Set 1 to 8 and click Save. Select a saved user set and click Load to restore a saved configuration.

Camera Control Category

The P4 camera controls, as shown by CamExpert, groups sensor specific parameters. This group includes controls for line rate, exposure time, scan direction, and gain. Parameters in gray are read only, either always or due to another parameter being disabled. Parameters in black are user set in CamExpert or programmable via an imaging application.

Category	Parameter	Value
Acquisition and Transfer Cont...	Sensor ColorType	CFA_RGB
Camera Information	Internal Line Rate	10000
Camera Control	Measured Line Rate	10000
Digital IO Control	Refresh Measured Line Rate	Press...
Flat Field	Exposure Time Source	Timed
Image Format	Exposure Time Color Selector	All
Transport Layer	Exposure Time	49
Serial Port	Measured Exposure Time	51
Production Features	Refresh Measured Exposure Time	Press...
File Access Control	Direction Source	Internal
	Internal Direction	Forward
	Offset	0
	Gain Selector	SystemGain
	Gain	1
	Color Transformation Matrix Selector	NoCorrectionFactorySet
	Color Transformation Value Selector	Gain00
	Color Transformation Value	1
	Line Spatial Correction	2
	Image Distortion Correction Mode	Off
	Image Distortion Correction Algorithm	ParallaxCorrection
	Image Distortion Correction Line Selector	Red
	Image Distortion Parallax Correction Pixel Stretch	0
	<< Less	

Camera control feature descriptions

The following table describes these parameters along with their view attribute and minimum camera firmware version required. Additionally the firmware column will indicate which parameter is a member of the DALSA Features Naming Convention (DFNC), versus the GenICam Standard Features Naming Convention (SFNC not shown).

The Device Version number represents the camera software functional group, not a firmware revision number.

Display Name	Feature	Description	Device Version & View
Sensor Color Type	sensorColorType	Defines the camera sensor color type. (RO)	1.00 DFNC
	CFA_RGB	Sensor color type is RGB	Beginner
Internal Line Rate	AcquisitionLineRate	Specifies the camera internal line rate, in Hz when Trigger mode set to internal. Note that any user entered value is automatically adjusted to a valid camera value.	1.00 Beginner
Measured Line Rate	measureLineRate	Specifies the line rate provided to the camera by either internal or external source (RO)	1.00 Beginner
Refresh measured line rate	refreshMeasureLineRate	Press to show the current line rate provided to the camera by either internal or external sources	1.00 Beginner
Exposure Time Source Timed	ExposureMode	Sets the operation mode for the camera's exposure (or shutter). (RO)	1.00 Beginner
	Timed	The exposure duration time is set using the Exposure Time feature and the exposure starts with a LineStart event.	
Trigger Width	TriggerWidth	Uses the width of the trigger signal pulse to control the exposure duration.	
Exposure Time Selector	exposureTimeSelector	Selects which color that the exposure time value is to apply to.	1.00 Beginner
	All	Exposure time setting applies to all colors.	
	Red	Exposure time setting applies to red.	
	Green	Exposure time setting applies to green.	
	Blue	Exposure time setting applies to blue.	
Exposure Time	ExposureTime	Sets the exposure time (in microseconds) when the Exposure Mode feature is set to Timed.	1.00 Beginner
	measureExposureTime	Specifies the exposure time provided to the camera by either internal or external source (RO)	1.00 Beginner
Refreshed measured exposure time	refreshMeasureExposureTime	Press to display the current exposure time provided to the camera.	1.00 Beginner

Direction Source	sensorScanDirectionSource	Direction determined by value of SensorScanDirection	1.00 Beginner
	Internal External	Direction control determined by value on CC3	
Internal Direction	sensorScanDirection	When ScanDirectionSource set to Internal, determines the direction of the scan	1.00 Beginner
	Forward Reverse		
Gain Selector	GainSelector	Selects which gain is controlled when adjusting gain features.	1.00 Beginner
	SystemGain	Apply a digital gain adjustment to the entire image	
	Red	Apply a digital gain adjustment to the red channel only	
	Green	Apply a digital gain adjustment to the green channel only	
	Blue	Apply a digital gain adjustment to the blue channel only	
	Mono	Apply a digital gain adjustment to the mono channel only	
Gain	Gain	Sets the selected gain as an amplification factor applied to the image.	1.00 Beginner
Offset	BlackLevel	Controls the black level as an absolute physical value. This represents a DC offset applied to the video signal, in DN (digital number) units.	1.00 Beginner
Color Transformation Selector	colorTransformationSelector	Allows the user to select between two factory programmed matrixes or two user loaded sets	1.00 Beginner
	WhiteLEDFactorySet	Color Correction Matrix for a white LED	
	NoCorrectionFactorySet	No correction	
	MatrixUserSet1	User programmable/loaded correction matrix	
	MatrixUserSet2	User programmable/loaded correction matrix	

Color Transformation Value Selector	ColorTransformationValueSelector Gain00 Gain01 Gain02 Gain10 Gain11 Gain12 Gain20 Gain21 Gain22 Offset1 Offset2 Offset3	Allows the user to manually adjust correction value in the matrix	1.00 Beginner																				
		<table border="1"> <tr> <td></td> <td>Red</td> <td>Green</td> <td>Blue</td> <td>Offset</td> </tr> <tr> <td>Red</td> <td>Gain00</td> <td>Gain01</td> <td>Gain02</td> <td>Offset1</td> </tr> <tr> <td>Green</td> <td>Gain10</td> <td>Gain11</td> <td>Gain12</td> <td>Offset2</td> </tr> <tr> <td>Blue</td> <td>Gain30</td> <td>Gain31</td> <td>Gain32</td> <td>Offset3</td> </tr> </table>		Red	Green	Blue	Offset	Red	Gain00	Gain01	Gain02	Offset1	Green	Gain10	Gain11	Gain12	Offset2	Blue	Gain30	Gain31	Gain32	Offset3	
	Red	Green	Blue	Offset																			
Red	Gain00	Gain01	Gain02	Offset1																			
Green	Gain10	Gain11	Gain12	Offset2																			
Blue	Gain30	Gain31	Gain32	Offset3																			
Color Transformation Value	ColorTransformationValue	Value entered as pointed to by ColorTransformationValueSelector, $-16 < \text{value} < 16$	1.00 Beginner																				
Line Spatial Correction	sensorLineSpatialCorrection	Set the number of rows between imaging lines	1.00 Beginner																				
Image Distortion Correction Mode	imageDistortionCorrectionMode	Used enable parallax correction	1.00 Beginner																				
Image Distortion Correction Algorithm	imageDistortionCorrectionAlgorithm	Read only – Parallax Correction	1.00 Beginner																				
Image Distortion Correction Line Selector	imageDistortionCorrectionLineSelector	Used to select between the green or red lines to be corrected	1.00 Beginner																				
Image Distortion Parallax Correction Pixel Stretch	imageDistortionParallaxCorrectionPixelStretch	Value entered indicates the number pixels to be shifted to correct the color alignment	1.00 Beginner																				

Independent Exposure Control

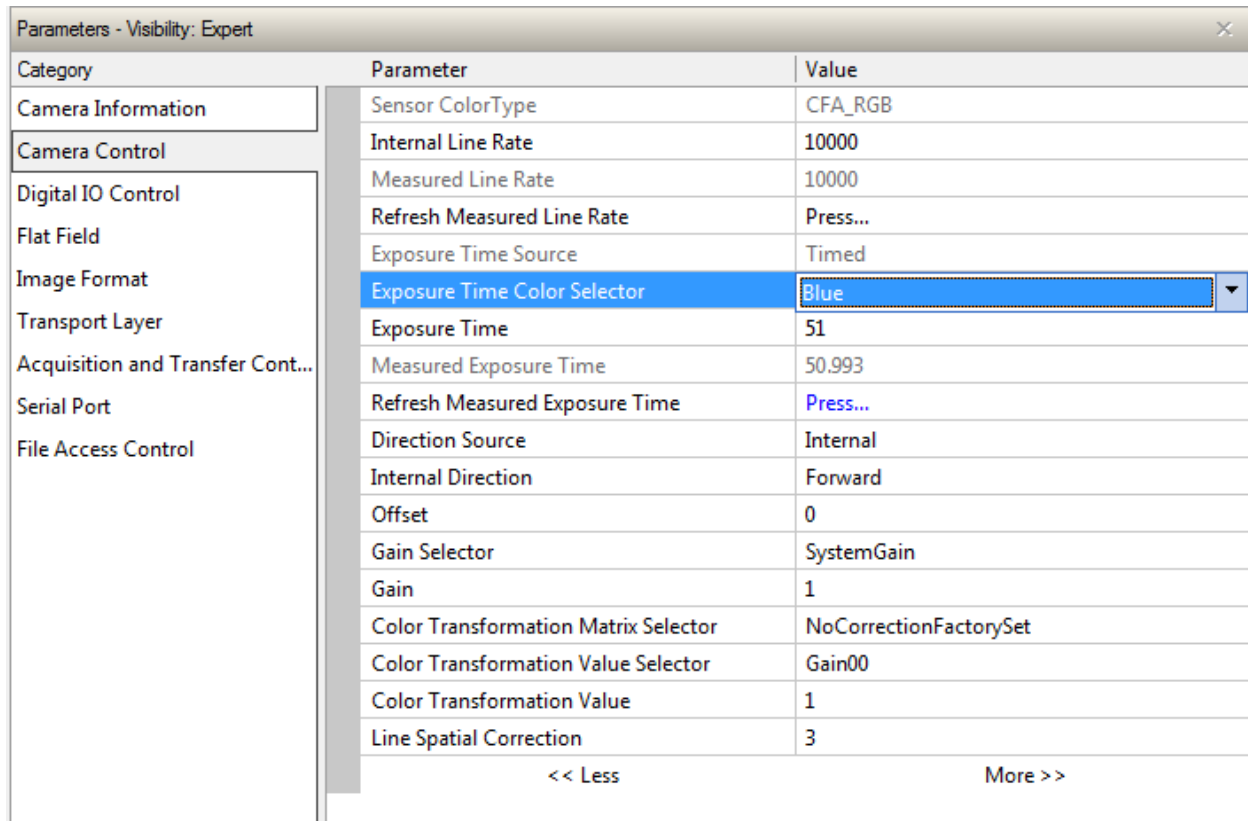

The trilinear cameras feature independent exposure control. This feature allows the user to set a different exposure times for each color. The screenshot above shows the blue color selected. Green and red are selected from the same drop-down box.

Adjust the independent exposure control using either the GUI or the 3-letter commands:

CamExpert GUI

In the Camera Control Set	
Parameter	Value
Exposure Time Color Selector	All, Red, Green, Blue, Mono (2k)
Exposure Time	

Three-Letter Commands

In the Camera Control Set	
Parameter	Value
scl (Select Exposure Time Color Selector)	Select 0-ALL, 1-Red, 2-Green, 3-Blue, 4-Mono (2k).
set (Set Exposure Time)	Executes the command.

Note that the red and green exposure times must be set *at least 1 μ sec shorter than the blue exposure time.*

The above restriction should not be an issue for most applications, as commercial light sources generally output less power at the blue end of the spectrum. If the Exposure Time Color Selector is set to *All*, this criteria is automatically met.

Further note that the order in which the exposure time color selector values are entered is important. When entering the exposure times using either the GenICam interface or the three-letter command interface, checks are performed on the entered exposure times. If a blue integration time is entered that is shorter than the green or red integration time, then an error condition will be indicated and the value will not be accepted by the camera. The same is true if a red or green integration time is entered that is not smaller by 1 μ sec than the blue integration time.

Be aware that the above checking is performed on the value being entered against the values the camera currently has set and therefore that the order that the values are entered is important. For example, if the revised blue value is less than the current blue value, enter the green and red values first. If the new blue value is greater than the current blue value, enter the blue value first.

Digital I/O control feature descriptions

The P4 Digital I/O control category, as organized by CamExpert, groups together the sensor specific parameters. This group includes the controls for line rate, exposure time, scan direction, and gain. Parameters in gray are read-only, either always or due to another parameter being enabled or disabled. Parameters in black are user set in CamExpert or programmable via an imaging application.

Category	Parameter	Value
Board	Trigger Source	CC1
Basic Timing	Trigger Selector	LineStart
Advanced Control	Trigger Mode	Off
External Trigger	<< Less	
Image Buffer and ROI		
Camera - CameraLink_1		
Camera Information		
Camera Control		
Digital IO Control		
Flat Field		
Image Format		
Transport Layer		
Acquisition and Transfer Control		
Serial Port		
File Access Control		

The following table describes the digital I / O control parameters along with their view attributes and the minimum camera firmware version required. Additionally, the firmware column indicates which parameter is a member of the DALSA Features Naming Convention (DFNC), versus the GenICam Standard Features Naming Convention (SFNC not shown). The Device Version number represents the camera software functional group, not a firmware revision number.

Display Name	Feature	Description	Device Version & View
Trigger Source	TriggerSource	Defines the source of external trigger (RO)	1.00 DFNC Beginner
Trigger Selector	TriggerSelector	Defines what the trigger initiates (RO)	1.00 DFNC Beginner
Trigger Mode	TriggerMode	Determines the source of trigger to the camera, internal or external (CC1)	1.00 DFNC Beginner

Flat Field Category

The Flat Field controls, as shown by CamExpert, group parameters used to configure camera pixel format, and image cropping. Additionally a feature control to select and output an internal test image simplifies the process of setting up a camera without a lens.

Parameters in gray are read only, either always or due to another parameter being disabled. Parameters in black are user set in CamExpert or programmable via an imaging application.

Features listed in the description table but tagged as *Invisible* are usually for Teledyne DALSA or third party software usage—not typically needed by end user applications.

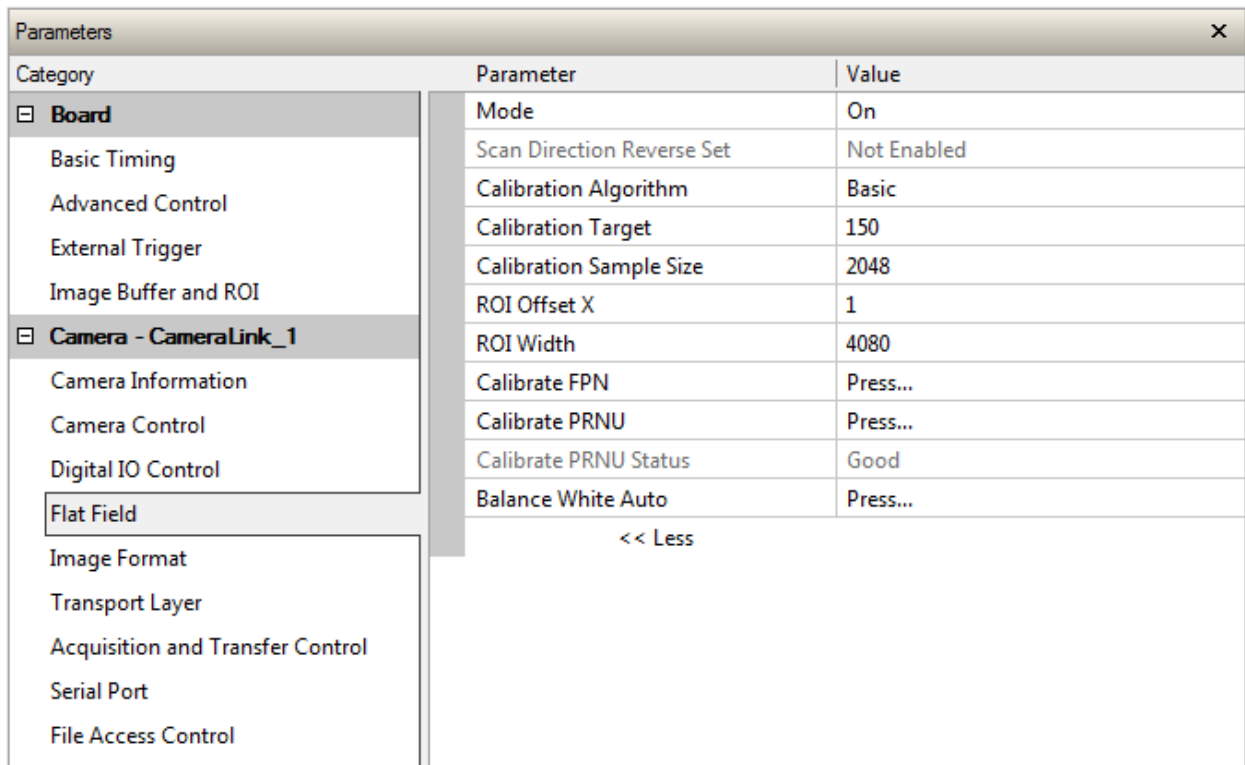

Flat field control feature description

The following table describes these parameters along with their view attribute and minimum camera firmware version required. Additionally the firmware column will indicate which parameter is a member of the DALSA Features Naming Convention (DFNC), versus the GenICam Standard Features Naming Convention (SFNC not shown).

The Device Version number represents the camera software functional group, not a firmware revision number.

Display Name	Feature	Description	Device Version & View
Mode	flatfieldCorrectionMode		1.00

Off	Off	FPN and flat field coefficients disabled.	Beginner
On	On	FPN and flat field coefficients enabled.	DFNC
Initialize	Initialize	Reset all FPN to 0 and all flat field coefficients to 1.	
ScanDirectionControlled	ScanDirectionControlled	Different user set loaded depending on direction.	
Select flatfield Correction Scan Direction Reverse Set	flatfieldScanDirectionReverseSet	When flatfieldCorrectionMode is set to ScanDirectionControlled this feature selects the UserSEt (1 to 8) which will be used for the reverse scan direction.	1.00 Beginner DFNC
Calibration Algorithm	flatfieldCorrectionAlgorithm	Selection between two different flat field algorithms.	1.00 Beginner
Basic	Basic	Direct calculation of coefficients based on average line values and target. First each color is flat fielded to its peak value and then the color gains are used to achieve the target.	DFNC
LowPass	LowPass	A low pass filter is first applied to the average line values before calculating the coefficients. Use this algorithm if the calibration target is not uniformly white or it is not possible to defocus the image. Because of the low pass filter this algorithm is not able to correct pixel-to-pixel variations and so it is preferable to use the "Basic" algorithm.	
Calibration Target	flatfieldCalibrationTarget	Set a value between 0 and 255 to which the flat field algorithm will target the image to.	1.00 Beginner DFNC
Calibration Sample Size	flatfieldCalibrationSampleSize	Sets the number of lines to be averaged during a flat field calibration	1.00 Beginner DFNC
Lines_2048	Lines_2048		
Lines_4096	Lines_4096		
ROI Offset X	flatfieldCalibrationROIOffsetX	Set the starting point of a region of interest where a flat field calibration will be performed	1.00 Beginner DFNC
ROI Width	flatfieldCalibrationROIWidth	Sets the width of the region on interest where a flat field calibration will be performed	1.00 Beginner DFNC

Calibrate FPN	flatfieldCalibrationFPN	Initiates the FPN calibration process	1.00 Beginner DFNC
Calibrate PRNU	flatfieldCalibrationPRNU	Initiates the PRNU or Flatfield process	1.00 Beginner DFNC
Balance White Auto	BalanceWhiteAuto	Initiates the process of balancing the colors to produce a white balance	1.00 Beginner DFNC

Region of Interest (ROI)

The ROI feature is related to flat field calibration. It is important to specify an ROI when the object being imaged has areas that have black, non-illuminated areas such as beyond the edge of a film that is front illuminated, or is saturated, again beyond the edge of a film but in this case bright field back illuminated. The ROI feature allows from one to four specific regions of the pixel line to be specified where flat field calibration will take place. Pixel data outside the ROI will not be used when performing flat field calibration.

Image Format Control Category

The Image Format controls, as shown by CamExpert, groups parameters used to configure camera pixel format, image cropping, and test pattern.

Parameters in gray are read only, either always or due to another parameter being disabled. Parameters in black are user set in CamExpert or programmable via an imaging application.

Features listed in the description table but tagged as *Invisible* are usually for Teledyne DALSA or third party software usage—not typically needed by end user applications.

Parameters ×		
Category	Parameter	Value
Board	Test Pattern	Color_Ramp
Basic Timing	Line Mirroring	Off
Advanced Control	Pixel Format	RGB8
External Trigger	Pixel Coding	Color
Image Buffer and ROI	Pixel Color Filter	None
	Width	4096
	WidthMax	4096
	Height	1
	Multiple AOI Mode	Off
	AOI Count	1
	AOI Selector	1
	AOI Offset X	1
	AOI Width	4096
	<< Less	
Camera - CameraLink_1		
Camera Information		
Camera Control		
Digital IO Control		
Flat Field		
Image Format		
Transport Layer		
Acquisition and Transfer Control		
Serial Port		
File Access Control		

Image format control feature description

The following table describes these parameters along with their view attribute and minimum camera firmware version required. Additionally the firmware column will indicate which parameter is a member of the DALSA Features Naming Convention (DFNC), versus the GenICam Standard Features Naming Convention (SFNC not shown).

The Device Version number represents the camera software functional group, not a firmware revision number.

Display Name	Feature	Description	Device Version & View
Test Pattern	TestImageSelector	Selects the type of test image that is sent by the camera. Choices are either as defined by SNFC and/or as provided by the device manufacturer.	1.00 Beginner DFNC
Off	Off	Selects sensor video to be output from sensor	
Ramp Color_Ramp	Ramp Color_Ramp	Selects a grey scale Selects a color ramp	
Line Mirroring	ReverseX		1.00
Off	Off	Video output in normal order	Beginner
On	On	Video output in a reverse order	DFNC
Pixel Format	PixelFormat	Output image pixel coding format of the sensor.	1.00 Beginner DFNC
RGB8	RGB8	RGB 8bit	
RGB10	RGB10	RGB 10bit	
RGB12	RGB12	RGB 12bit	
BGR8	BGR8	BGR 8bit	
BGR10	BGR10	BGR 10bit	
BGR12	BGR12	BGR 12bit	
RGB8+mono8	RGB8+mono8	RGB 8bit plus mono 8 bit	
BGR8+mono8	BGR8+mono8	BGR 8bit plus mono 8 bit	
RGB12+mono12	RGB12+mono12	RGB 12bit plus mono 12 bit	
BGR12+mono12	BGR12+mono12	BGR 12bit plus mono 12 bit	
Pixel Color Filter	PixelColorFilter	Indicates the type of color filter applied to the image. (RO)	1.00 Beginner DFNC
Pixel Coding	PixelCoding	(RO)	1.00 Beginner DFNC
Width	Width	Width of the Image provided by the device (in pixels).(RO)	1.00 Beginner DFNC

Max Width	WidthMax	The maximum image horizontal dimension of the image. (RO)	1.00 Beginner
Height	Height	Height of the Image provided by the device (in lines). (RO)	1.00 Beginner
Multiple AOI Mode Off Active	multipleAOIMode Off Active	Turns on an output Area of Interest Area of interest is off Area of interest is on	1.00 Beginner
Multiple AOI Count	multipleAOICount	Set the number of output area of interest 1-4	1.00 Beginner DFNC
Multiple AOI Selector	multipleAOISelector	Selects the area of interest to be setup	1.00 Beginner DFNC
AOI Offset X	multipleAOIOffsetX	Set the start of area of interest (pixels)	1.00 Beginner DFNC
AOI Width	multipleAOIWidth	Set the width of area of interest (pixels)	1.00 Beginner
Horizontal Binning 1 2	BinningHorizontal 1 2	Selects between 1x or 2x horizontally binned image	1.00 Beginner DFNC

Area of Interest (AOI) Setup

The Area of Interest (AOI) feature can be used to reduce the amount of image-data output from the camera. Use this feature when there are areas in the image that contain unneeded information.

An example where you would use this feature is in an application that is inspecting several separated lanes of objects with one camera and the image between the lanes can be ignored.

The AOI feature allows from one to four specific areas of the pixel line to be specified where image data will be output. Since the AOI feature reduces the amount of data output, this has the additional benefit of allowing the cameras to operate at higher EXSYNC rates when using base, medium, or full camera link modes.

For example, if the total number of pixels for the specified AOI's is less than 1 K when using base Camera Link mode at 85 MHz, the maximum EXSYNC rate can be 70 KHz; versus 20 KHz if all 4 K pixels were output.

Note: The setup of AOI is always with respect to the sensor. Therefore, if you are using the mirroring mode with AOI, be aware that pixel one will be on the right side of the displayed image.

In order to set up an AOI for the camera:

1. The AOI mode must first be in the off position.
2. Use the AOI Count to select the total number of AOIs desired to a max of 4.
3. To set up each AOI individual use the AOI Selector to point to the AOI to be set up.
4. AOI Offset X is used indicate the starting pixel of the AOI.
5. AOI Width is used to indicate the width of the that AOI.

The screenshot shows a 'Parameters' window with a tree view on the left and a table of parameters on the right. The 'Camera - Camera' category is selected. The table lists parameters such as 'Multiple AOI Mode', 'AOI Count', 'AOI Selector', 'AOI Offset X', and 'AOI Width'. Five callout boxes provide instructions for setting up AOI: 1. 'Multiple AOI Mode' must be off; 2. 'AOI Count' should be set to 4; 3. 'AOI Selector' should be set to 1; 4. 'AOI Offset X' should be set to 1; 5. 'AOI Width' should be set to 4096.

Category	Parameter	Value
Camera - Camera	Test Pattern	Color_Ramp
	Line Mirroring	Off
	Pixel Format	RGB8
		Color
		None
	Width	4096
	WidthMax	4096
	Height	1
	Multiple AOI Mode	Off
	AOI Count	1
AOI Selector	1	
AOI Offset X	1	
AOI Width	4096	
<< Less		

In order to initiate operation of the AOI once setup:

1. The AOI mode must be changed to Active.
2. Be sure to set the frame grabber image width to the sum of all AOI widths set up in the camera.

The screenshot shows a 'Parameters' dialog box with a tree view on the left and a table of parameters on the right. The 'Image Format' category is selected in the tree view. The table lists various parameters and their current values. A callout box points to the 'Width' parameter, which is set to 4096.

Category	Parameter	Value
Board	Test Pattern	Color_Ran
	Line Mirroring	Off
	Pixel Format	RGB8
	Pixel Coding	Color
	Pixel Color Filter	None
	Width	4096
	WidthMax	4096
	Height	1
	Multiple AOI Mode	Off
	AOI Count	1
Camera - CameraLink_1	AOI Selector	1
	AOI Offset X	1
	AOI Width	4096
	<< Less	
	Camera Information	
	Camera Control	
	Digital IO Control	
	Flat Field	
	Image Format	
	Transport Layer	
Acquisition and Transfer Control		
Serial Port		
File Access Control		

Instructions on using the camera scan direction to control camera parameters

The camera is capable of adjusting camera parameters on-the-fly based on the scan direction of the camera. These parameters include gain, flat field coefficients, white balance and exposure time.

1. The first step is to put the camera in the reverse direction. This can be done using a reverse signal through CC3 and the Direction Source set to external or by having the Direction Source set to Internal and the Internal Direction set to reverse.
2. Set up all the desired parameters, including flat field corrections.

The screenshot shows a 'Parameters' window with a tree view on the left and a table of parameters on the right. The 'Camera - CameraLink_1' category is selected, and 'Camera Control' is expanded. In the table, the 'Internal Direction' parameter is highlighted, and its dropdown menu is open, showing 'Reverse' selected. A callout box points to the dropdown with the text: 'First, setup parameters for reverse direction.'

Category	Parameter	Value	
Board	Sensor ColorType	CFA_RGB	
	Internal Line Rate	10000	
	Measured Line Rate	10000	
	Refresh Measured Line Rate	Press...	
	Exposure Time Source	Timed	
	Exposure Time Color Selector	All	
	Camera - CameraLink_1	Exposure Time	50
		Measured Exposure Time	50.99
		Refresh Measured Exposure Time	Press...
		Direction Source	Internal
Internal Direction		Reverse	
Offset		0	
Gain Selector		SystemGain	
Gain		1	
Color Transformation Matrix Selector		NoCorrectionFactorySet	
Color Transformation Value Selector		Gain00	
Color Transformation Value	1		
Line Spatial Correction	3		

3. Save the camera parameters to a User set other than the default user set.

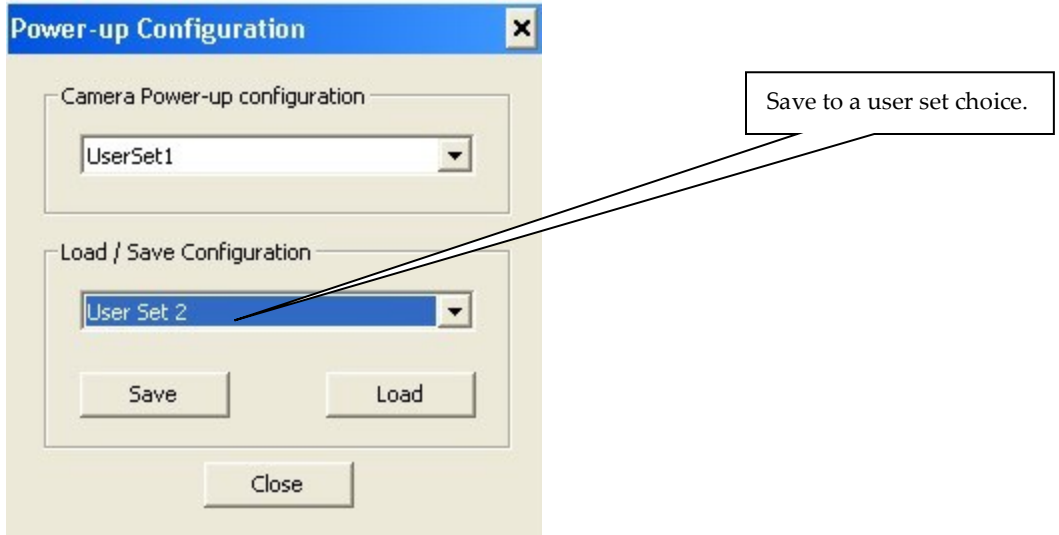

4. The next step is to put the camera in the forward direction. This can be done using a forward signal through CC3 and the Direction Source set to external or by having the Direction Source set to Internal and the Internal Direction set to forward.
5. Set up all the desired parameters including doing a flat field.

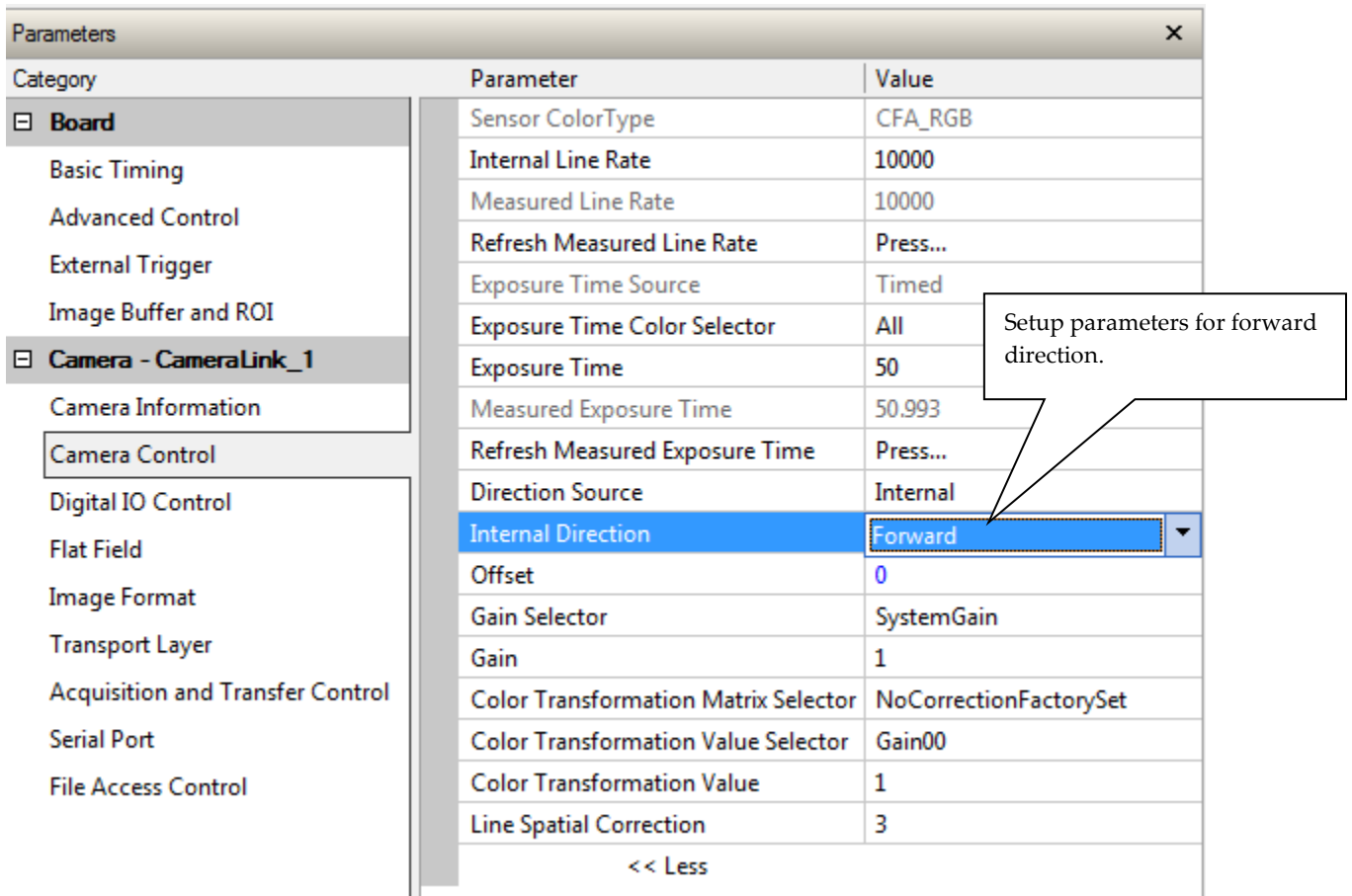

- Save the camera set to User Set other than the saved to for the reverse direction. The forward direction user set and the default user set must be the same.

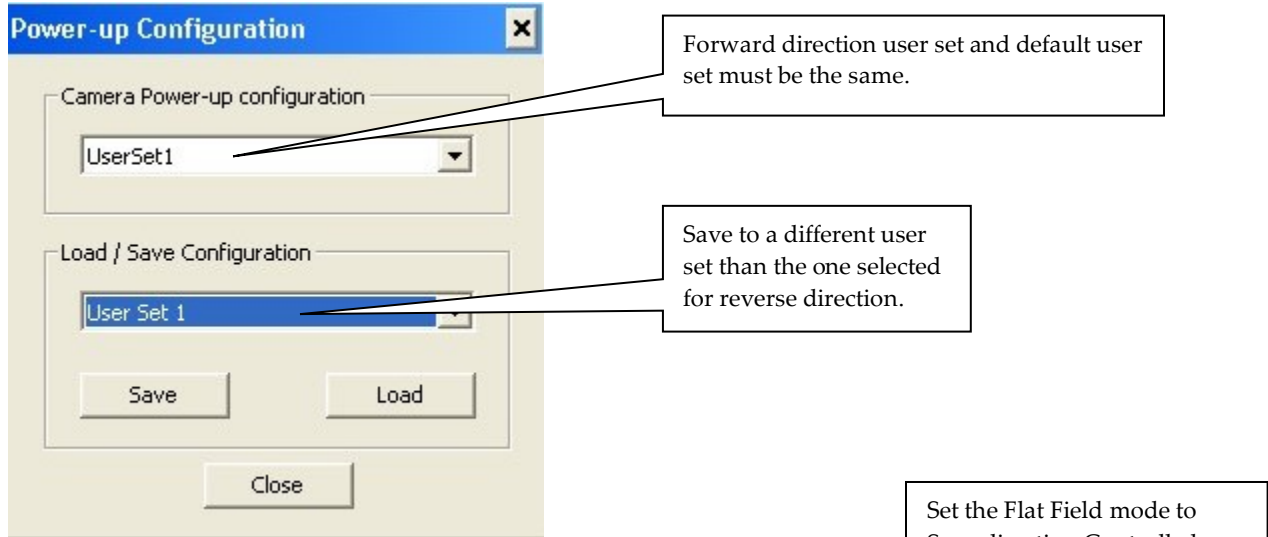

- In the Flat Field area change the mode to Scan Direction Controlled.

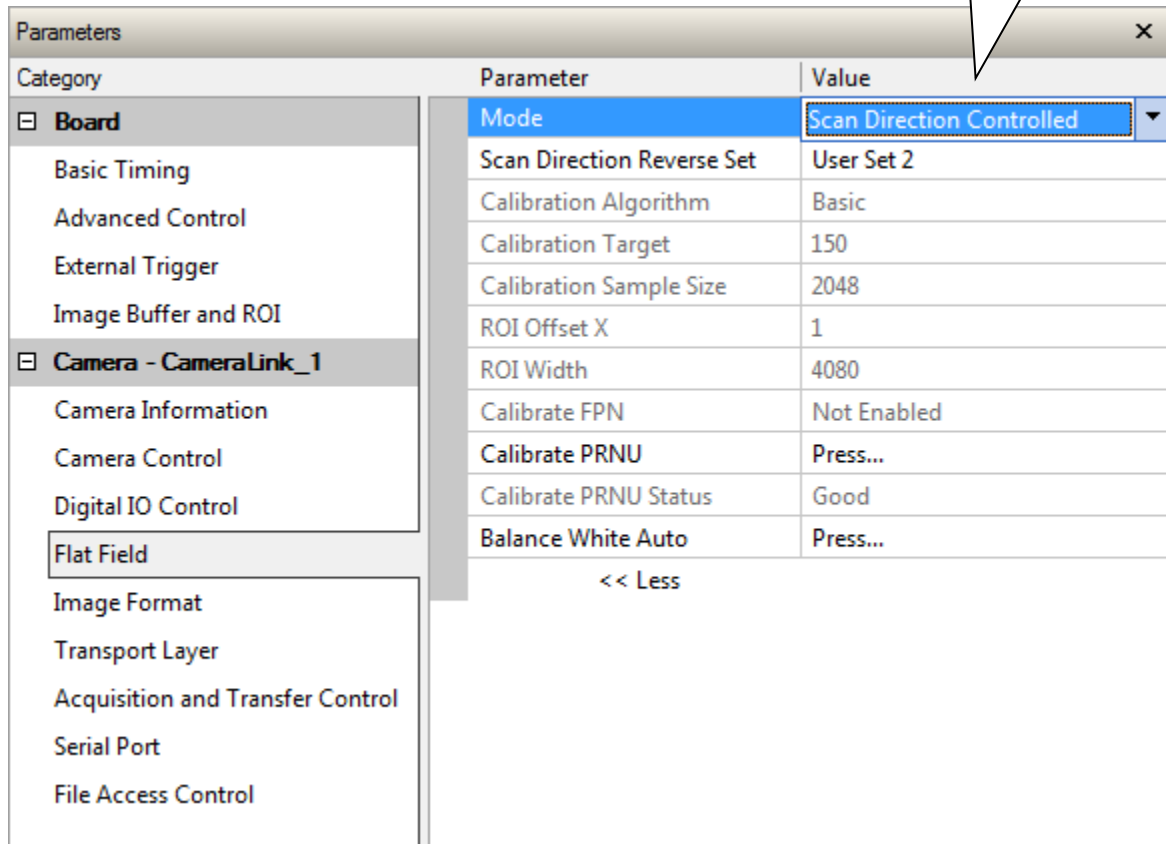

A Note on External Direction, Direction Source, and User Sets

If using external direction control through CC3 ensure that the Direction Source is both set to external and saved in the user set. Also ensure that the polarity on CC3 is set appropriately for the desired direction.

Transport Layer Control Category

Parameters in gray are read only, either always or due to another parameter being disabled. Parameters in black are user set in CamExpert or programmable via an imaging application.

Features listed in the description table but tagged as *Invisible* are usually for Teledyne DALSA or third party software usage—not typically needed by end user applications.

Parameters ✕		
Category	Parameter	Value
Board	Restart Camera	Press...
Basic Timing	XML Major Version	0
Advanced Control	XML Minor Version	0
External Trigger	Refresh GenCP Status	Press...
Image Buffer and ROI	Last GenCP Status	0
Camera - CameraLink_1	CameraLink Clock Frequency	CL85MHz
Camera Information	Camera Link Configuration	Medium
Camera Control	Tap Geometry	Geometry_1X6
Digital IO Control	<< Less	
Flat Field		
Image Format		
Transport Layer		
Acquisition and Transfer Control		
Serial Port		
File Access Control		

Transport Layer feature descriptions

The following table describes these parameters along with their view attribute and minimum camera firmware version required. Additionally the firmware column will indicate which parameter is a member of the DALSA Features Naming Convention (DFNC), versus the GenICam Standard Features Naming Convention (SFNC not shown).

Display Name	Feature	Description	Device Version & View
Restart Camera	DeviceReset	Used to restart the camera, warm reset	1.00 Beginner DFNC
XML Major Version	DeviceManifestXMLMajorVersion	Together with DeviceManifestXMLMinorVersion specifies the GenICam™ feature description XML file version (RO)	1.00 Beginner DFNC
XML Minor Version	DeviceManifestXMLMinorVersion	Together with DeviceManifestXMLMajorVersion specifies the GenICam™ feature description XML file version (RO)	1.00 Beginner DFNC
Last GenCP Status	genCPStatus	If a feature read or write fails then Sopera only returns that it fails – read this feature to get the actual reason for the failure Returns the last error Reading this feature clears it	1.00 Beginner DFNC
Refresh GenCP Status	refreshGenCPStatus	Press to return the current status of the GenCP	1.00 Beginner
Camera Link Configuration	CIConfiguration Base Medium Full Deca	Camera Link Output configuration	1.00 Beginner
Camera Link Configuration	clDeviceClockFrequency CL85MHz CL66MHz	Set the camera link clock rate	1.00 Beginner
Tap Geometry	DeviceTapGeometry	(RO)	1.00 Beginner

Acquisition and Transfer Control Category

The P4 Acquisition and Transfer controls, as shown by CamExpert, group parameters used to configure the optional acquisition modes of the device. Parameters in gray are read only, either always or due to another parameter being disabled. Parameters in black are user set in CamExpert or programmable via an imaging application.

Features listed in the description table but tagged as *Invisible* are usually for Teledyne DALSA or third party software usage—not typically needed by end user applications.

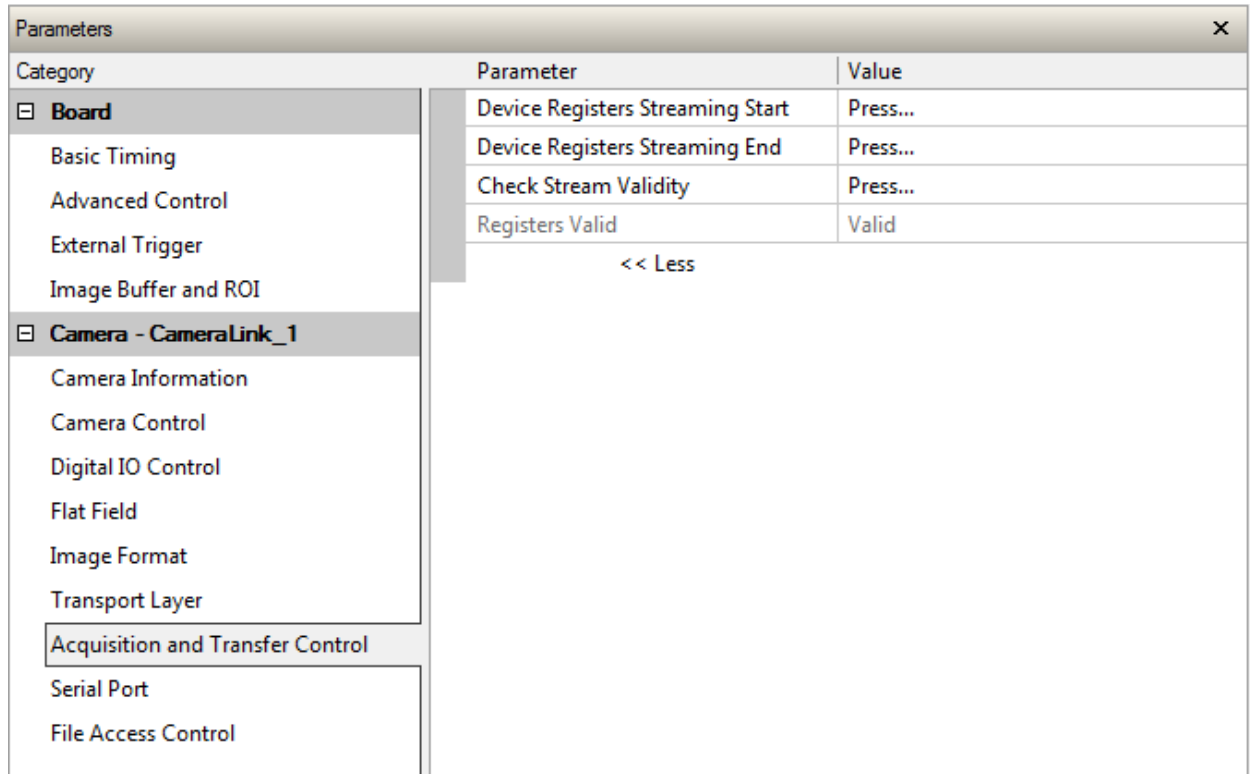

Acquisition and Transfer Control feature descriptions

The following table describes these parameters along with their view attribute and minimum camera firmware version required. Additionally the firmware column will indicate which parameter is a member of the DALSA Features Naming Convention (DFNC), versus the GenICam Standard Features Naming Convention (SFNC not shown).

Display Name	Feature	Description	Device Version & View
Device Registers Streaming Start	DeviceRegistersStreamingStart	Announces the start of registers streaming without immediate checking for consistency.	1.00 Beginner DFNC

Device Registers Streaming End	DeviceRegistersStreamingEnd	Announces end of registers streaming and performs validation for registers consistency before activating them.	1.00 Beginner DFNC
Check Stream Validity	DeviceRegistersCheck	Press to check the validity of the current register set.	1.00 Beginner DFNC
Registers Valid	DeviceRegistersValid	States if the current register set is valid and consistent.	1.00 Beginner DFNC

Serial Port Control Category

The Serial Port control in CamExpert allows the user to select an available camera serial port and review its settings.

Features listed in the description table but tagged as *Invisible* are usually for Teledyne DALSA or third party software usage—not typically needed by end user applications.

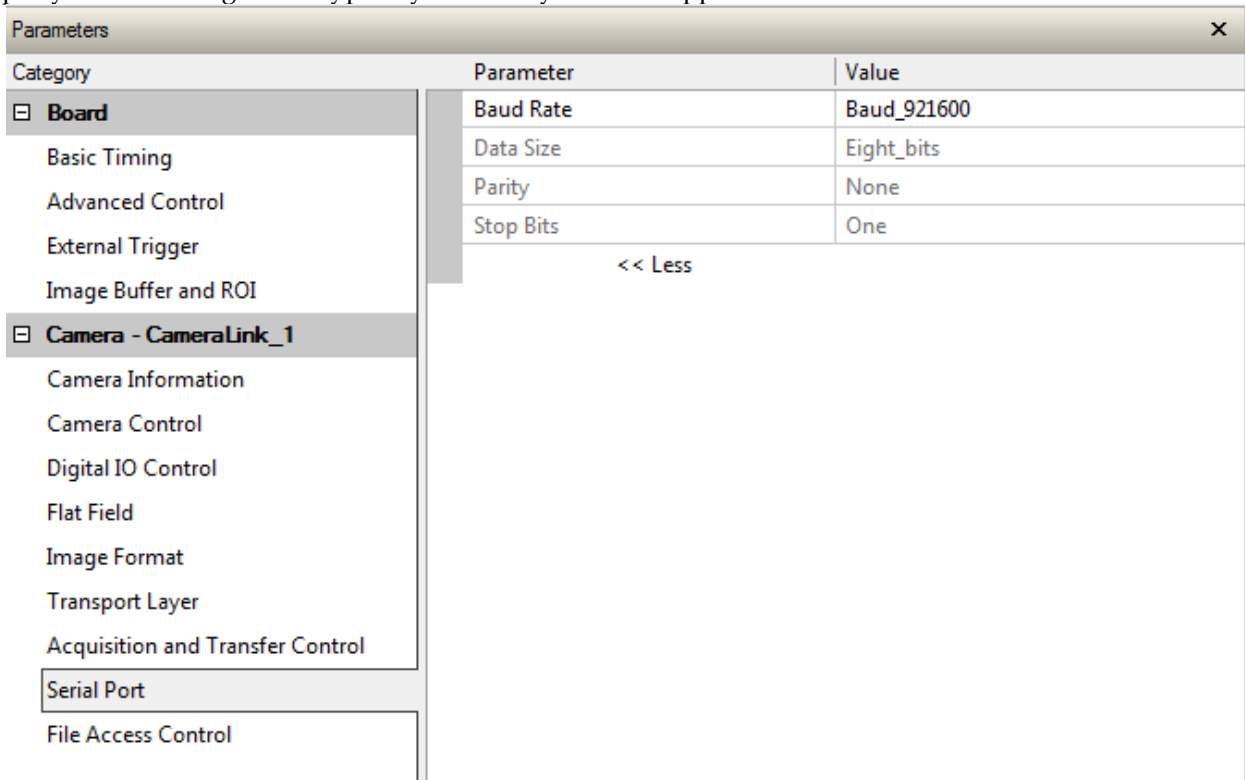

Serial Port control feature descriptions

The Device Version number represents the camera software functional group, not a firmware revision number.

Display Name	Feature	Description	View
Baud Rate	DeviceSerialPortBaudRate	Sets the baud rate used by the selected device's serial port. Available baud rates are device-specific.	1.00 Beginner DFNC
Baud 9600	Baud 9600	Baud rate is 9600	
Baud 19200	Baud 19200	Baud rate is 19200	
Baud 57600	Baud 57600	Baud rate is 57600	
Baud 115200	Baud 115200	Baud rate is 115200	
Baud 230400	Baud 230400	Baud rate is 230400	
Baud 460800	Baud 460800	Baud rate is 460800	
Serial Port Parity	deviceSerialPortParity	Sets the parity checking type on the selected serial port.(RO)	1.00 Beginner DFNC
None	None	Parity checking is disabled	
Data Size	deviceSerialPortDataSize	Sets the bits per character (bpc) to use (RO).	1.00
Eight Bits	bpc8	Use 8 bits per character	Beginner DFNC
Stop Bits	deviceSerialPortNumberOf StopBits	Sets the number of stop bits to use.	1.00 Beginner
Stopbits1	Stopbits1	Use 1 stop bit	DFNC

File Access Control Category

The File Access control in CamExpert allows the user to quickly upload various data files to the connected camera. The supported data files are for firmware updates, flat field coefficients, LUT data tables, and a custom image for use as an internal test pattern.

Features listed in the description table but tagged as *Invisible* are usually for Teledyne DALSA or third party software usage—not typically needed by end user applications.

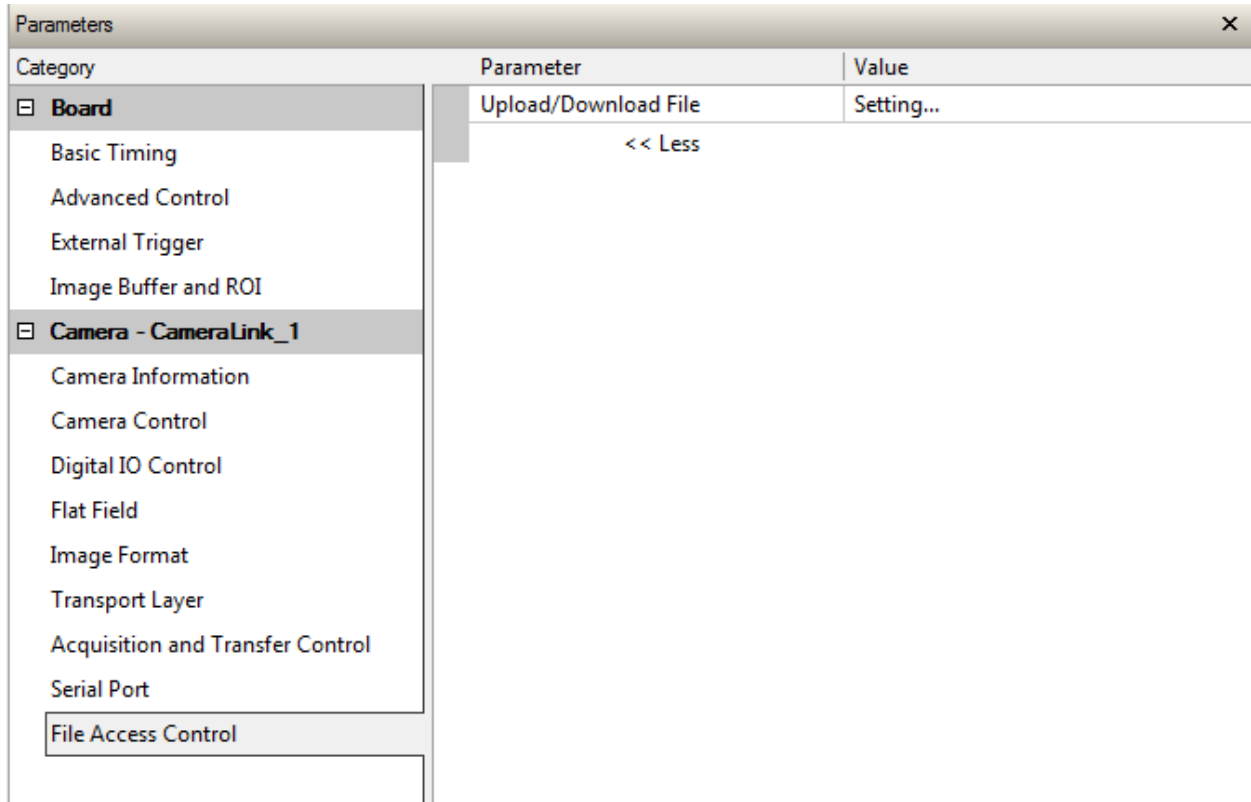

File Access Control feature descriptions

Display Name	Feature	Description	View
File Selector	FileSelector	Selects the file to access. The file types which are accessible are device-dependent.	1.00 Beginner
FPGA Code	Firmware1	Upload new FPGA to the camera which will execute on the next camera reboot cycle.	DFNC
Micro Code		Upload new micro code to the camera which will execute on the next camera reboot cycle.	
CCI		Upload new CCI to the camera which will execute on the next camera reboot cycle.	
XML		Upload new XML to the camera which will execute on the next camera reboot cycle.	
User Set		Use UserSetSelector to specify which user set to access.	
Factory FlatField coefficients		Use UserSetSelector to specify which user flatfield to access.	
User FPN		Use UserSetSelector to specify which user FPN to access.	
ColorCorrectionMatrix		Upload new color correction matrix to the camera.	
CameraData		Download camera information and send for customer support.	
File Operation Selector	FileOperationSelector	Selects the target operation for the selected file in the device. This operation is executed when the File Operation Execute feature is called.	1.00 Guru
Open	Open	Select the Open operation - executed by FileOperationExecute.	
Close	Close	Select the Close operation - executed by FileOperationExecute.	
Read	Read	Select the Read operation - executed by FileOperationExecute.	
Write	Write	Select the Write operation - executed by FileOperationExecute.	
Delete	Delete	Select the Delete operation - executed by FileOperationExecute.	
File Operation Execute	FileOperationExecute	Executes the operation selected by File Operation Selector on the selected file.	1.00 Guru
File Open Mode	FileOpenMode	Selects the access mode used to open a file on the device.	1.00 Guru
Read	Read	Select READ only open mode	
Write	Write	Select WRITE only open mode	
File Access Buffer	FileAccessBuffer	Defines the intermediate access buffer that allows the exchange of data between the device file storage and the application.	1.00 Guru

File Access Offset	FileAccessOffset	Controls the mapping offset between the device file storage and the file access buffer.	1.00 Guru
File Access Length	FileAccessLength	Controls the mapping length between the device file storage and the file access buffer.	1.00 Guru
File Operation Status	FileOperationStatus	Displays the file operation execution status. (RO).	1.00 Guru
Success	Success	The last file operation has completed successfully.	
Failure	Failure	The last file operation has completed unsuccessfully for an unknown reason.	
File Unavailable	FileUnavailable	The last file operation has completed unsuccessfully because the file is currently unavailable.	
File Invalid	FileInvalid	The last file operation has completed unsuccessfully because the selected file is not present in this camera model.	
File Operation Result	FileOperationResult	Displays the file operation result. For Read or Write operations, the number of successfully read/written bytes is returned. (RO)	1.00 Guru
File Size	FileSize	Represents the size of the selected file in bytes.	1.00 Guru

File Access via the CamExpert tool

1. Click on the "Setting..." button to show the file selection menu.

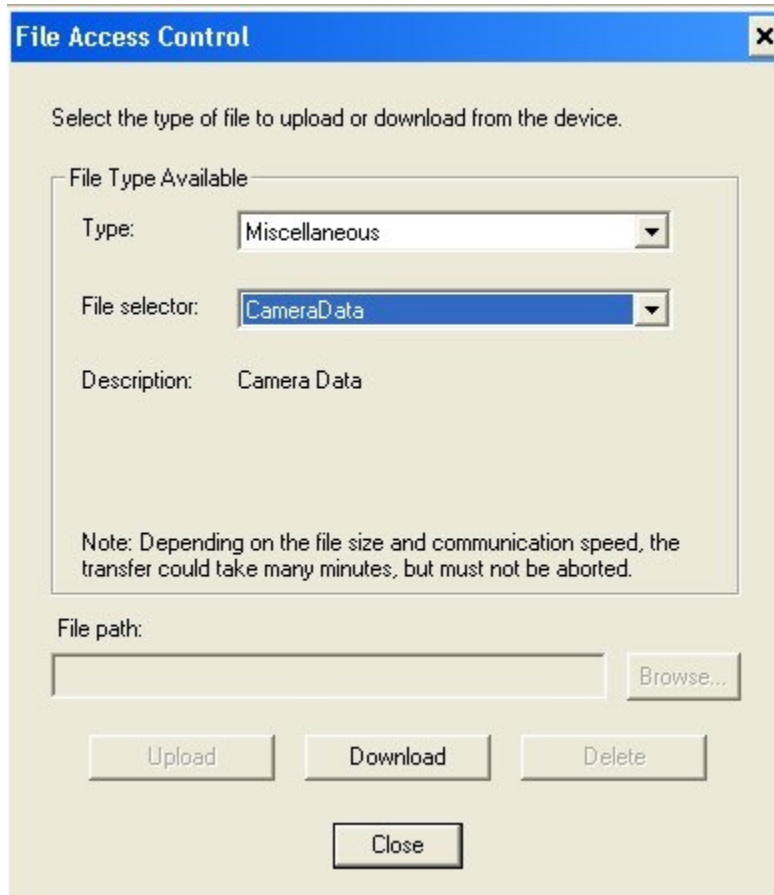

2. From the Type drop menu, select the file type that will be uploaded to the camera.
3. From the File Selector drop menu, select the camera memory location for the uploaded data. This menu presents only the applicable data locations for the selected file type.
4. Click the Browse button to open a typical Windows Explorer window.
5. Select the specific file from the system drive or from a network location.
6. Click the Upload button to execute the file transfer to the camera.
7. Note that firmware changes require a device reset command from the Camera Information Controls and, additionally, CamExpert should be shut down and restarted after a reset.

Download a list of camera parameters

For diagnostic purposes you may want to download a list of all the parameters and values associated with the camera.

1. Go to File Access Control
2. Click on Settings
3. In the "Type" drop down box select "Miscellaneous."
4. In the "File selector" drop down box select "CameraData."

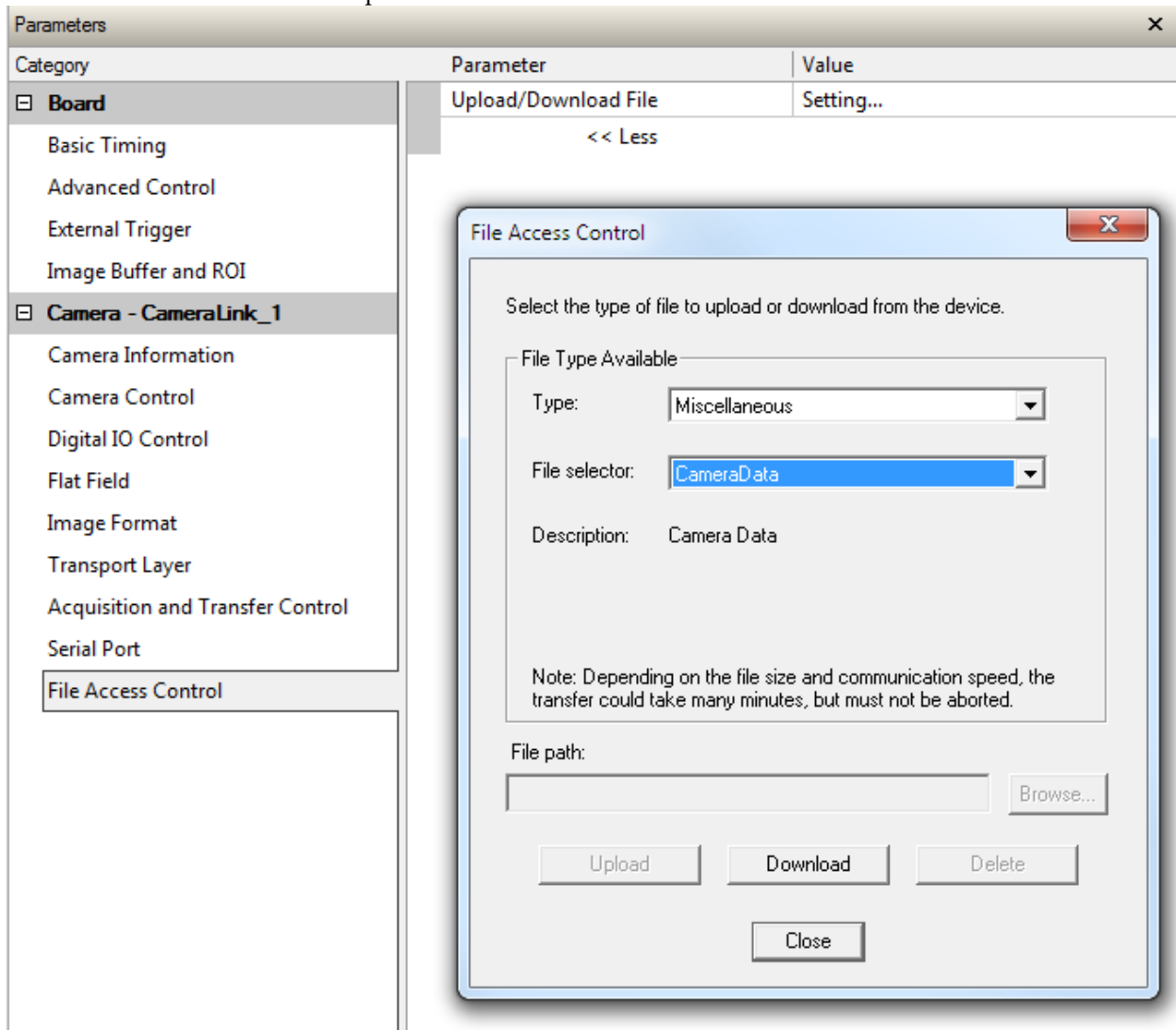

5. Hit "Download"
6. Save the text file and send the file to Teledyne DALSA customer support.

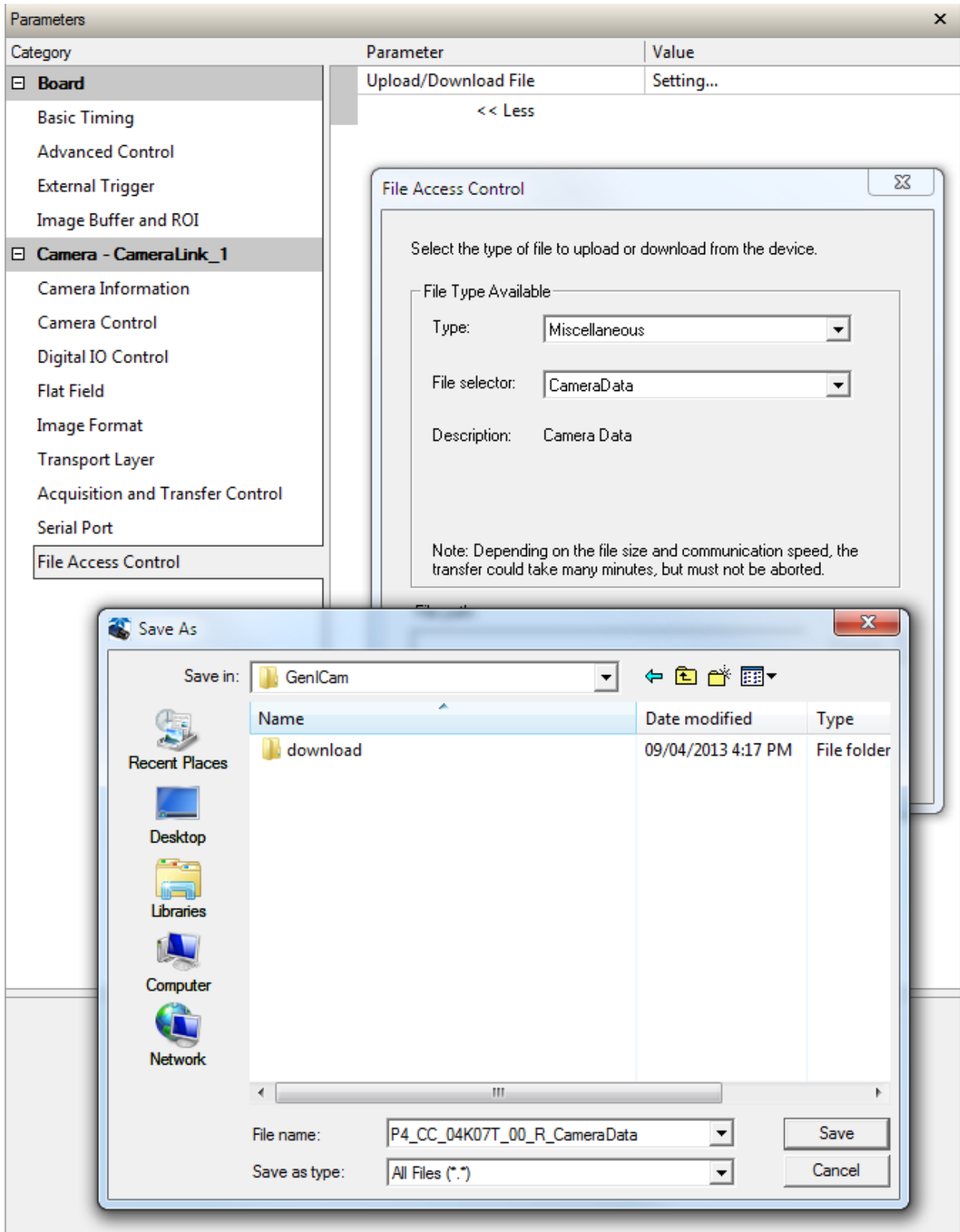

Appendix B: ASCII Commands

The following commands can be used to control the Teledyne DALSA Piranha4 cameras.

Accessing the Three Letter Commands (TLC)

To access the TLC an ASCII-based communications interface application, such as HyperTerminal.

Additionally it is possible to use the functions of `clserxxx.dll` or `clallserial.dll` as defined in the Camera Link Specification.

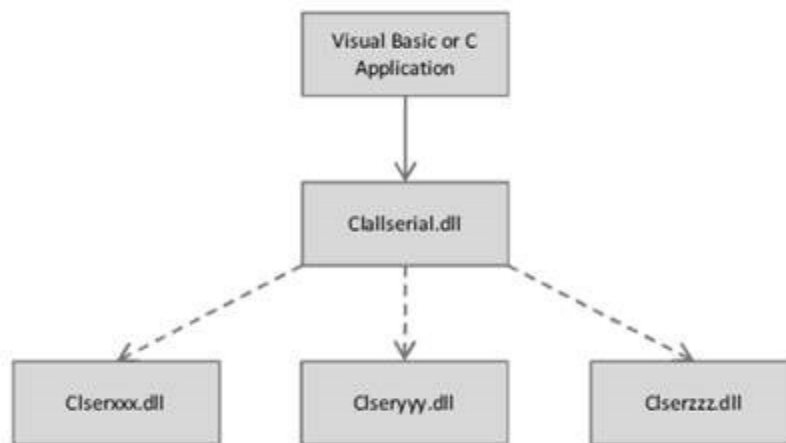

Figure 36: Serial DLL hierarchy as mentioned in the Camera Link Specification

1. Cycle power to the camera: by either a) issuing the reset camera command (rc), or b) powering the camera OFF and then ON.
2. Load the ASCII interface using:
 - 9600 baud
 - 8 data bits
 - no parity
 - 1 stop bit
 - no flow control
 - local echo
 - (carriage return / linefeed)
3. Wait for a stable status LED color (green or red) before proceeding. Note that all entries in HyperTerminal will be ignored until a stable LED color is obtained.
4. In case of HyperTerminal, press the <ESC> key.
5. Once <ESC> has been entered the help screen appears.

Notes on Using Alternatives to HyperTerminal

- If you are using interfaces other than HyperTerminal, the ASCII character, ESC, is decimal 27 and needs to be issued. From the command line insert ESC by using ALT+2+7 of the activated Num-Pad. In some cases this needs to be followed by a carriage return or a linefeed to send this to the camera.
- In ASCII the ESC character may look like this: “←”.

ASCII to GenCP

To switch from the ASCII-command interface to the GenCP interface, the camera must be either reset (RC) or the power must be cycled. Note that GenCP and ASCII commands cannot be accessed simultaneously.

Note that the HyperTerminal application is not available on the Windows 7 OS.

Alternatives to HyperTerminal

The following alternative ASCII-interfaces have been tested and shown to work with this camera: PuTTY and TeraTerm. Note that PuTTY does not have Xmodem capability while TeraTerm does. Xmodem is required to update code in the camera.

The camera responds to a simple ASCII-based protocol. A carriage return <CR> ends each command.

Example: to return the current detector settings

```
gcp <CR>
```

A complete list of the available detector commands, their format and parameters can be displayed by sending the help (h) command.

Port configuration

Baud: 9,600
 Bits: 8
 Parity: None
 Stop bits: 1
 Flow Control: None

Echo typed characters locally.

Rules

- The interface is not case sensitive
- One command and argument(s) per line
- To enter a floating point number prefix it with a “F” – for example “ssg 0 f1.5”
- Error codes returned are the same as the GenICam™ interface – see Diagnostics | Error Codes
- Follow each command with the carriage return character – 0x0D

Commands

Full Name	Balance White Auto	
Mnemonic	BWA	
Argument(s)		
Description	Perform automatic white balance	
Notes	<ul style="list-style-type: none"> Gain each color such that the average of each is at the same level as the average of the most responsive. 	

Full Name	Calibrate User FPN	
Mnemonic	CCF	
Argument(s)	# of lines to average	<ul style="list-style-type: none"> 2048 4096
Description	Calibrate user FPN dark flat field coefficients.	

Full Name	Camera Link Speed	
Mnemonic	CLS	
Argument(s)	Frequency	<ul style="list-style-type: none"> 0. 85 MHz 1. 66 MHz
Description	Camera Link clock frequency	

Full Name	Camera Link Mode	
Mnemonic	CLM	
Argument(s)	Mode	<ul style="list-style-type: none"> 0. Base 1. Medium 2. Full 3. Deca 4. Dual Base
Description	Camera Link Mode	

Full Name	Color Matrix Selector	
Mnemonic	CMS	
Argument(s)	Device	<ul style="list-style-type: none"> 0. Factory 1. User
	# of lines to average	<ul style="list-style-type: none"> 0 or 1, when factory selected above then 2. White LED 3. No correction (unity matrix)
Description	Color matrix selector	

Full Name	Calibrate Flatfield	
Mnemonic	CPA	
Argument(s)	Algorithm	0. Basic 1. Low-pass filter
	# of lines to average	<ul style="list-style-type: none"> • 2048 • 4096
	Target	0 to 255
Description	Calibrate user PRNU flat field coefficients	
Notes	<ul style="list-style-type: none"> • Coefficients are saved and loaded with user set (e.g. USS / USL) • Basic algorithm flattens each color and then uses color gains to achieve target • Whereas low-pass filter algorithm does not adjust color gains 	

Full Name	Color Transformation Value	
Mnemonic	CTV	
Argument(s)	Selector	0. C _r gain 1. C _g gain 2. C _b gain 3. C _g gain 4. C _g gain 5. C _g gain 6. C _r gain 7. C _g gain 8. C _b gain 9. k _r offset 10. k _g offset 11. k _b offset
	Floating Point Value	<ul style="list-style-type: none"> • Gains: -16 to +16 • Offsets: 0 to 255
Description	Color Transformation Matrix	
Notes	<ul style="list-style-type: none"> • Value must be immediately preceded with a "F" (e.g. <code>ctv 0 f1.5</code>) 	

Full Name		
Mnemonic	FCS	
Argument(s)	File selector	<ul style="list-style-type: none"> 0. User Set 1. User PRNU 3. FPGA 4. Microcode 5. CCI 6. XML 15. User FPN 16. Color correction matrix
Description	<ul style="list-style-type: none"> • Upload file to camera using Xmodem protocol (HyperTerminal) • User set, PRNU, FPN, and color correction matrix are saved in the currently active set • Location to save color correction matrix is specified with CMS command 	
Notes	<ul style="list-style-type: none"> 1. Enter "FCS <#>" command from HyperTerminal 2. Click on "Transfer" 3. Browse and find file 4. Select "Xmodem" protocol 5. Click "Send" 6. When it indicates that it is done click "Close" 7. Upload all files and then reset camera 	

Full Name	Flatfield Mode	
Mnemonic	FFM	
Argument(s)	Mode	<ul style="list-style-type: none"> 0. Disable use of user FPN and PRNU flat field correction coefficients 1. Enable use of user FPN and PRNU flat field correction coefficients 2. Reset user FPN coefficients to zero and user PRNU coefficients to one 3. Scan direction controlled user set loading
Description	Set flat field mode	
Notes		

Full Name	Set Flatfield Scan Direction Reverse Set	
Mnemonic	FRS	
Argument(s)	User Set Number	1 to 8
Description	Set scan direction controlled reverse set	
Notes		

Full Name	Display Camera Configuration
Mnemonic	GCP
Argument(s)	
Description	Display current value of camera configuration parameters
Notes	<pre> USER>gcp Model P4_CC_02K07Q_00_R Microcode 03-081-20294-92 CCI 03-110-20300-93 FPGA 03-056-20457-99 Serial # 19620110 User ID BiST: Good DefaultSet 1 Ext Trig Off Line Rate 10000 [Hz] Meas L.R. 10000 [Hz] Max L.R. 19047 [Hz] Exp. Mode Timed Exp. Red Time 49000 [ns] Exp. Gr. Time 50000 [ns] Exp. Bl. Time 51000 [ns] Exp. Mono Time 5000 [ns] Meas E.T. 51000 [ns] Max E.T. 98500 [ns] Test Pat. 0:Off Direction Internal, Forward Line Delay 2.00 Flat Field Off Color Plane Selector: All Offset 0 System Gain 1.00 Red Gain 1.00 Green Gain 1.00 Blue Gain 1.00 Mono Gain 1.00 Color Matrix Selector: Factory 2 Color Correction Matrix: 1.000000, 0.000000, 0.000000, 0 0.000000, 1.000000, 0.000000, 0 0.000000, 0.000000, 1.000000, 0 Mirror Off AOI Mode: Off CL Speed 85MHz CL Config Dual Base Pixel Fmt RGB8 CPA ROI 1-2048 USER> </pre>

Full Name	Get Value
Mnemonic	GET
Argument(s)	<parameter>
Description	The "get" command displays the current value(s) of the feature specified in the string

	parameter. Note that the parameter is preceded by a single quote "'". Using this command will be easier for control software than parsing the output from the "gcp" command.	
Notes	<pre>User>get `ssf 10000 Short Full Name Displayed Value and Description bwa Balance white auto No value returned ccf Calibrate User FPN No value returned cls Camera Link Speed 0: 85MHz or 1: 66 MHz clm Camera Link Mode 0: Base 1: Med 2: Full 3: Deca cms Color matrix 0: Factory1, 1: Factory2, 2: User1, 3: User2 cpa Calibrate Flatfield No value returned ctv Color Transformation Value 12 lines, floating point values Gain 00 Gain 01 Gain 02 Gain 10 Gain 11 Gain 12 Gain 20 Gain 21 Gain 22 Offset 1 Offset 2 Offset 3 ffm Flat Field Mode 0: Off, 1: On, 3: Scan direction controlled frs Flat Field Reverse Set Set number 0-8 gcp Camera Configuration No value returned h Help No value returned rc Reset Camera No value returned roi Region of Interest Start pixel and end pixel numbers rpc Reset Pixel Coefficients No value returned sac Set AOI Count Number of AOI's 1-4 sad Last AOI Set AOI 1 Offset AOI 1 Width AOI 2 Offset AOI 2 Width ... sam Set AOI Mode 0: Disabled, 1: Enabled sbr Set Baud Rate No value returned scd Scan Direction 0: Internal, 1: External (CC3) control 0: Forward, 1: Reverse sem Exposure Mode 0: Internal, 1: External set Exposure Time ns smm Mirroring Mode 0: Enabled, 1:Disabled spf Pixel Format 0: RGB8, 1: RGB10, 2: RGB12 ssa Set Spatial Alignment 0 to 5 ssb Offset -512 to 511 12-bit DN ssf Internal Line Rate Hz ssg Gain (four lines) 0: System, 1: Red, 2: Green, 3: Blue, floating point numbers stm Trigger Mode 0: Internal, 1: External svm Test Pattern 0: sensor video, 1: mono ramp, 2: color ramp usd Default User Set Set number 0-8 usl Load User Set Last set loaded 0-8 uss Save User Set Last set saved 0-8 vt Temperature No value returned vv Input Voltage No value returned</pre>	

Full Name	Help
Mnemonic	H
Argument(s)	
Description	Display list of three letter commands
Notes	<pre> USER>h P4 (03-081-20294-92): Command Line Interpreter Oct 18 2013, 10:49:07 bwa - Balance white auto ccf - Calibrate User FPN <2048 4096> cls - Camera Link Speed <0 - 85MHz, 1 - 66MHz> clm - Camera Link Mode <0:Base 1:Med 2:Full 3:Deca 4:Dual Base> cms - Color matrix selector <device 0-Factory, 1-User> <Selector 1-2> cpa - Calibrate Flatfield <0:basic 1:filter><2048 4096><DN target> ctv - Color transformation value <0-Gain00/1-Gain01/2-Gain02/3- Gain10/.../8-Gain22/9-Offset1/10-Offset2/11-Offset3> f<value> dek - disable ESC key <0/1> ffm - Flat Field Mode <0:Off 1:On 2:Initialiaze 3:Scan direction controlled> frs - Set Flatfield Scan Direction Reverse Set <set 1-8> gcp - Display Camera Configuration get - Get value '<string>' h - Help lpc - Load Pixel Coefficients <set 0-8> rc - Reset Camera roi - Set Flatfield ROI <1st pixel> <last pixel> rpc - Reset Flatfield Coefficients sac - Set AOI Count <value 1-4> sad - Set AOI Selector, Offset and Width <selector 1-AOI Count> <1st pixel> <width >= 40> sam - Set AOI Mode <1-enable, 0-disable> sbr - Set Baud Rate <9600 19200 38400 57600 115200 230400 460800 921600> scd - Direction <0:Fwd, 1:Rev 2:Ext> scl - Select Exposure Time Color Selector <0-All,1-Red,2-Green,3- Blue,4-Mono> sem - Exposure Mode <0:Int 1:Ext> set - Set Exposure Time [ns]. See manual for restrictions on integration time smm - Mirroring <0:Off 1:On> spf - Pixel Format <0:RGB8 2:RGB12 3:BGR8 5:BGR12 6:RGB8+mono8 7:BGR8+mono8 8:RGB12+mono12 9:BGR12+mono12> ssa - Set Line Delay f<0-6> ssb - Offset <DN> ssf - Internal Line Rate <Hz> sha - Set horizontal alignment in float <0-Red, 1-Green> f<value 0-3> shm - Set horizontal alignment mode < 0-Off, 1-Active> ssg - Gain <0-System/1-Red/2-Green/3-Blue/4-Mono> f<gain> stm - External Trigger <0:Off 1:On> sui - Set User ID '<string>' svm - Test Pattern <0-2> usd - Default User Set <0-8> usl - Load User Set <0-8> uss - Save User Set <1-8> vt - Temperature vv - Input Voltage USER> </pre>

Full Name	Load Pixel Coefficients	
Mnemonic	LPC	
Argument(s)	Set selector	0. Factory set 1-8. User sets
Description	Load user set	
Notes	<ul style="list-style-type: none"> Loads FPN coefficients and PRNU coefficients from a user set (only coefficients, no other camera parameters) 	

Full Name	Reset Camera
Mnemonic	RC
Argument(s)	
Description	Resets the camera to the saved user default settings. These settings are saved using the <code>usd</code> command.
Notes	

Full Name	Set Binning Horizontal	
Mnemonic	SBH	
Argument(s)	Binning	1. Single pixel 2. Binning of 2 pixels
Description	Set horizontal binning	
Notes		

Full Name	Set Flatfield ROI	
Mnemonic	ROI	
Argument(s)	First pixel	1 to 4096 (2048, 2k)
	Last pixel	1 to 4096 (2048, 2k)
Description	Flat field region of interest	
Notes	<ul style="list-style-type: none"> Specifies the pixels that CCF and CPA will calibrate <ul style="list-style-type: none"> Pixel coefficients outside this region are not changed Last pixel must be greater than or equal to first pixel 	

Full Name	Reset Flatfield Coefficients	
Mnemonic	RPC	
Argument(s)		
Description	Reset all user FPN values to zero and all user PRNU coefficients to one	
Notes		

Full Name	Set AOI Count	
Mnemonic	SAC	
Argument(s)	Number of AOI's	1 to 4
Description	Set AOI Counter	
Notes		

Full Name	Set AOI Selector	
Mnemonic	SAD	
Argument(s)	Selector	1 to 4
	Offset	1 to 4096, multiple of eight
	Width	40 to 4096
Description	Define an AOI	
Notes	<ul style="list-style-type: none"> • Must not overlap with an already existing AOI 	

Full Name	Set AOI Mode	
Mnemonic	SAM	
Argument(s)	Mode	0. "Off" 1. "Active"
Description	Set AOI mode	
Notes		

Full Name	Set Baud Rate	
Mnemonic	SBR	
Argument(s)	Baud rate	9600 57600 115200 230400 460800 921600
Description	Set baud rate	
Notes	<ul style="list-style-type: none"> • Send command and then change speed of HyperTerminal 	

Full Name	Direction	
Mnemonic	SCD	
Argument(s)	Direction	<ul style="list-style-type: none"> 0. Forward 1. Reverse 2. External – controlled by CC3 signal
Description	Set sensor scan direction	
Notes		

Full Name	Select Exposure Time Color Selector	
Mnemonic	SCL	
Argument(s)	Color Selector	<ul style="list-style-type: none"> 0. All 1. Red 2. Green 3. Blue 4. Mono (2k model only)
Description	Select the color to apply an exposure time value to.	
Notes		

Full Name	Exposure Mode	
Mnemonic	SEM	
Argument(s)	Mode	<ul style="list-style-type: none"> 0. Internal 1. External
Description	Set exposure time mode	
Notes	<ul style="list-style-type: none"> • In internal mode the exposure time is controlled by the SET command • In external mode the sensor is exposed while CC1 signal is high • External mode is only available when the trigger mode is also external (STM 1) • SEM 1 overrides internally generated independent exposure times 	

Full Name	Exposure Time	
Mnemonic	SET	
Argument(s)	Exposure time	8 000 to 3000000 [ns]
Description	Set internal exposure time	
Notes	<ul style="list-style-type: none"> • Line time > (Exposure time + 1,500 ns) 	

Full Name	Set Horizontal Alignment	
Mnemonic	SHA	
Argument(s)	Selector	0. Red 1. Green
	Pixels	0 to 3
Description	The value entered will stretch the chosen color to align the colors.	
Notes		

Full Name	Set Horizontal Alignment Mode	
Mnemonic	SHM	
Argument(s)	Selector	0. Off 1. On
Description	Enable the horizontal correction	
Notes		

Full Name	Mirroring	
Mnemonic	SMM	
Argument(s)	Mode	0. Off 1. Image is flipped on the vertical axis
Description	Set mirroring mode	
Notes		

Full Name	Pixel Format	
Mnemonic	SPF	
Argument(s)	Selector	0. RGB8 (Trilinear & Quadlinear)
		1. RGB10 (Trilinear & Quadlinear)
		2. RGB12 (Trilinear & Quadlinear)
		3. BGR8 (Trilinear & Quadlinear)
		5. BGR12 (Trilinear & Quadlinear)
		6. RGB8+mono8 (Quadlinear only)
		7. BGR8+mono8 (Quadlinear only)
		8. RGB12+mono12 (Quadlinear only)
		9. BGR12+mono12 (Quadlinear only)
Description	Set pixel format	
Notes		

Full Name	Set Line Delay		
Mnemonic	SSA		
Argument(s)	# of lines	0 to 5	
Description	Sets the number of lines of delay between colors that are read out from the sensor (default 3).		
Notes	If your line rate matches the speed of the object, then the value of the line delay will be 3. Adjust the ssa value until you remove the red and blue halos above and below a black on white horizontal line in order to set the line delay. Values entered must be between 0 and 5. Decimal places are valid for sub-pixel correction.		

Full Name	Offset		
Mnemonic	SSB		
Argument(s)	Offset	8 bit 10-bit 12-bit	-32 to 31 -128 to 127 -512 to 511
Description	Set offset		
Notes	<ul style="list-style-type: none"> Range changes depending on pixel format (SPF) 		

Full Name	Internal Line Rate		
Mnemonic	SSF		
Argument(s)	Line rate	1 to 70,000 [Hz]	
Description	Set internal line rate		
Notes	<ul style="list-style-type: none"> Line time > (Exposure time + 1,500 ns) 		

Full Name	Gain		
Mnemonic	SSG		
Argument(s)	Selector	0. System 1. Red 2. Green 3. Blue 4. Mono (2k models only)	
	Gain	1 to 10	
Description	Set gain		
Notes	<ul style="list-style-type: none"> Multiplier must be immediately preceded with a "F" (e.g. ssg 0 f1.5) 		

Full Name	External Trigger	
Mnemonic	STM	
Argument(s)	Mode	0. Internal 1. External
Description	Set trigger mode	
Notes	<ul style="list-style-type: none"> In internal mode line rate is controlled by SSF command In external mode readout starts on falling edge of CC1 signal 	

Full Name	Test Pattern	
Mnemonic	SVM	
Argument(s)	Mode	0. Off – sensor video 1. Ramp 2. Color Ramp
Description	Select test pattern	
Notes	<ul style="list-style-type: none"> When a test pattern is selected all digital processing (e.g. flat field, gain) is disabled – it is re-enabled when sensor video is selected 	

Full Name	Default User Set	
Mnemonic	USD	
Argument(s)	Set selector	0. Factory set 1-8. User sets
Description	Select user set to load when camera is reset	
Notes	<ul style="list-style-type: none"> The settings include all those listed by the GCP command plus the user FPN coefficients, user PRNU coefficients, and color correction matrix 	

Full Name	Load User Set	
Mnemonic	USL	
Argument(s)	Set selector	0. Factory set 1-8. User sets
Description	Load user set	
Notes	<ul style="list-style-type: none"> Loads and makes current all the settings listed by the GCP command plus the user FPN coefficients, user PRNU coefficients, and color correction matrix 	

Full Name	Save User Set	
Mnemonic	USS	
Argument(s)	Set selector	1 to 8
Description	Save user set	
Notes	<ul style="list-style-type: none"> Saves all the current settings listed by the GCP command plus the user FPN coefficients, user PRNU coefficients, and color correction matrix 	

Full Name	Temperature	
Mnemonic	VT	
Argument(s)		
Description	Display internal temperature in degrees Celsius	
Notes		

Full Name	Voltage	
Mnemonic	VV	
Argument(s)		
Description	Display supply voltage	
Notes		

Appendix C: Quick Setup and Image Acquisition

If you are familiar with the operation of Camera Link cameras and have an understanding of imaging fundamentals, the following steps will show you how to quickly set up this camera and begin acquiring images.

1. On Power Up

The color camera has been calibrated and configured at the factory to be ready for your evaluation when first powered up. The default conditions are set as follows:

- System gain is set to the lowest value of one.
- Flat field calibration is *not* active as this feature is dependent on your light source and lens.
- Line rate and exposure time are set to for internal generation by the camera.
- White balance is set for white LEDs.
- Camera Link mode is set to the standard RGB medium mode which allows operation of up to 40 KHz line rate. The camera will run at up to a 68.5 KHz line rate using Camera Link Deca mode, but it may be easier to start your evaluation using the medium mode. Set your Camera Link frame grabber up to receive the standard RGB medium mode.

2. Communicating with the Camera

- The color camera is designed to power up with a GenICam-compliant interface.
- CamExpert provides an easy-to-use GUI that can be used to set up and evaluate the camera.
- The camera also comes with Teledyne DALSA's three letter command (TLC) interface option, which can be accessed using a suitable terminal program such as HyperTerminal™.
- If you want to use the TLC interface, press the 'Esc' key while using a terminal program and after the LED indicator on the camera turns green. Note that the camera defaults to 9.6 Kbaud when first powered up.
- On receiving the 'Esc' character, the camera will output a list of the available TLC commands. You can then proceed to enter TLC commands as required.
- Enter 'h' at any time to get the list of commands from the camera.

- Enter the 'gcp' command at any time to get the current setup conditions of the camera.

3. Setting Up Your Optical Configuration

Typically, the first thing you want to do is to evaluate the camera's image quality under operating conditions similar to those that you are likely to use in your application. In order to do this, take the following steps:

- The illumination, lens magnification, and focus should be set up as per you application.
- Getting the magnification right is best accomplished by setting the object-to-sensor distance. Use the formula $lens\ focal\ length \times (2 + 1/magnification + magnification)$ to calculate this distance. Magnification equals the sensor pixel size (10.56 μm) / (your object pixel size in μm).
- The approximate location of the sensor position is at the first groove in the side of the case, back from the front face.

4. Camera Timing & Control

It is easiest and quickest to evaluate the camera using the internal timing setups for line rate and exposure time.

- Since we recommend starting with Camera Link medium mode, set a suitable line rate less than 40 KHz, using the 'ssf' command.
- If this line rate is too slow for your application, you will get a compressed image in the scan direction. This should not be a problem for a basic evaluation.
- You can set the exposure time using the 'set' command. Ensure that the exposure time period is not greater than the period of the line rate minus 1.5 μsec .
- The camera will indicate an error if you select an exposure time that is too long. The minimum exposure time is 7 μsec .
- Set your camera direction using the 'scd' command. Refer to the Camera direction diagram in this manual for a definition of 'forward' and 'reverse'.

5. Acquiring an Image

You can now begin imaging. Unless you have an application employing lots of light, the image is likely to be too dark.

- Use the system gain to adjust the camera output to achieve the desired response. The system gain range is from 1x to 10x.
- Once you have a suitable response, you can now focus the lens.
- If you are using white LEDs, your image will have reasonable color reproduction.
- The image may be darker at the edges due to lens vignetting, but this will be improved once the camera is calibrated.

- Calibration is performed using a white reference where your object is normally located.
 - Use a white material that has no texture, such as a non glossy plastic.
 - If you must use white paper, make sure it is moving during the calibration process. If you do not do this, your image will have vertical stripes.
- Calibration is easily performed using the TLC 'cpa' command.
- The cpa command has two parameters.
 - The first is the number of lines you want to average over. Use a value of 4096* to achieve the best average.
 - The second is the eight bit target value you want for all three colors after calibration.
- The cpa command takes several seconds to complete. The slower the line rate, the longer it will take.
- On completion of the 'cpa' command, you should see an image from the camera that is white balanced with all three colors at the target level you set.

You are now ready to evaluate the image quality of the P4 color camera under your operating conditions.

6. Improving Your Color Image

The color response of the P4 color camera is quite good even when using white LED's and even without color correction. The camera has a factory set white LED color correction matrix that can be selected to improve color response for those using white LED's. If you are using a different light source, a suitable color correction matrix can be downloaded to the camera. A software tool to generate this is available with the Sapera Essentials processing applications, which can be downloaded from the Teledyne DALSA web site (60 day free trial). You will require a Gretag Macbeth ColorChecker with 4 x 6 color elements that you can scan past the camera to complete the generation of the matrix.

Contact Teledyne DALSA's technical support for further details; refer to the Contact Information section.

Appendix D: The Sensor Window

Cleaning and protecting against dust, oil, and scratches

The sensor window is part of the optical path and should be handled like other optical components, with extreme care. Dust can obscure pixels, producing dark patches on the sensor response. Dust is most visible when the illumination is collimated. The dark patches shift position as the angle of illumination changes. Dust is normally not visible when the sensor is positioned at the exit port of an integrating sphere, where the illumination is diffuse. Dust can normally be removed by blowing the window surface using an ionized air gun. Oil is usually introduced during handling. Touching the surface of the window barehanded will leave oily residues. Using rubber fingercots and rubber gloves can prevent contamination. However, the friction between rubber and the window may produce electrostatic charge that may damage the sensor. To avoid ESD damage and to avoid introducing oily residues, avoid touching the sensor. Scratches diffract incident illumination. When exposed to uniform illumination, a sensor with a scratched window will normally have brighter pixels adjacent to darker pixels. The location of these pixels will change with the angle of illumination.

An important note on window blemishes:

When flat field correction is performed, window cleanliness is paramount. The figure below shows an example of what can happen if a blemish is present on the sensor window when flat field correction is performed. The blemish will cast a shadow on the wafer. FFC will compensate for this shadow by increasing the gain. Essentially FFC will create a white spot to compensate for the dark spot (shadow). As long as the angle of the incident light remains unchanged then FFC works well. However when the angle of incidence changes significantly (i.e. when a lens is added) then the shadow will shift and FFC will make things worse by not correcting the new shadow (dark spot) and overcorrecting where the shadow used to be (white spot). While the dark spot can be potentially cleaned, the white spot is an FFC artifact that can only be corrected by another FFC calibration.

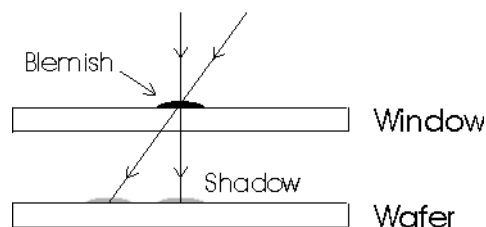

Cleaning the sensor window

Recommended Equipment

- Glass cleaning station with microscope within clean room.
- Ionized air gun. For example, 3M ionized air gun.
- Ionized air flood system, foot operated.
- Cotton swab. For example, Swab Huby340 CA-003.
- Single drop bottle (FD-2-ESD).
- Optic cleaning fluid. For example, the E2 Eclipse optic cleaning system.

Procedure

- Use localized ionized air flow directed on to the glass during sensor cleaning.
- Blow off mobile contamination using an ionized air gun.
- Place the sensor under the microscope at a magnification of 5x to determine the presence of any remaining contamination.
- Clean the contamination on the sensor using one drop of cleaning fluid on a swab.
- Wipe the swab from left to right (or right to left but only in one direction). Do this in an overlapping pattern, turning the swab after the first wipe and with each subsequent wipe. Avoid swiping back and forth with the same swab in order to ensure that particles are removed and not simply transferred to a new location on the sensor window. This procedure requires you to use multiple swabs.
- Discard the swab after both sides of the swab have been used once.
- Repeat until there is no visible contamination present.

Appendix E. Color Deca and Full Mode Acquisition

Overview

This section describes how to acquire images with the Piranha4 color camera under RGB 9.1 Deca mode to achieve a 68.5 KHz line rate, and under RGB 6.2 Full mode to achieve a 55 KHz line rate.

Supported Sopera LT

Sopera 7.10 or later is required.

Programming Deca Mode

The RGB 9.1 Deca mode uses Camera Link 10-tap, 8-bit mode to achieve RGB formatting. Below is the Camera Link port assignment of Deca mode.

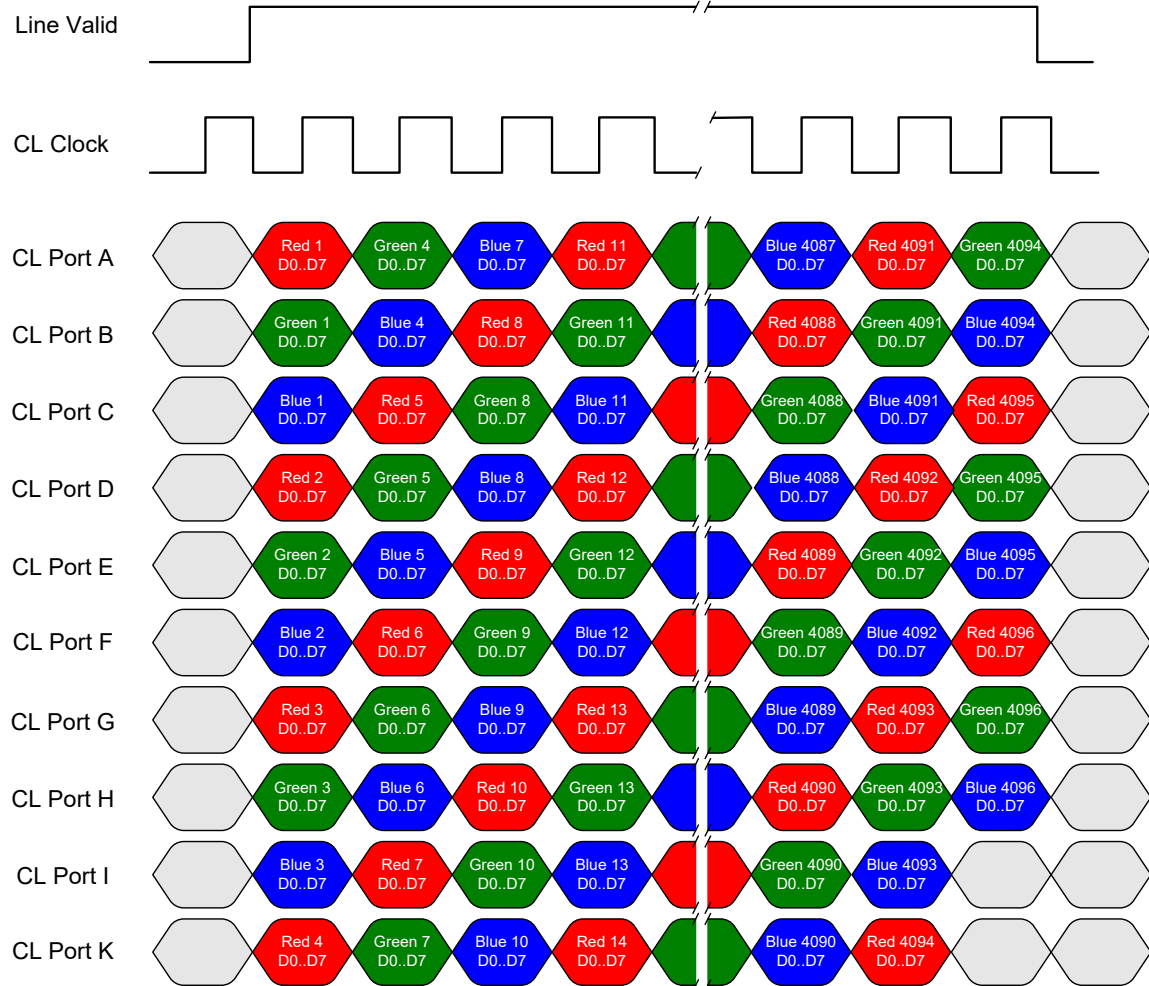

Acquiring the above data as you would an 8-bit mono camera in 10-tap mode creates the acquisition buffer shown below.

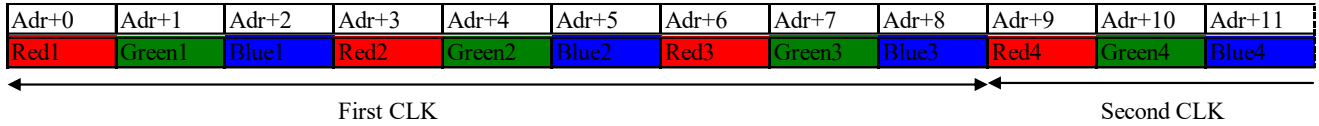

On the other hand, the SapFormatRGR888 format is shown below.



As you demonstrated above, the two buffers' content and their order are exactly same. Thus, acquiring the buffer as if the camera were a mono 8-bit, 10-tap results in the same buffer contents as the SapFormatRGR888.

Sample code:

```
//Assuming acquisition buffer is declared as below.
#define NUMBUFFERS 10
SapBuffer *m_Buffers;
m_Buffers = new SapBufferWithTrash(NUMBUFFERS, m_Acq);

// Call Create() for acquisition buffer
m_Buffers->Create();

// Declare SapBuffer object which shares buffer components with the acquisition buffer
SapBuffer *m_ViewBuffers;
int width, height, i;
void* pData[NUMBUFFERS];
for (i=0; i<NUMBUFFERS; i++)
{
    m_Buffers->GetAddress(i, &pData[i]);
}
width = m_Buffers->GetWidth();
height = m_Buffers->GetHeight();
m_ViewBuffers = new SapBuffer(NUMBUFFERS, pData, width / 3, height, SapFormatRGR888);
m_ViewBuffers->Create();
If you declare above m_ViewBuffer as the source buffer of SapView object, you can display RGB image
without any additional processing.
```

Programming Full Mode

The RGB 6.2 Full mode utilizes Camera Link 8-tap, 8-bit mode to achieve RGB formatting. Below is the Camera Link port assignment of Full mode.

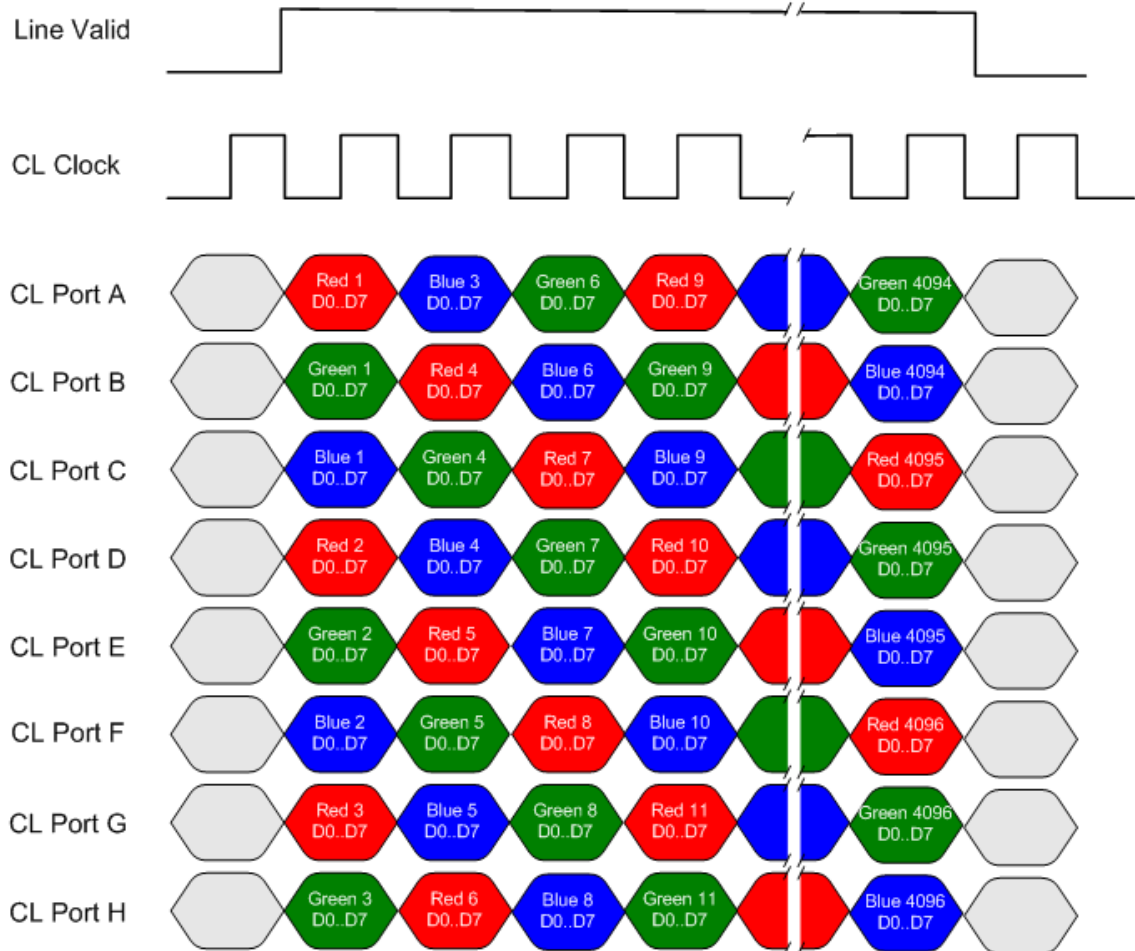

This tap arrangement allows all frame grabbers with 8-tap, 8-bit to grab images without requiring additional modifications.

However, in order to correctly format the image for processing and display purposes, frame grabbers need to support RGB 6.2 mode natively. Until then, here are some workarounds using Sopera LT.

Notice, to support this pixel format in memory, the buffer must be set to RGB 24-bit packed.

All Sopera demo and example programs extract the create acquisition buffer type from the associated camera configuration files. Until there is native support for RGB 6.2 mode, frame grabbers must be configured as monochrome, the CCF files pixel format can't be used by the programs to process the image correctly.

A simple workaround accomplishes this:

- 1) Acquire as if the P4 camera was a 8-bit mono, 24,576 (4096 x 3) pixels linescan camera
- 2) Treat acquired buffer as SapFormatRGR888 (24bit/pixel). Spera LT provides a feature to share buffer components between two SapBuffer objects. Buffer type may be different between the two SapBuffer objects. This can be a trick to convert buffer format without buffer copy.

Acquiring the above data as you would an 8-bit mono camera in 8-tap mode creates the acquisition buffer shown below.

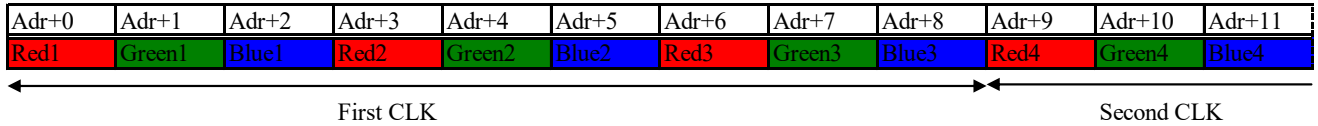

On the other hand, the SapFormatRGR888 format is shown below.



As you demonstrated above, the two buffers' content and their order are exactly same. Thus, acquiring the buffer as if the camera were a mono 8-bit, 8-tap results in the same buffer contents as the SapFormatRGR888.

Sample code:

```
//Assuming acquisition buffer is declared as below.
#define NUMBUFFERS 8
SapBuffer *m_Buffers;
m_Buffers = new SapBufferWithTrash(NUMBUFFERS, m_Acq);

// Call Create() for acquisition buffer
m_Buffers->Create();

// Declare SapBuffer object which shares buffer components with the acquisition buffer
SapBuffer *m_ViewBuffers;
int width, height, i;
void* pData[NUMBUFFERS];
for (i=0; i<NUMBUFFERS; i++)
{
    m_Buffers->GetAddress(i, &pData[i]);
}
width = m_Buffers->GetWidth();
height = m_Buffers->GetHeight();
m_ViewBuffers = new SapBuffer(NUMBUFFERS, pData, width / 3, height, SapFormatRGB888);
m_ViewBuffers->Create();
```

If you declare above m_ViewBuffer as the source buffer of SapView object, you can display RGB image without any additional processing.

Appendix F: Camera, Frame Grabber Communication

Setting up communication between the camera and the frame grabber

Teledyne DALSA Camera Link cameras support the GenCP Camera Link standards.

To configure Teledyne DALSA GenCP Camera Link Cameras:

1. Install the Teledyne DALSA frame grabber in the host computer; refer to the hardware installation manual.
2. Install Sopera LT and the Teledyne DALSA frame grabber driver.
3. Connect the camera to the frame grabber; refer to the camera installation manual.
4. Power up the camera and wait until the status LED is solid green.
5. Run the Sopera Configuration utility and select the frame grabber serial port connected to the camera. Set **Teledyne DALSA camera detection** to **Automatic Detection** and **Baud rate** to **Auto Detect & Maximize**.
6. If the camera will be configured using three-letter text commands via a terminal program, such as HyperTerminal, then set **COM port mapping (optional)** to an available COM port (e.g. COM2).

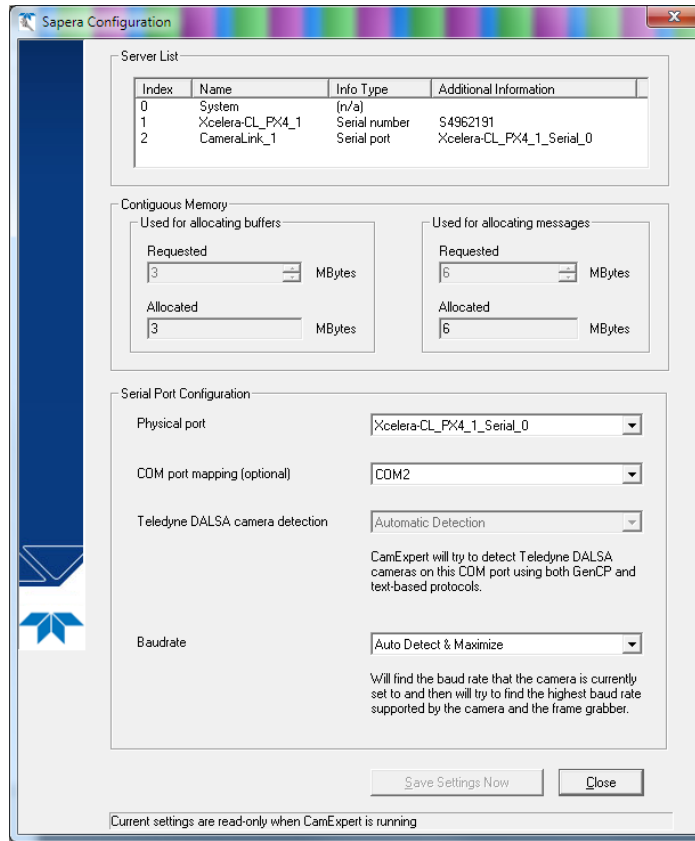

7. Start the CamExpert application. In the **Device** tab, select **CameraLink Medium Color RGB #1**.

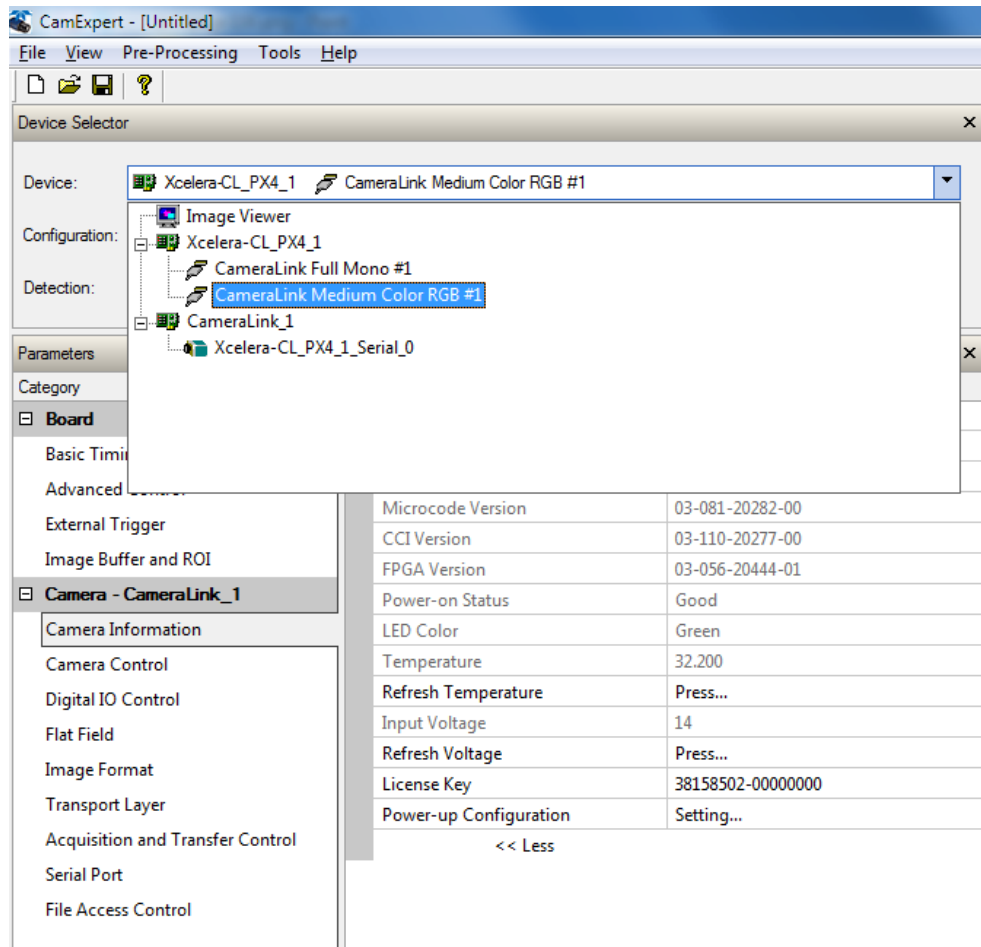

- Modify the camera and frame grabber parameter settings as required. At present, when using GenCP cameras, the camera and frame grabber parameters must be adjusted separately. Test the image acquisition by clicking the **Grab** button.



- Save the frame grabber configuration to a new *.ccf file.

Appendix C: Error and Warning Messages

BiST: Built in Self-Test

The BiST error flags are binary flags with each bit being independent from each other. The message from the BiST should be “Good” meaning everything is functioning correctly but if a hardware failure does occur in the camera one or more these flags could be set. Any of these errors will result in the status light turning red.

Definition	BiST Flag
I2C error	1
Unable to configure fpga	10
Unable to configure fpga	100
EXT_SRAM Failure	1000
ECHO_BACK Failure	1,0000
FLASH_TIMEOUT	10,0000
FLASH_ERROR	100,0000
NO_FPGA_Code	1000,0000
NO_COMMON_SETTINGS	1,0000,0000
NO_FACTORY_SETTINGS	10,0000,0000
NO_USER_SETTINGS	100,0000,0000
NO_FLAT_FIELD Corrections	1000,0000,0000
NO MISC corrections	1,0000,0000,0000
NO_FPN Correction	10,0000,0000,0000
NO_FPN Correction	100,0000,0000,0000
NO_PRNU Correction	1000,0000,0000,0000
NO_FEED Through Correction	1,0000,0000,0000,0000
NO_LINEARITY Correction	10,0000,0000,0000,0000
SYNC_ERROR	100,0000,0000,0000,0000
OVER_TEMPERATURE	1000,0000,0000,0000,0000
SPI Failure	1,0000,0000,0000,0000,0000
NO_USER_FPN	10,0000,0000,0000,0000,0000
PLL_LOCK_FAILED	100,0000,0000,0000,0000,0000
INVALID_CCI	1000,0000,0000,0000,0000,0000
No LUT	1,0000,0000,0000,0000,0000,0000
Incompatible FPGA code	10,0000,0000,0000,0000,0000,0000

Operational Error Codes

Code	Description
0X8002	Invalid Parameter
0xC01C	CPA_TOO_MANY_OUTLIERS
0x401E	USER_FPN_CLIPPING
0x401F	FLAT_FIELD_CLIPPING

Declarations of Conformity

Copies of the Declarations of Conformity documents (for example, EU, FCC & ICES Supplier and Material Composition Product Declaration) are available on the product page on the [Teledyne DALSA website](#) or by request.

FCC Statement of Conformance

This equipment complies with Part 15 of the FCC rules. Operation is subject to the following conditions:

1. The product may not cause harmful interference; and
2. The product must accept any interference received, including interference that may cause undesired operation.

FCC Class A Product

This equipment has been tested and found to comply with the limits for a Class A digital device, pursuant to part 15 of the FCC Rules. These limits are designed to provide reasonable protection against harmful interference when the equipment is operated in a commercial environment. This equipment generates, uses, and can radiate radio frequency energy and, if not installed and used in accordance with the instruction manual, may cause harmful interference to radio communications. Operation of this equipment in a residential area is likely to cause harmful interference in which case the user will be required to correct the interference at his own expense.

Changes or modifications not expressly approved by the party responsible for compliance could void the user's authority to operate the equipment.

This equipment is intended to be a component of a larger industrial system.

EU and UKCA Declaration of Conformity

Teledyne DALSA declares that this product complies with applicable standards and regulations.

Changes or modifications not expressly approved by the party responsible for compliance could void the user's authority to operate the equipment.

This product is intended to be a component of a larger system and must be installed as per instructions to ensure compliance.

Revision History

Revision	Change Description	Date
00	Release of the initial manual revision.	17 April 2013
01	<ul style="list-style-type: none"> - RGB10 and RGB12 pixel formats added. - Trigger source and trigger mode parameters removed from manual. - RGB10 and RGB12 added to SPF command. - Full and Deca timing diagrams revised. - Formatting revisions. 	10 May 2013
02	<ul style="list-style-type: none"> -2K resolution and Quadlinear models added to the manual. -QE graphs revised. -Binning sections added (4K cameras only). 	7 February 2014
03	<ul style="list-style-type: none"> -Update to lens mount accessories table. -Dead links removed from Appendix D: Sensor Window Cleaning instructions. A general description of the recommended equipment substituted. -References to “trinity” and “quad” replaced with trilinear and quadlinear. 	23 June 2015
04	Small body 2k and 4k (P4-CC-04K04T-01-R and P4-CC-02K04T-01-R) camera models and supporting information added to the manual.	4 January 2018
05	<ul style="list-style-type: none"> -Size specifications for the small body cameras revised to 62 mm x 62 mm x 37 mm . Previous depth spec (31 mm) did not include connectors. -Environmental specifications added. 	2 May 2018
06	<ul style="list-style-type: none"> -RGB 12 bit CL Deca, maximum line rate value revised to 41.5 kHz (4K) from 69. -EC & FCC Declaration of Conformity updated to include P4-CC-02K04T-01-R and P4-CC-04K04T-01-R camera models. 	3 May 2019
07	-Updated Declarations of Conformity.	1 October, 2021

Contact Information

Sales Information

Visit our web site:

www.teledynedalsa.com

Email:

info@teledynedalsa.com

Canadian Sales

Teledyne DALSA — Head office
605 McMurray Road
Waterloo, Ontario, Canada, N2V 2E9
Tel: 519 886 6000
Fax: 519 886 8023

Teledyne DALSA — Montreal office
880 Rue McCaffrey
Saint-Laurent, Quebec, Canada, H4T 2C7
Tel: (514) 333-1301
Fax: (514) 333-1388

USA Sales

Teledyne DALSA — Billerica office
700 Technology Park Drive
Billerica, Ma. 01821
Tel: (978) 670-2000
Fax: (978) 670-2010
sales.americas@teledynedalsa.com

European Sales

Teledyne DALSA GMBH
Lise-Meitner-Str. 7
82152 Krailling (Munich), Germany
Tel: +49 – 89 89545730
sales.europe@teledynedalsa.com

Asian Pacific Sales

Teledyne DALSA Asia Pacific
Ikebukuro East 6F
3-4-3 Higashi Ikebukuro,
Toshima-ku, Tokyo, Japan
Tel: +81 3 5960 6353
Fax: +81 3 5960 6354
sales.asia@teledynedalsa.com

Teledyne DALSA Asia Pacific
Room 904, Block C, Poly West Bund Center
75 Rui Ping Road
Shanghai 200032
Tel: +86-21-60131571
sales.asia@teledynedalsa.com

Technical Support

Submit any support question or request via our web site:

Technical support form via our web page:
Support requests for imaging product installations,
Support requests for imaging applications

Camera support information

Product literature and driver updates

<https://www.teledynedalsa.com/en/support/options/>