

❖ LQ-401CL

4 CMOS RGB/NIR Line Scan Camera



- 4 CMOS line scan camera with Camera Link output
- Dichroic RGB/NIR beam splitter prism with 4 sensors
- 4 sensors with 4096 pixels, 7 μm x 7 μm
- Low-noise operation (S/N: 55 dB) providing superior image quality
- 28.672 mm sensor scan width
- 4 x 8 bits or 4 x 10 bits output through Camera Link interface
- Line rate up to 18252 lines per second at 84 MHz pixel clock
- One-push auto white balance
- Flat field correction and color shading correction
- Knee and binning functions for extended dynamic range and sensitivity
- Sub-sampling and windowing readout
- Set-up and installation aid with built-in test generator
- Available with M52 mount (standard) or Nikon F-mount
- Short ASCII commands for set-up via RS 232C or Camera Link
- Setup by Windows software



Specifications for LQ-401CL

Specifications		LQ-401 CL
Scanning system	Line sensor with internal clock	
Pixel clock	84.00 MHz	
Line rate	Standard	54.79µs (Full resolution/binning/internal trigger)
	Programmable	54.79µs~14.30ms, 11.9ns increments
Sensor	4 CMOS line sensors mounted on R/G/B/NIR beam splitter prism	
Sensor scanning width	28.672 mm	
Cell size	7 µm x 7 µm	
Active pixels	4 x 4096 (h)	
	4 x 2048 (h) with 2:1 binning	
Sensor sensitivity	Radiometric: 64nJ/cm ²	
Sensitivity	2800 Lux (7800K, gain=low, shutter=OFF, 100% video)	
S/N ratio	55 dB on green with gain = 0 dB	
Video output	4 x 8 bit in CL base configuration 4 x 10 bit in CL medium configuration	
Gain	Master tracking	Master: 0 dB to +8 dB R/B: -4 dB to +6 dB
	Individual mode	Analog gain= Low (0dB) or High (+6dB) R/G/B: -4 dB to +14 dB Analog gain= Low (0dB) or High (+6dB)
White balance	Manual, fixed or one-push Adjustable range 4000 K to 9000 K Fixed: 4000 K, 4600 K or 5600 K	
Shading correction	Individual R/G/B/NIR flat or R/B/NIR to G	
Flat-field correction	PRNU Correction: Built-in DSNU Correction: Built-in	
Synchronization	Internal X-tal or external trigger	
Trigger modes	No-shutter, shutter-select and pulse width control	
Programmable exposure	9.52 µs to 14.2 msec. in 11.9 ns increments	
Functions controlled by RS 232C or CL	Trigger modes, scan rate, exposure time, gain/black level, shading correction, flat-field correction, white balance, knee-function, diagnostics	
Diagnostics	Test pattern generator. (Color bar, gray pattern and white) LED for power	
Lens mount	M-52 mount. (Standard) Nikon F-mount. (Factory option)	
Sensor alignment	Better than ±0.1 pixel (at center)	
Operating temperature	-5°C to +45°C/20 – 80% non-condensing	
Storage temp./humidity	-25°C to +60°C/20 – 80% non-condensing	
Vibration	3G (20Hz to 200Hz, XYZ direction)	
Shock	50G	
Regulations	Emission: CE CISPR Pub. 22 (EN55022) Immunity: CISPR Pub. 24 IEC61000-4-2 Conforming level 4 FCC Part15 Class B RoHS	
Power	12V DC to 24V DC ± 10%.	
Dimensions (H x W x D)	90 mm x 90 mm x 120 mm (without connector and lens mount protrusion)	
Weight	1050 g	

Ordering Information

LQ-401 CL-M52	4 CMOS RGB/NIR Line Scan Camera. P-mount (M52)
LQ-401 CL -F	4 CMOS RGB/NIR Line Scan Camera. F-mount

Connection Pin-out

DC In / Trigger

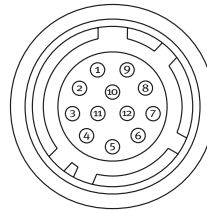

HIROSE HR10A-10R-12PB-71

Pin 1	Ground
Pin 2	+12V to +24V DC
Pin 3	Ground
Pin 4	Reserved
Pin 5	Ground
Pin 6	RXD RS 232C*
Pin 7	TXD RS 232C*
Pin 8	Ground
Pin 9	XEEN output
Pin 10	Trigger input (TTL)*
Pin 11	DC in +12V to +24V
Pin 12	Ground

Camera Link Interface

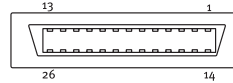

Pin	Signal	Function
1	14	GND
2	15	X ₀ -/X ₀ + CL Data
3	16	X ₁ -/X ₁ + CL Data
4	17	X ₂ -/X ₂ + CL Data
5	18	Xclk-/Xclk+ CL Clk
6	19	X ₃ -/X ₃ + CL Data
7	20	SerTC+/SerTC- Serial in *
8	21	SerTFG-/SerTFG+ Serial out *
9	22	CC1-/CC1+ Trigger *
10	23	CC2-/CC2+ Reserved
11	24	CC3-/CC3+ Not used
12	25	CC4-/CC4+ Not used
13	26	GND

* In Camera Link or 12 pin Hirose

Note:

Camera Link base configuration shown.
For medium configuration refer to Camera Link specifications or operation manual.

Spectral Response

LQ-401CL CAMERA Sensitivity

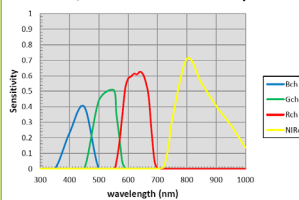

Dimensions

Front view

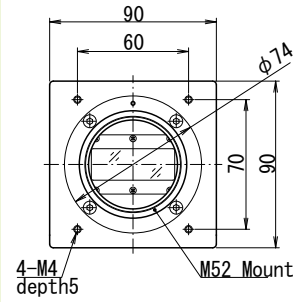

Side view

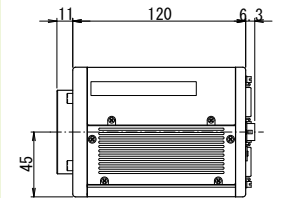

Bottom view

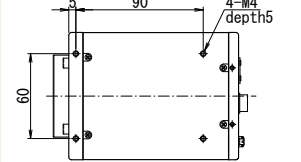

Rear view

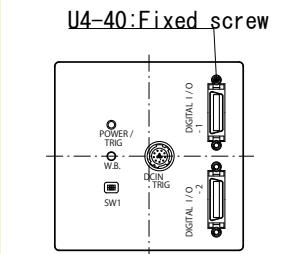

Europe, Middle East & Africa
Phone +45 4457 8888
Fax +45 4491 8880

Asia Pacific
Phone +81 45 440 0154
Fax +81 45 440 0166

Americas
Phone (Toll-Free) 1 800 445 5444
Phone +1 408 383 0300

Visit our web site on www.jai.com

See the possibilities

